

# The Inside Hospitality

**CATÁLOGO**  
*CATALOGUE*

**Ghessu**  
★★★★★



# Ghessu



# NOSOTROS

## *About us*

Con más de 25 años de experiencia en la fabricación de equipamiento para hoteles y colectividades, en Ghessu somos especialistas en ofrecer soluciones de alta calidad y personalizadas.

Nos enfocamos en cadenas hoteleras, hoteles y colectividades, fabricando nuestros productos en nuestras propias instalaciones y permitiéndonos adaptarlos a las necesidades específicas de cada cliente.

Nuestro objetivo es transformar espacios en ambientes de comodidad, confort y seguridad. En Ghessu garantizamos acabados que se integran perfectamente en cualquier diseño, consolidándonos como líderes en equipamiento en el sector hospitality.

*With more than 25 years of experience in the manufacture of equipment for hotels and collectivities, at Ghessu we are specialists in offering high quality and customised solutions.*

*We focus on hotel groups, hotels and collectivities, manufacturing our products in our own facilities and allowing us to adapt them to the specific needs of each client.*

*Our aim is to transform spaces into environments of comfort, convenience and safety. At Ghessu we guarantee finishes that integrate perfectly into any design, consolidating our position as leaders in equipment for the hospitality industry.*



*JW Marriot (Madrid, España)*



*TRS Coral Hotel (Costa Mujeres, México)*

# NUESTROS CLIENTES

*Our clients*



# NUESTRA MISIÓN

## *Our mission*

En Ghessu apostamos por ofrecer soluciones de calidad excepcional a través de una amplia gama de productos fabricados principalmente en España.

Trabajamos con materiales nobles como el acero inoxidable, el latón y el cobre, y colaboramos con proveedores de contrastada cualificación y calidad tanto a nivel nacional como internacional.

Nuestro compromiso con el cliente y nuestra atención al detalle garantizan un servicio personalizado y excepcional, atendiendo a más de 80 países con nuestra red local y a través de nuestra red de distribuidores.

*At Ghessu, we are committed to offering exceptional quality solutions through a wide range of products mainly manufactured in Spain.*

*We work with noble materials such as stainless steel, brass and copper, and we collaborate with suppliers of proven qualification and quality both nationally and internationally.*

*Our commitment to the customer and our attention to detail guarantees a personalised and exceptional service, serving more than 80 countries with our local network and through our network of distributors.*



# NUESTRA VISIÓN

## *Our vision*

Convertirnos en referente internacional cuando hablamos de soluciones de fabricación personalizadas, donde la calidad, la innovación y el compromiso con el cliente sean el eje de nuestra actividad, inspirando confianza y satisfacción en cada uno de los hoteles alrededor del mundo.

*To become an international reference in customised manufacturing solutions, where quality, innovation and commitment to the customer are at the heart of our business, inspiring confidence and satisfaction in every hotel and facility around the world.*



# NUESTROS VALORES

## *Our values*



### Desarrollo e innovación

Nuestro equipo diseña, desarrolla e innova soluciones de alta calidad y diseño para el sector hotelero, con el objetivo de crear espacios cómodos, innovadores y funcionales para los huéspedes y el personal de hoteles de todo el mundo.

### Development and innovation

*Our team designs, develops and innovates high quality and design solutions for the hospitality industry, aiming to create comfortable, innovative and functional spaces for guests and staff in hotels around the world.*

### Nuestro equipo

Contamos con un equipo de personas altamente cualificadas y motivadas que forman sinergias que se traducen en calidad laboral, una excelente cultura de empresa y un fuerte vínculo de compromiso. Trabajamos con ambientes flexibles y de conciliación familiar, poniendo a nuestros trabajadores en primer lugar.

### Our team

*We have a team of highly skilled and motivated people who create synergies that translate into quality work, an excellent culture and a strong commitment to the company. We work with flexible environments and family reconciliation, putting our people first.*

### Personalización

Nuestra condición de fabricante nos otorga un amplio margen para la personalización, acomodación y versatilidad de nuestros productos. Adaptando medidas, acabados, formas y dando luz a innovaciones como si fueran un traje a medida.

### Personalisation

*Our status as a manufacturer gives us great scope for customisation, adaptation and versatility of our products. We can adapt sizes, finishes and shapes and bring innovation to life as if it were a made-to-measure suit.*



### Fabricado en España

El alma de nuestra marca es el compromiso de la fabricación nacional de nuestros productos, trabajados en acero inoxidable, que resultan en accesorios para baños y complementos para habitaciones de hoteles.

### Manufacture in Spain

*The soul of our brand is the commitment to the national manufacture of our products, made of stainless steel, brass, etc. which results in top quality raw materials for bathroom accessories and hotel room complements.*

### Sostenibilidad

Miramos al futuro como empresa que escucha y que avanza por trabajar con procesos eficientes y sostenibles. Nos enfocamos en la calidad y durabilidad de nuestros productos, alargando su vida útil y reduciendo su proceso de refabricación.

### Sustainability

*We look to the future as a company that listens and moves forward by working with efficient and sustainable processes. We focus on the quality and durability of our products, extending their useful life and reducing the need for remanufacturing.*

### Orientación al cliente

Las personas que trabajan en Ghessu y todos los procesos laborales están enfocados a proporcionar la mejor atención al cliente. Desde la generación de información, la resolución de dudas, la atención de incidencias y la gestión comercial, acompañamos a cada cliente en su experiencia con nosotros.

### Customer focus

*The people who work at Ghessu and all the work processes are focused on providing the best customer service. From the generation of information to the resolution of doubts, from the management of incidents to commercial management, we accompany each customer in their experience with us.*





# Índice

## Index

<b>Acc. baño latón / Brass bathroom acc.</b> .....	<b>14</b>	<b>Complementos inroom / Inroom complements</b> .....	<b>252</b>
MOON .....	17	Papeleras - Wastebaskets .....	254
KUO .....	31	Higiene - Hygienic .....	260
METRO .....	45	Gama polipiel - Leatherette line .....	262
CUBIK .....	53	Hervidores - Kettles .....	272
NOA .....	75	Reposamaletas - Luggage racks .....	280
AIR .....	85	Banquetas - Stools .....	286
AVANT .....	99	Básculas - Scales .....	288
SFERA .....	107	Perchas - Hangers .....	290
Carros - Trolleys .....	116	Tendedores - Clothesline .....	296
Repisas - Shelves .....	120	<b>Complementos outroom / Outroom complements</b> .....	<b>298</b>
<b>Acc. baño inox / Stainless steel acc.</b> .....	<b>124</b>	Secamanos - Hand dryers .....	300
LINER .....	127	Dispensadores - Dispensers .....	304
NORMAX .....	141	Cambiapañales y compreseros - Baby changing tables and sanitary pedal .....	312
MINOX .....	151	Papeleras - Trash .....	314
Repisas - Shelves .....	158	Carros limpieza - Cleaning trolleys .....	320
Cubos - Bins .....	164	<b>Ayudas técnicas / Technical aids</b> .....	<b>322</b>
<b>Espejos de aumento / Magnifying mirrors</b> .....	<b>168</b>	Inox - Stainless steel .....	324
LED pared - Wall-mounted LED light .....	170	PVC .....	332
Sin luz pared - Wall-mounted without light .....	176	Espejos - Mirrors .....	336
LED sobremesa - Free standing LED light .....	182	Sanitarios geriatría - Geriatric sanitary ware .....	338
Sin luz sobremesa - Free standing without light .....	184		
Decor glass .....	186		
<b>Secadores / Hairdryers</b> .....	<b>194</b>		
Secadores - Hairdryers .....	196		
Planchas - Hair straighteners .....	232		
<b>Centros de planchado / Ironing centres</b> .....	<b>238</b>		
Black line premium .....	242		
Black line .....	244		
Pablo .....	245		
Cepillo de vapor - Steam brush .....	244		
Ocean premium .....	250		

# El Latón *Laton*



**Funde a 980°**  
*It melts at 980°*

**Muy moldeable**  
*Highly mouldable*

**Buena plasticidad**  
*Good plasticity*

**Buena estampación en caliente**  
*Good hot stamping*

**Buen conductor térmico**  
*Good thermal conductivity*



**Corrosión**  
*Corrosion*

**Buena resistencia a la corrosión**  
*Good corrosion resistance*

**Ideal para uso en baños**  
*Ideal for use in the bathroom*

**Excelente soldadura**  
*Excellent weldability*

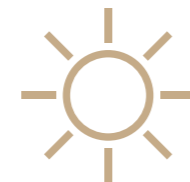

**Resistencia**  
*Resistance*

**No se altera entre -100° y 200°**  
*Does not alter between -100° and 200°*

**No se degrada con la luz**  
*Does not degrade with light*



**Sostenibilidad**  
*Sustainability*

**Reciclable y reutilizable**  
*Recyclable and reusable*

**Residuos seleccionables y fundibles de nuevo**  
*Selectable and re-meltable waste*

## Acabados especiales - *Special finishes*

Latón cepillado  
*Brushed brass*



Cobre cepillado  
*Brushed copper*



Negro mate  
*Matte black*



Níquel brillo  
*Bright nickel*



Negro cromo  
*Chrome black*



Gun metal  
*Gun metal*



Latón antiguo  
*Antique brass*

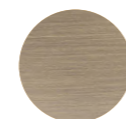

# Accesorios de baño en latón

*Brass bathroom accessories*



MOON 17

KUO 31

METRO 45

CUBIK 53

NOA 75

AIR 85

AVANT 99

SFERA 107

CARROS 116

*Trolleys*

REPISAS 120

*Towel Shelves*

# MOON

MOON es una serie protagonista con un diseño minucioso y versátil que ofrece infinitas posibilidades de composición. Cada pieza se convierte en un diseño puro, una línea esencial de calidad extraordinaria.

Una serie disponible en negro mate con elegantes detalles en tres diferentes acabados:

- Negro brillante
- Oro brillante
- Cobre brillante

Un toque de elegancia que eleva el diseño de las zonas de baño.

*MOON is a leading series with a meticulous and versatile design that offers infinite compositional possibilities. Each piece becomes a pure design, an essential line of extraordinary quality.*

*A series available in matt black with elegant details in three different finishes:*

- **Bright black**
- **Bright gold**
- **Bright copper**

*A touch of elegance that elevates the design of bathroom areas.*

Los acabados especiales, cobre cepillado y latón cepillado, cuentan con un recubrimiento PVD (deposición física de vapor), que proporciona una mayor resistencia a la corrosión, asegurando una longevidad superior y manteniendo un aspecto impecable incluso con un uso intensivo.

La serie está disponible en los siguientes acabados:  
Para otros acabados, consultar con equipo comercial.

*The special finishes, brushed copper and brushed brass, feature a PVD (physical vapor deposition) coating, which provides increased corrosion resistance, ensures superior longevity and maintains a flawless appearance even with intensive use.*

*Series available in the following finishes:  
For other finishes, please contact our sales team.*

**Negro mate & negro brillo**  
*Matte black & Bright black*

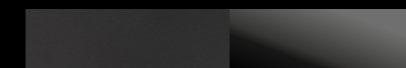

**Negro mate & oro brillo**  
*Matte black & Bright gold*



**Negro mate & cobre brillo**  
*Matte black & Bright copper*

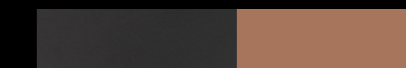

# MOON negro mate negro brillo

*matte black  
bright black*

**Perchas  
Portarrollos  
Toalleros  
Dispensadores  
Escobilleros**

*Hangers  
Toilet roll holders  
Towel racks  
Dispensers  
Toilet brush holders*

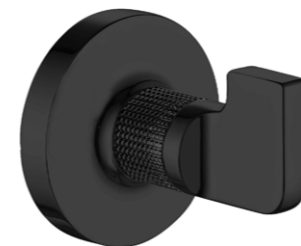

**190000-N** ●●●●  
Percha 90° MOON.  
Acabado: negro mate y negro brillo.  
Material: latón.  
90° robe hook MOON.  
Finish: matte black and bright black.  
Material: brass.  
62 x 60 x 68 mm.



**190100-N** ●●●●  
Portarrollos sin tapa MOON.  
Acabado: negro mate y negro brillo.  
Material: latón.  
Toilet roll holder without lid MOON.  
Finish: matte black and bright black.  
Material: brass.  
60 x 180 x 79 mm.



**190200-N** ●●●●  
Portarrollos reserva MOON.  
Acabado: negro mate y negro brillo.  
Material: latón.  
Reserva toilet roll holder MOON.  
Finish: matte black and bright black.  
Material: brass.  
182 x 60 x 92 mm.



**190300-N** ●●●●  
Portarrollos con tapa bandeja móvil MOON.  
Acabado: negro mate y negro brillo.  
Material: latón.  
Toilet roll holder with lid tray for mobile MOON.  
Finish: matte black and bright black.  
Material: brass.  
70 x 180 x 110 mm.

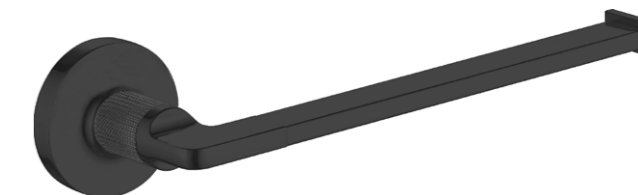

**190400-N** ●●●●  
Toallero bidé MOON o portarrollos doble.  
Acabado: negro mate y negro brillo.  
Material: latón.  
Towel bidet MOON or double toilet roll holder.  
Finish: matte black and bright black.  
Material: brass.  
60 x 245 x 76 mm.

Estructura de dimensiones. alto/ancho/fondo.  
Dimension structure. height/width/depth.



**190500-N** ●●●●

Toallero barra 45 cm MOON.  
Acabado: negro mate y negro brillo.  
Material: latón.  
Towel bar 45 cm MOON.  
Finish: matte black and bright black.  
Material: brass.  
60 x 515 x 75 mm.



**190600-N** ●●●●

Toallero barra 60 cm MOON.  
Acabado: negro mate y negro brillo.  
Material: latón.  
Towel bar 60 cm MOON.  
Finish: matte black and bright black.  
Material: brass.  
60 x 660 x 75 mm.



**191000-N** ●●●●

Portavasos a pared MOON.  
Acabado: negro mate y negro brillo.  
Material: latón y cristal arenado.  
Wall mounted tumbler holder MOON.  
Finish: matte black and bright black.  
Material: brass & sandblasted glass.  
99 x 67 x 119 mm.



**191100-N** ●●●●

Jabonera a pared MOON.  
Acabado: negro mate y negro brillo.  
Material: latón y cristal arenado.  
Wall mounted soap dish MOON.  
Finish: matte black and bright black.  
Material: brass & sandblasted glass.  
60 x 110 x 140 mm.

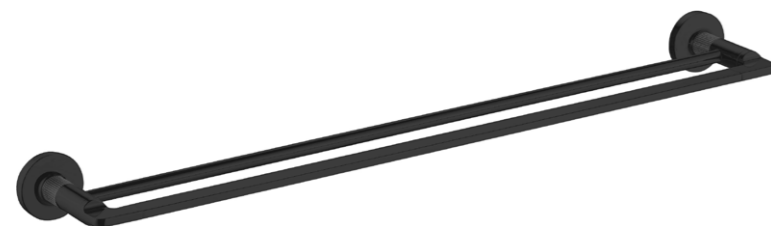

**190800-N** ●●●●

Toallero doble barra 60 cm MOON.  
Acabado: negro mate y negro brillo.  
Material: latón.  
Double towel bar 60 cm MOON.  
Finish: matte black and bright black.  
Material: brass.  
60 x 660 x 121 mm.

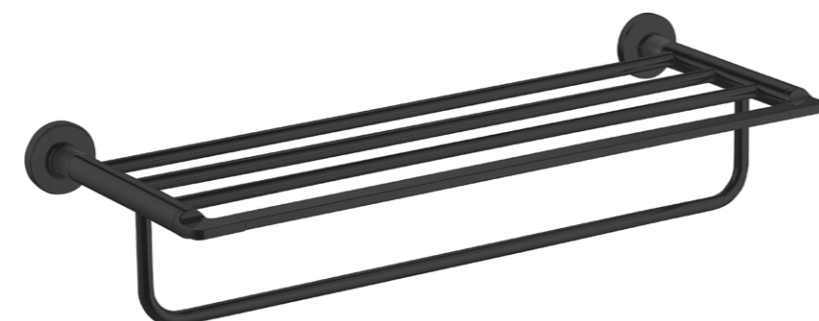

**190900-N** ●●●●

Toallero repisa MOON.  
Acabado: negro mate y negro brillo.  
Material: latón.  
Towel shelf MOON.  
Finish: matte black and bright black.  
Material: brass.  
119 x 660 x 251 mm.



**191200-N** ●●●●

Dosificador de jabon a pared MOON.  
Acabado: negro mate y negro brillo.  
Material: latón y cristal arenado.  
Wall mounted soap dispenser MOON.  
Finish: matte black and bright black.  
Material: brass & sandblasted glass.  
174 x 68 x 144 mm.



**191300-N** ●●●●

Escobillero a pared MOON.  
Acabado: negro mate y negro brillo.  
Material: latón y cristal arenado.  
Wall mounted toilet brush holder MOON.  
Finish: matte black and bright black.  
Material: brass & sandblasted glass.  
370 x 115 x 157 mm.

# MOON negro mate oro brillo

*matte black  
bright gold*

**Perchas  
Portarrollos  
Toalleros  
Dispensadores  
Escobilleros**

**Hangers  
Toilet roll holders  
Towel racks  
Dispensers  
Toilet brush holders**

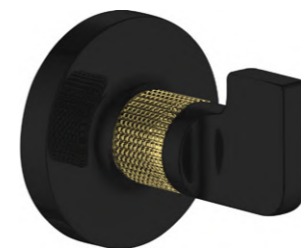

**190000-NO** ●●●●  
Percha 90° MOON.  
Acabado: negro mate y oro brillo.  
Material: latón.  
90° robe hook MOON.  
Finish: matte black and bright gold.  
Material: brass.  
62 x 60 x 68 mm.



**190100-NO** ●●●●  
Portarrollos sin tapa MOON.  
Acabado: negro mate y oro brillo.  
Material: latón.  
Toilet roll holder without lid MOON.  
Finish: matte black and bright gold.  
Material: brass.  
60 x 180 x 79 mm.



**190200-NO** ●●●●  
Portarrollos reserva MOON.  
Acabado: negro mate y oro brillo.  
Material: latón.  
Reserva toilet roll holder MOON.  
Finish: matte black and bright gold.  
Material: brass.  
182 x 60 x 92 mm.



**190300-NO** ●●●●  
Portarrollos con tapa bandeja móvil MOON.  
Acabado: negro mate y oro brillo.  
Material: latón.  
Toilet roll holder with lid tray for mobile MOON.  
Finish: matte black and bright gold.  
Material: brass.  
70 x 180 x 110 mm.



**190400-NO** ●●●●  
Toallero bidé MOON o portarrollos doble.  
Acabado: negro mate y oro brillo.  
Material: latón.  
Towel bidet MOON or double toilet roll holder.  
Finish: matte black and bright gold.  
Material: brass.  
60 x 245 x 76 mm.

Estructura de dimensiones. alto/ancho/fondo.  
Dimension structure. height/width/depth.



**190500-NO** ●●●●  
 Toallero barra 45 cm MOON.  
 Acabado: negro mate y oro brillo.  
 Material: latón.  
 Towel bar 45 cm MOON.  
 Finish: matte black and bright gold.  
 Material: brass.  
 60 x 515 x 75 mm.



**190600-NO** ●●●●  
 Toallero barra 60 cm MOON.  
 Acabado: negro mate y oro brillo.  
 Material: latón.  
 Towel bar 60 cm MOON.  
 Finish: matte black and bright gold.  
 Material: brass.  
 60 x 660 x 75 mm.



**191000-NO** ●●●●  
 Portavasos a pared MOON.  
 Acabado: negro mate y oro brillo.  
 Material: latón y cristal arenado.  
 Wall mounted tumbler holder MOON.  
 Finish: matte black and bright gold.  
 Material: brass & sandblasted glass.  
 99 x 67 x 119 mm.



**191100-NO** ●●●●  
 Jabonera a pared MOON.  
 Acabado: negro mate y oro brillo.  
 Material: latón y cristal arenado.  
 Wall mounted soap dish MOON.  
 Finish: matte black and bright gold.  
 Material: brass & sandblasted glass.  
 60 x 110 x 140 mm.

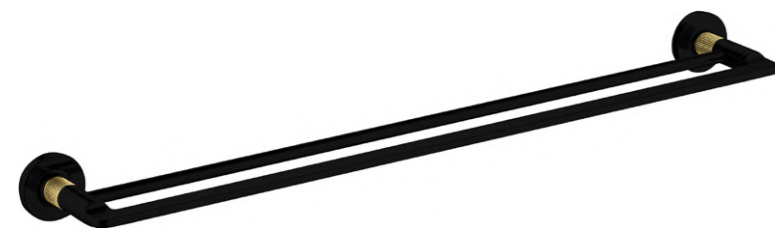

**190800-NO** ●●●●  
 Toallero doble barra 60 cm MOON.  
 Acabado: negro mate y oro brillo.  
 Material: latón.  
 Double towel bar 60 cm MOON.  
 Finish: matte black and bright gold.  
 Material: brass.  
 60 x 660 x 121 mm.

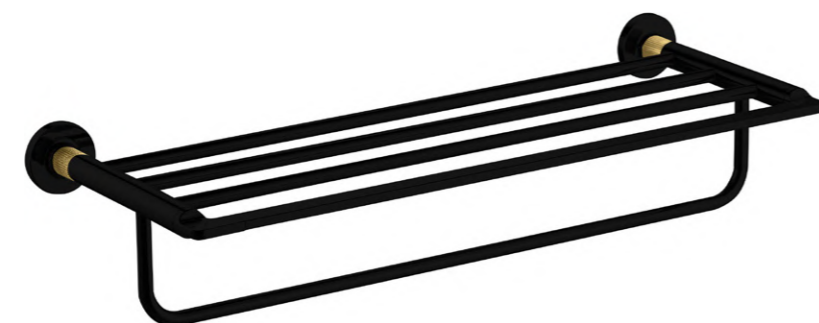

**190900-NO** ●●●●  
 Toallero repisa MOON.  
 Acabado: negro mate y oro brillo.  
 Material: latón.  
 Towel shelf MOON.  
 Finish: matte black and bright gold.  
 Material: brass.  
 119 x 660 x 251 mm.



**191200-NO** ●●●●  
 Dosificador de jabon a pared MOON.  
 Acabado: negro mate y oro brillo.  
 Material: latón y cristal arenado.  
 Wall mounted soap dispenser MOON.  
 Finish: matte black and bright gold.  
 Material: brass & sandblasted glass.  
 174 x 68 x 144 mm.



**191300-NO** ●●●●  
 Escobillero a pared MOON.  
 Acabado: negro mate y oro brillo.  
 Material: latón y cristal arenado.  
 Wall mounted toilet brush holder MOON.  
 Finish: matte black and bright gold.  
 Material: brass & sandblasted glass.  
 370 x 115 x 157 mm.

# MOON negro mate cobre brillo

*matte black  
bright cooper*

**Perchas  
Portarrollos  
Toalleros  
Dispensadores  
Escobilleros**

*Hangers  
Toilet roll holders  
Towel racks  
Dispensers  
Toilet brush holders*

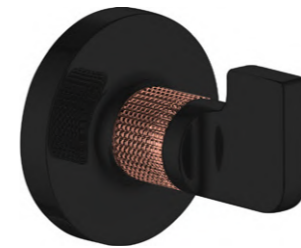

**190000-NC** ●●●●  
Percha 90° MOON.  
Acabado: negro mate y cobre brillo.  
Material: latón.  
90° robe hook MOON.  
Finish: matte black and bright copper.  
Material: brass.  
62 x 60 x 68 mm.



**190100-NC** ●●●●  
Portarrollos sin tapa MOON.  
Acabado: negro mate y cobre brillo.  
Material: latón.  
Toilet roll holder without lid MOON.  
Finish: matte black and bright copper.  
Material: brass.  
60 x 180 x 79 mm.



**190200-NC** ●●●●  
Portarrollos reserva MOON.  
Acabado: negro mate y cobre brillo.  
Material: latón.  
Reserva toilet roll holder MOON.  
Finish: matte black and bright copper.  
Material: brass.  
182 x 60 x 92 mm.



**190300-NC** ●●●●  
Portarrollos con tapa bandeja móvil MOON.  
Acabado: negro mate y cobre brillo.  
Material: latón.  
Toilet roll holder with lid tray for mobile MOON.  
Finish: matte black and bright copper.  
Material: brass.  
70 x 180 x 110 mm.



**190400-NC** ●●●●  
Toallero bidé MOON o portarrollos doble.  
Acabado: negro mate y cobre brillo.  
Material: latón.  
Towel bidet MOON or double toilet roll holder.  
Finish: matte black and bright copper.  
Material: brass.  
60 x 245 x 76 mm.

Estructura de dimensiones. alto/ancho/fondo.  
Dimension structure. height/width/depth.



**190500-NC** ●●●●  
 Toallero barra 45 cm MOON.  
 Acabado: negro mate y cobre brillo.  
 Material: latón.  
 Towel bar 45 cm MOON.  
 Finish: matte black and bright copper.  
 Material: brass.  
 60 x 515 x 75 mm.



**190600-NC** ●●●●  
 Toallero barra 60 cm MOON.  
 Acabado: negro mate y cobre brillo.  
 Material: latón.  
 Towel bar 60 cm MOON.  
 Finish: matte black and bright copper.  
 Material: brass.  
 60 x 660 x 75 mm.



**191000-NC** ●●●●  
 Portavasos a pared MOON.  
 Acabado: negro mate y cobre brillo.  
 Material: latón y cristal arenado.  
 Wall mounted tumbler holder MOON.  
 Finish: matte black and bright copper.  
 Material: brass & sandblasted glass.  
 99 x 67 x 119 mm.



**191100-NC** ●●●●  
 Jabonera a pared MOON.  
 Acabado: negro mate y cobre brillo.  
 Material: latón y cristal arenado.  
 Wall mounted soap dish MOON.  
 Finish: matte black and bright copper.  
 Material: brass & sandblasted glass.  
 60 x 110 x 140 mm.



**190800-NC** ●●●●  
 Toallero doble barra 60 cm MOON.  
 Acabado: negro mate y cobre brillo.  
 Material: latón.  
 Double towel bar 60 cm MOON.  
 Finish: matte black and bright copper.  
 Material: brass.  
 60 x 660 x 121 mm.

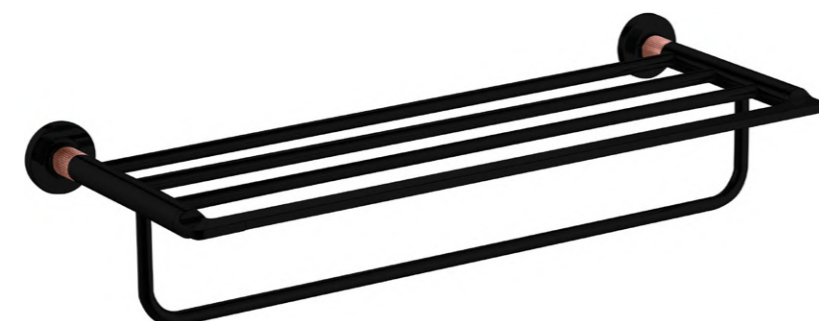

**190900-NC** ●●●●  
 Toallero repisa MOON.  
 Acabado: negro mate y cobre brillo.  
 Material: latón.  
 Towel shelf MOON.  
 Finish: matte black and bright copper.  
 Material: brass.  
 119 x 660 x 251 mm.



**191200-NC** ●●●●  
 Dosificador de jabon a pared MOON.  
 Acabado: negro mate y cobre brillo.  
 Material: latón y cristal arenado.  
 Wall mounted soap dispenser MOON.  
 Finish: matte black and bright copper.  
 Material: brass & sandblasted glass.  
 174 x 68 x 144 mm.



**191300-NC** ●●●●  
 Escobillero a pared MOON.  
 Acabado: negro mate y cobre brillo.  
 Material: latón y cristal arenado.  
 Wall mounted toilet brush holder MOON.  
 Finish: matte black and bright copper.  
 Material: brass & sandblasted glass.  
 370 x 115 x 157 mm.

KUO es una elegante serie fabricada en latón y cristal arenado con acabados en cromo brillo y negro mate que otorga un look diferente y fresco a los baños de las habitaciones.

La serie KUO mezcla líneas rectas con curvas aparentes y breves en los extremos de sus diseños. La posibilidad de combinación ofrece un ambiente único, moderno y elegante.

*KUO is an elegant series made of brass and sandblasted glass, with finishes in bright chrome and matt black that gives a different and fresh look to the bathrooms of the rooms.*

*The KUO series mixes straight lines with short curves at the ends of its designs. The possibility of combining them offers a unique, modern and elegant atmosphere.*

Los acabados especiales, cobre cepillado y latón cepillado, cuentan con un recubrimiento PVD (deposición física de vapor), que proporciona una mayor resistencia a la corrosión, asegurando una longevidad superior y manteniendo un aspecto impecable incluso con un uso intensivo.

La serie está disponible en los siguientes acabados:  
Para otros acabados, consultar con equipo comercial.

*The special finishes, brushed copper and brushed brass, feature a PVD (physical vapor deposition) coating, which provides increased corrosion resistance, ensures superior longevity and maintains a flawless appearance even with intensive use.*

*Series available in the following finishes:  
For other finishes, please contact our sales team.*

**Cromo brillo**  
*Bright chrome*



**Negro mate**  
*Matte Black*



**Latón cepillado**  
*Brushed brass*



**Cobre cepillado**  
*Brushed copper*



# KUO

# KUO

## Cromo brillo

### *bright chrome*

**Perchas**  
**Portarrollos**  
**Toalleros**  
**Jaboneras**  
**Dispensadores**  
**Escobilleros**

**Hangers**  
**Toilet roll holders**  
**Towel racks**  
**Shower baskets**  
**Dispensers**  
**Toilet brush holders**

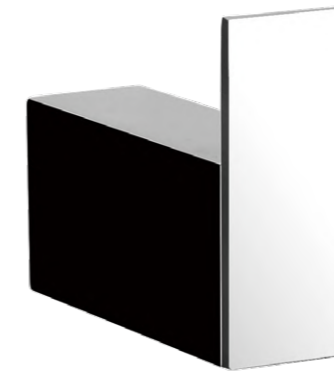

**160001** ●●●●●  
Percha baño 90° KUO.  
Acabado: cromo brillo.  
Material: latón.  
90° robe hook KUO.  
Finish: bright chrome.  
Material: brass.  
50 x 20 x 53 mm.



**160002** ●●●●●  
Percha doble KUO.  
Acabado: cromo brillo.  
Material: latón.  
Double robe hook KUO.  
Finish: bright chrome.  
Material: brass.  
30 x 70 x 53 mm.



**160201** ●●●●●  
Portarrollos sin tapa KUO.  
Acabado: cromo brillo.  
Material: latón.  
Toilet roll holder without lid KUO.  
Finish: bright chrome.  
Material: brass.  
28 x 168 x 74 mm.

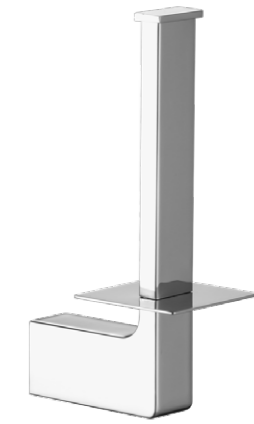

**160101** ●●●●●  
Portarrollos reserva KUO.  
Acabado: cromo brillo.  
Material: latón.  
Reserva toilet roll holder KUO.  
Finish: bright chrome.  
Material: brass.  
169 x 55 x 94 mm.



**160202** ●●●●●  
Portarrollos con tapa bandeja móvil KUO.  
Acabado: cromo brillo.  
Material: latón.  
Toilet roll holder with lid for mobile KUO.  
Finish: bright chrome.  
Material: brass.  
70 x 180 x 110 mm.



**051501** ●●●●●  
Portarrollos sin base con tapa.  
Acabado: cromo brillo.  
Material: latón.  
Toilet roll holder without base with lid.  
Finish: bright chrome.  
Material: brass.  
66 x 137 x 91 mm.

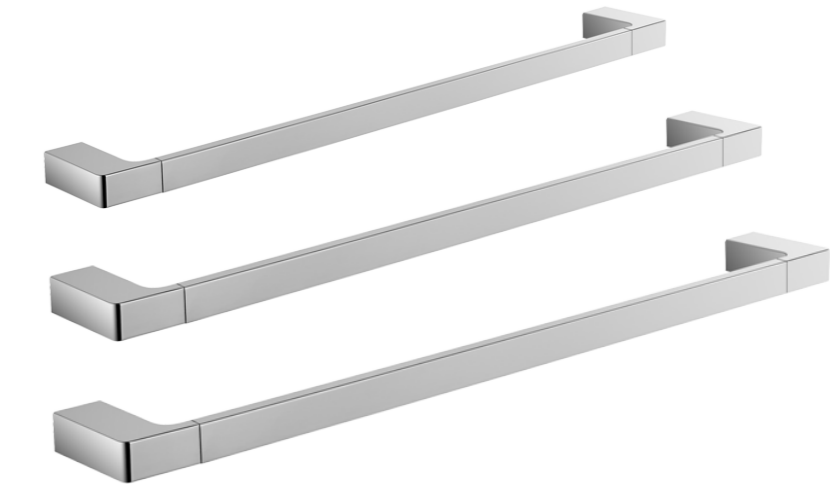

**160301** ●●●●●  
Toallero barra KUO 30 cm. Acabado: cromo brillo. Material: latón.  
Towel bar KUO 30 cm. Finish: bright chrome. Material: brass.  
24 x 305 x 72 mm.

**160701** ●●●●●  
Toallero barra KUO 40 cm. Acabado: cromo brillo. Material: latón.  
Towel bar KUO 40 cm. Finish: bright chrome. Material: brass.  
24 x 400 x 72 mm.

**160601** ●●●●●  
Toallero barra KUO 50 cm. Acabado: cromo brillo. Material: latón.  
Towel bar KUO 50 cm. Finish: bright chrome. Material: brass.  
24 x 500 x 72 mm.

Estructura de dimensiones. alto/ancho/fondo.  
Dimension structure. height/width/depth.

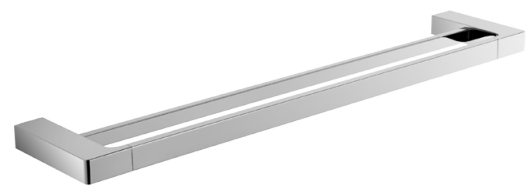

**160401** ●●●●●  
Toallero barra doble KUO 60 cm.  
Acabado: cromo brillo.  
Material: latón.  
Double towel bar KUO 60 cm.  
Finish: bright chrome.  
Material: brass.  
24 x 600 x 120 mm.



**160501** ●●●●●  
Toallero repisa con barra KUO 60 cm.  
Acabado: cromo brillo.  
Material: latón.  
Towel shelf with bar KUO 60 cm.  
Finish: bright chrome.  
Material: brass.  
125 x 600 x 220 mm.



**160801** ●●●●●  
Dosificador de jabón a pared KUO.  
Acabado: cromo brillo.  
Material: latón y cristal arenado.  
Wall mounted soap dispenser KUO.  
Finish: bright chrome.  
Material: brass & sandblasted glass.  
175 x 78 x 112 mm.



**161100** ●●●●●  
Escobillero a pared KUO.  
Acabado: cromo brillo.  
Material: latón y cristal arenado.  
Wall mounted toilet brush holder.  
Finish: bright chrome.  
Material: brass & sandblasted glass.  
383 x 105 x 118 mm.



**066001** ●●●●●  
Escobillero a pared redondo TOP ONE.  
Acabado: cromo brillo.  
Material: acero inoxidable.  
Wall mounted round toilet brush holder TOP ONE.  
Finish: bright chrome.  
Material: stainless steel.  
420 x 82 x 94 mm.



**065001** ●●●●●  
Escobillero a pared cuadrado TOP ONE.  
Acabado: cromo brillo.  
Material: acero inoxidable.  
Wall mounted square toilet brush holder TOP ONE.  
Finish: bright chrome.  
Material: stainless steel.  
420 x 82 x 93 mm.



**161000** ●●●●●  
Portavasos a pared KUO.  
Acabado: cromo brillo.  
Material: latón y cristal arenado.  
Wall mounted tumbler holder KUO.  
Finish: bright chrome.  
Material: brass & sandblasted glass.  
95 x 78 x 97 mm.



**160901** ●●●●●  
Jabonera a pared KUO.  
Acabado: cromo brillo.  
Material: latón y cristal arenado.  
Wall mounted soap dish KUO.  
Finish: bright chrome.  
Material: brass & sandblasted glass.  
43 x 110 x 113 mm.



**064202** ●●●  
Esponjara rincón.  
Acabado: cromo brillo.  
Material: acero inoxidable.  
Corner shower basket.  
Finish: bright chrome.  
Material: stainless steel.  
25 x 250 x 180 mm.



**064200** ●●●  
Esponjara rectangular.  
Acabado: cromo brillo.  
Material: acero inoxidable.  
Square shower basket.  
Finish: bright chrome.  
Material: stainless steel.  
50 x 200 x 115 mm.



# KUO

## negro mate

### matte black

**Perchas**  
**Portarrollos**  
**Toalleros**  
**Jaboneras**  
**Dispensadores**  
**Escobilleros**

**Hangers**  
**Toilet roll holders**  
**Towel racks**  
**Shower baskets**  
**Dispensers**  
**Toilet brush holders**

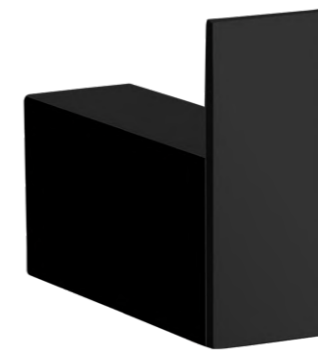

**160000-N** ●●●●  
 Percha baño 90° KUO.  
 Acabado: negro mate.  
 Material: latón.  
 90° robe hook KUO.  
 Finish: matte black.  
 Material: brass.  
 50 x 20 x 53 mm.

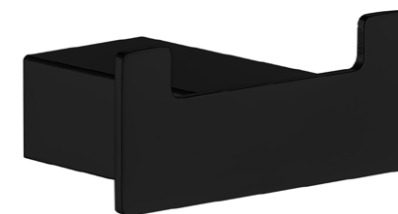

**160002-N** ●●●●  
 Percha doble KUO.  
 Acabado: negro mate.  
 Material: latón.  
 Double robe hook KUO.  
 Finish: matte black.  
 Material: brass.  
 30 x 70 x 53 mm.



**160200-N** ●●●●  
 Portarrollos sin tapa KUO.  
 Acabado: negro mate.  
 Material: latón.  
 Toilet roll holder without lid KUO.  
 Finish: matte black.  
 Material: brass.  
 28 x 168 x 74 mm.



**160100-N** ●●●●  
 Portarrollos reserva KUO.  
 Acabado: negro mate.  
 Material: latón.  
 Reserva toilet roll holder KUO.  
 Finish: matte black.  
 Material: brass.  
 169 x 55 x 94 mm.



**160202-N** ●●●●  
 Portarrollos con tapa bandeja móvil KUO.  
 Acabado: negro mate.  
 Material: latón.  
 Toilet roll holder with lid for mobile KUO.  
 Finish: matte black.  
 Material: brass.  
 70 x 180 x 110 mm.



**051501-N** ●●●●  
 Portarrollos sin base con tapa.  
 Acabado: negro mate.  
 Material: latón.  
 Toilet roll holder without base with lid.  
 Finish: matte black.  
 Material: brass.  
 66 x 137 x 91

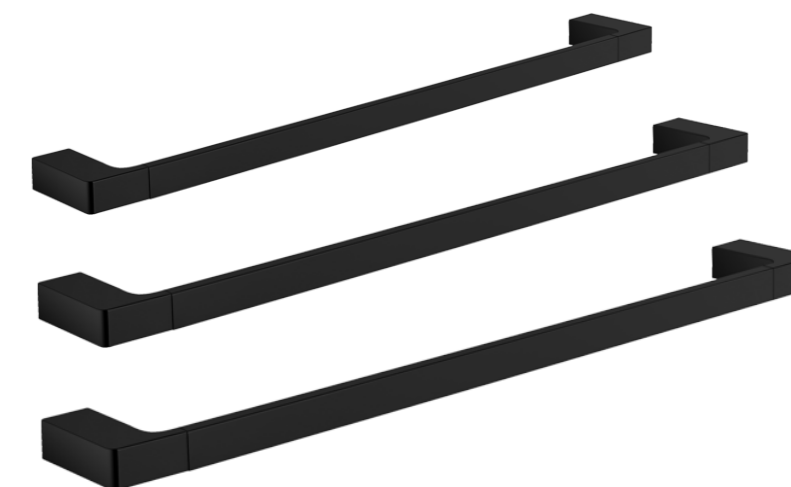

**160300-N** ●●●●  
 Toallero barra KUO 30 cm. Acabado: negro mate. Material: latón.  
 Towel bar KUO 30 cm. Finish: matte black. Material: brass.  
 24 x 305 x 72 mm.

**160700-N** ●●●●  
 Toallero barra KUO 40 cm. Acabado: negro mate. Material: latón.  
 Towel bar KUO 40 cm. Finish: matte black. Material: brass.  
 24 x 400 x 72 mm.

**160600-N** ●●●●  
 Toallero barra KUO 50 cm. Acabado: negro mate. Material: latón.  
 Towel bar KUO 50 cm. Finish: matte black. Material: brass.  
 24 x 500 x 72 mm.

Estructura de dimensiones. alto/ancho/fondo.  
 Dimension structure. height/width/depth.

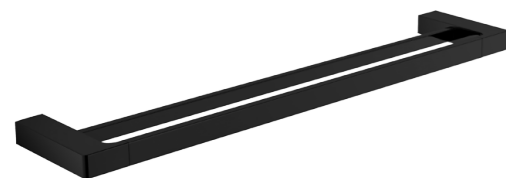

**160400-N** ● ● ● ● ●  
 Toallero barra doble KUO 60 cm.  
 Acabado: negro mate.  
 Material: latón  
 Double towel bar KUO 60 cm.  
 Finish: matte black.  
 Material: brass.  
 24 x 600 x 120 mm.



**160500-N** ● ● ● ● ●  
 Toallero repisa con barra KUO 60 cm.  
 Acabado: negro mate.  
 Material: latón  
 Towel shelf with bar KUO 60 cm.  
 Finish: matte black.  
 Material: brass.  
 125 x 600 x 220 mm.



**160800-N** ● ● ● ● ●  
 Dosificador de jabón a pared KUO.  
 Acabado: negro mate.  
 Material: latón y cristal arenado.  
 Wall mounted soap dispenser KUO.  
 Finish: matte black.  
 Material: brass & sandblasted glass.  
 175 x 78 x 112 mm.



**161100-N** ● ● ● ● ●  
 Escobillero a pared KUO.  
 Acabado: negro mate.  
 Material: latón y cristal arenado.  
 Wall mounted toilet brush holder.  
 Finish: matte black.  
 Material: brass & sandblasted glass.  
 383 x 105 x 118 mm.



**066001-N** ● ● ● ● ●  
 Escobillero a pared redondo TOP ONE.  
 Acabado: negro mate.  
 Material: acero inoxidable.  
 Wall mounted round toilet brush holder  
 TOP ONE.  
 Finish: matte black.  
 Material: stainless steel.  
 420 x 82 x 94 mm.



**065001-N** ● ● ● ● ●  
 Escobillero a pared cuadrado TOP ONE.  
 Acabado: negro mate.  
 Material: acero inoxidable.  
 Wall mounted square toilet brush holder  
 TOP ONE.  
 Finish: matte black.  
 Material: stainless steel.  
 420 x 82 x 93 mm.



**161000-N** ● ● ● ● ●  
 Portavasos a pared KUO.  
 Acabado: negro mate.  
 Material: latón y cristal arenado.  
 Wall mounted tumbler holder  
 KUO.  
 Finish: matte black.  
 Material: brass & sandblasted  
 glass.  
 95 x 78 x 97 mm.



**160900-N** ● ● ● ● ●  
 Jabonera a pared KUO.  
 Acabado: negro mate.  
 Material: latón y cristal arenado.  
 Wall mounted soap dish KUO.  
 Finish: matte black.  
 Material: brass & sandblasted  
 glass.  
 43 x 110 x 113 mm.

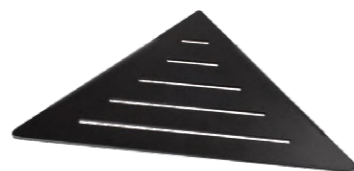

**064202-N** ● ● ● ● ●  
 Esponjara rincón.  
 Acabado: negro mate.  
 Material: acero inoxidable.  
 Corner shower basket black matt.  
 Finish: matte black.  
 Material: stainless steel.  
 25 x 250 x 180 mm.



**064200-N** ● ● ● ● ●  
 Esponjara rectangular.  
 Acabado: negro mate.  
 Material: acero inoxidable.  
 Square shower basket black matt.  
 Finish: matte black.  
 Material: stainless steel.  
 50 x 200 x 115 mm.



# KUO ADHESIVO cromo brillo

*bright Chrome*

**Perchas  
Portarrollos  
Toalleros**

**Hangers  
Toilet roll holders  
Towel racks**



**161501** ● ●  
Percha baño 90° KUO ADHESIVO.  
Acabado: cromo brillo.  
Material: latón.  
90° robe hook KUO ADHESIVE.  
Finish: bright chrome.  
Material: brass.  
60 x 40 x 60 mm.



**161701** ● ●  
Portarrollos sin tapa KUO ADHESIVO.  
Acabado: cromo brillo.  
Material: latón.  
Toilet roll holder without lid KUO ADHESIVE.  
Finish: bright chrome.  
Material: brass.  
40 x 190 x 80 mm.



**161801** ● ●  
Portarrollos reserva KUO ADHESIVO.  
Acabado: cromo brillo.  
Material: latón.  
Reserva toilet roll holder KUO ADHESIVE.  
Finish: bright chrome.  
Material: brass.  
190 x 55 x 100 mm.



**161201** ● ●  
Toallero barra 30 cm KUO ADHESIVO.  
Acabado: cromo brillo.  
Material: latón.  
Towel bar KUO ADHESIVE 30 cm.  
Finish: bright chrome.  
Material: brass.  
43 x 318 x 74 mm.

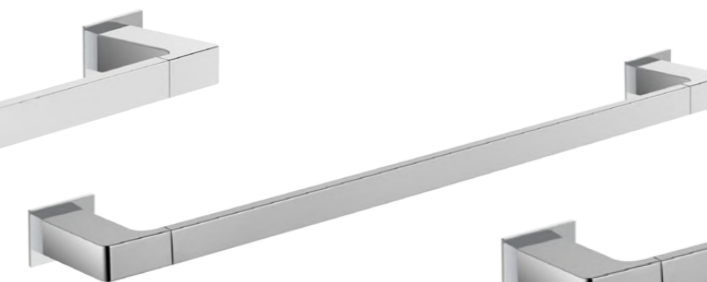

**161301** ● ●  
Toallero barra 40 cm KUO ADHESIVO.  
Acabado: cromo brillo.  
Material: latón.  
Towel bar KUO ADHESIVE 40 cm.  
Finish: bright chrome.  
Material: brass.  
43 x 418 x 74 mm.

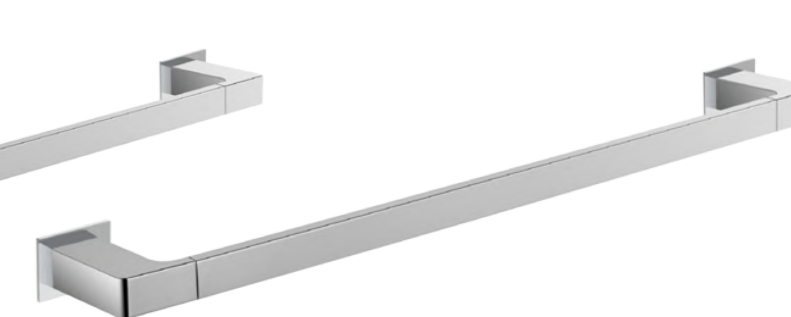

**161401** ● ●  
Toallero barra 50 cm KUO ADHESIVO.  
Acabado: cromo brillo.  
Material: latón.  
Towel bar KUO ADHESIVE 50 cm.  
Finish: bright chrome.  
Material: brass.  
43 x 518 x 74 mm.

Estructura de dimensiones. alto/ancho/fondo.  
Dimension structure. height/width/depth.

# KUO ADHESIVO negro mate

*matte black*

**Perchas  
Portarrollos  
Toalleros**

**Hangers  
Toilet roll holders  
Towel racks**



**161501-N** ● ●  
Percha baño 90° KUO ADHESIVO.  
Acabado: negro mate.  
Material: latón.  
90° robe hook KUO ADHESIVE.  
Finish: matte black.  
Material: brass.  
60 x 40 x 60 mm.



**161701-N** ● ●  
Portarrollos sin tapa KUO ADHESIVO.  
Acabado: negro mate.  
Material: latón.  
Toilet roll holder without lid KUO ADHESIVE.  
Finish: matte black.  
Material: brass.  
40 x 190 x 80 mm.



**161801-N** ● ●  
Portarrollos reserva KUO ADHESIVO.  
Acabado: negro mate.  
Material: latón.  
Reserva toilet roll holder KUO ADHESIVE.  
Finish: matte black.  
Material: brass.  
190 x 55 x 100 mm.

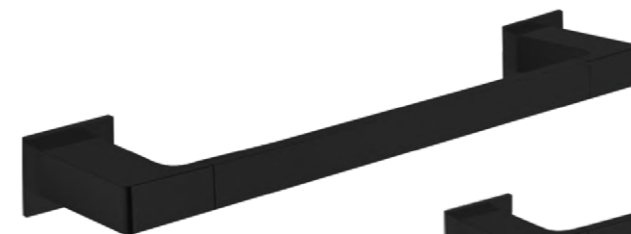

**161201-N** ● ●  
Toallero barra 30 cm KUO ADHESIVO.  
Acabado: negro mate.  
Material: latón.  
Towel bar KUO ADHESIVE 30 cm.  
Finish: matte black.  
Material: brass.  
43 x 318 x 74 mm.

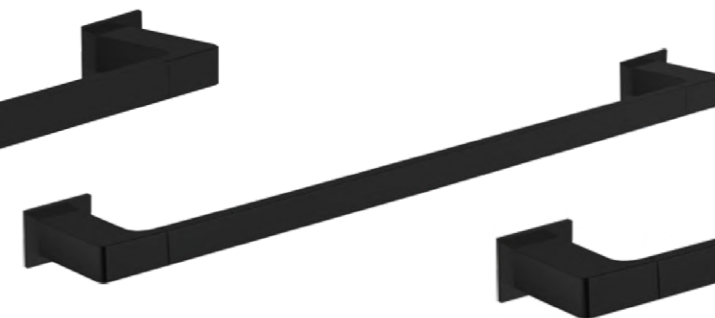

**161301-N** ● ●  
Toallero barra 40 cm KUO ADHESIVO.  
Acabado: negro mate.  
Material: latón.  
Towel bar KUO ADHESIVE 40 cm.  
Finish: matte black.  
Material: brass.  
43 x 418 x 74 mm.



**161401-N** ● ●  
Toallero barra 50 cm KUO ADHESIVO.  
Acabado: negro mate.  
Material: latón.  
Towel bar KUO ADHESIVE 50 cm.  
Finish: matte black.  
Material: brass.  
43 x 518 x 74 mm.

Estructura de dimensiones. alto/ancho/fondo.  
Dimension structure. height/width/depth.

# METRO

METRO es una serie de accesorios de baño fabricada en latón que presenta un diseño sencillo y moderno. Ofrece una combinación perfecta entre funcionalidad y estética contemporánea.

Cada pieza de la serie está pensada para integrarse de manera armónica en cualquier baño y su estilo depurado contribuye a crear espacios que transmiten serenidad y equilibrio visual.

Una serie disponible en varios acabados que permite adaptarse a diferentes tendencias y estilos de diseño, desde los baños más vanguardistas hasta los más clásicos, sin perder su carácter moderno.

*METRO is a series of bathroom accessories made of brass with a simple, modern design. It offers a perfect combination of functionality and contemporary aesthetics.*

*Each piece in the series is designed to blend harmoniously into any bathroom and its refined style helps to create spaces that convey serenity and visual balance.*

*A series available in several finishes that allows it to adapt to different design trends and styles, from the most avant-garde to the most classic bathrooms, without losing its modern character.*

Los acabados especiales, cobre cepillado y latón cepillado, cuentan con un recubrimiento PVD (deposición física de vapor), que proporciona una mayor resistencia a la corrosión, asegurando una longevidad superior y manteniendo un aspecto impecable incluso con un uso intensivo.

La serie está disponible en los siguientes acabados:  
Para otros acabados, consultar con equipo comercial.

*The special finishes, brushed copper and brushed brass, feature a PVD (physical vapor deposition) coating, which provides increased corrosion resistance, ensures superior longevity and maintains a flawless appearance even with intensive use.*

*Series available in the following finishes:  
For other finishes, please contact our sales team.*

**Cromo brillo**  
Bright chrome



**Negro mate**  
Matte Black



**Blanco mate**  
Matte white



**Latón cepillado**  
Brushed brass



**Cobre cepillado**  
Brushed copper



# METRO

## Cromo brillo

*bright chrome*

**Perchas**  
**Portarrollos**  
**Toalleros**  
**Esponjeras**  
**Escobilleros**

**Hangers**  
**Toilet roll holders**  
**Towel racks**  
**Shower baskets**  
**Toilet brush holders**



**150100** ● ● ○ ● ●  
 Percha baño 90° METRO.  
 Acabado: cromo brillo.  
 Material: latón.  
 90° Robe hook METRO.  
 Finish: bright chrome.  
 Material: brass.  
 45 x 45 x 60 mm.



**150200** ● ● ○ ● ●  
 Percha recta sin base.  
 Acabado: cromo brillo.  
 Material: latón.  
 Robe hook without base.  
 Finish: bright chrome.  
 Material: brass.  
 30 x 30 x 40 mm.

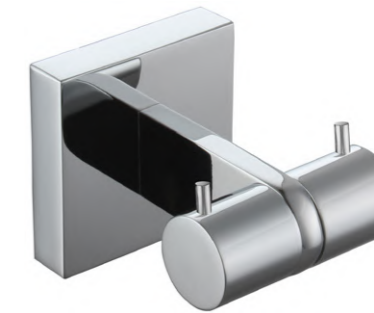

**151400** ● ● ○ ● ●  
 Percha doble METRO.  
 Acabado: cromo brillo.  
 Material: latón.  
 Double hook METRO.  
 Finish: bright chrome.  
 Material: brass.  
 45 x 45 x 60 mm.



**508400** ● ● ○ ● ●  
 Portarrollos cuadrado con tapa.  
 Acabado: cromo brillo.  
 Material: acero inoxidable.  
 Toilet roll holder with lid.  
 Finish: bright chrome.  
 Material: stainless steel.  
 80 x 130 x 130 mm.



**150900** ● ● ○ ● ●  
 Portarrollos con tapa METRO.  
 Acabado: cromo brillo.  
 Material: latón.  
 Toilet roll holder with lid METRO.  
 Finish: bright chrome.  
 Material: brass.  
 137 x 136 x 63 mm.



**151000** ● ● ○ ● ●  
 Portarrollos sin tapa METRO.  
 Acabado: cromo brillo.  
 Material: latón.  
 Toilet roll holder without lid METRO.  
 Finish: bright chrome.  
 Material: brass.  
 45 x 143 x 80 mm.



**151100** ● ● ○ ● ●  
 Portarrollos reserva METRO.  
 Acabado: cromo brillo.  
 Material: latón.  
 Toilet roll holder METRO.  
 Finish: bright chrome.  
 Material: brass.  
 143 x 45 x 75 mm.

Estructura de dimensiones. alto/ancho/fondo.  
 Dimension structure. height/width/depth.



**150400** ● ○ ● ● ●  
 Toallero anilla pequeña METRO.  
 Acabado: cromo brillo.  
 Material: latón.  
 Small towel ring METRO.  
 Finish: bright chrome.  
 Material: brass.  
 99 x 144 x 60 mm.

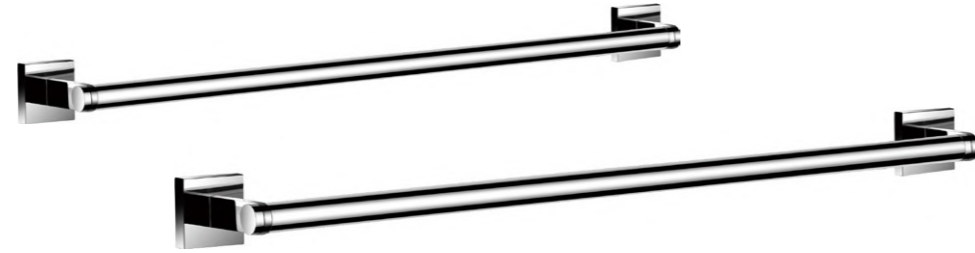

**150700** ● ○ ● ● ●  
 Toallero barra METRO 45 cm.  
 Acabado: cromo brillo.  
 Material: latón.  
 Towel bar METRO 45 cm.  
 Finish: bright chrome.  
 Material: brass.  
 45 x 501 x 75 mm.

**150800** ● ○ ● ● ●  
 Toallero barra METRO 60 cm.  
 Acabado: cromo brillo.  
 Material: latón.  
 Towel bar METRO 60 cm.  
 Finish: bright chrome.  
 Material: brass.  
 45 x 646 x 75 mm.

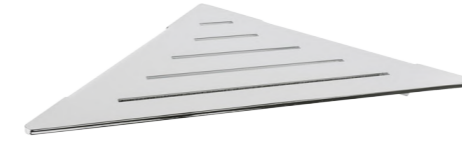

**064202** ● ● ○  
 Esponjera rincón.  
 Acabado: cromo brillo.  
 Material: acero inoxidable.  
 Corner shower basket.  
 Finish: bright chrome.  
 Material: stainless steel.  
 25 x 250 x 180 mm.



**064200** ● ● ○  
 Esponjera rectangular.  
 Acabado: cromo brillo.  
 Material: acero inoxidable.  
 Square shower basket.  
 Finish: bright chrome.  
 Material: stainless steel.  
 50 x 200 x 115 mm.



**064201** ● ● ○ ● ●  
 Esponjera rectangular hybrid METRO.  
 Acabado: cromo brillo.  
 Material: acero inoxidable.  
 Square hybrid shower basket METRO.  
 Finish: bright chrome.  
 Material: stainless steel.  
 61 x 200 x 110 mm.



**151300** ● ● ○ ● ●  
 Toallero repisa con barra METRO 60 cm.  
 Acabado: cromo brillo.  
 Material: latón.  
 Towel shelf with bar 60 cm METRO.  
 Finish: bright chrome.  
 Material: brass.  
 143 x 645 x 247 mm.

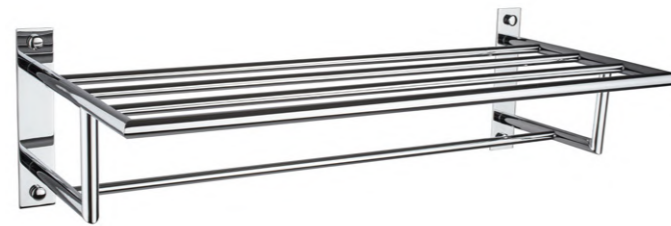

**151200** ● ● ○ ● ●  
 Toallero repisa con barra cuatro anclajes METRO 50 cm.  
 Acabado: cromo brillo.  
 Material: latón.  
 Towel shelf with bar four anchors 50 cm METRO.  
 Finish: bright chrome.  
 Material: brass.  
 150 x 530 x 228 mm.



**064204-INT-N** ● ● ○ ● ●  
 Esponjera rincón interior negro.  
 Acabado: cromo brillo.  
 Material: acero inoxidable y ABS.  
 Corner shower basket with black interior.  
 Finish: bright chrome.  
 Material: stainless steel and ABS.  
 52 x 220 x 220 mm.



**064205** ● ● ○ ● ●  
 Esponjera rectangular interior negro.  
 Acabado: cromo brillo.  
 Material: acero inoxidable y ABS.  
 Square shower basket with black interior.  
 Finish: bright chrome.  
 Material: stainless steel and ABS.  
 53 x 300 x 124 mm.



**062000** ● ● ○ ● ●  
Escobillero pared/suelo redondo.  
Acabado: cromo brillo.  
Material: acero inoxidable.  
Round toilet brush holder wall/floor.  
Finish: bright chrome.  
Material: stainless steel.  
380 x 96 x 92 mm.



**022500** ● ● ○ ● ●  
Escobillero pared/suelo cuadrado.  
Acabado: cromo brillo.  
Material: acero inoxidable.  
Square toilet brush holder wall/floor.  
Finish: bright chrome.  
Material: stainless steel.  
386 x 82 x 82 mm.



**067001** ● ● ○ ● ●  
Escobillero suelo cuadrado TOP ONE.  
Acabado: cromo brillo.  
Material: acero inoxidable.  
Square toilet brush holder floor TOP ONE.  
Finish: bright chrome.  
Material: stainless steel.  
420 x 82 x 82 mm.



# CUBIK

CUBIK es una moderna serie fabricada en latón con tubo redondo acabado en inglete que da un aspecto siempre actual. Ofrece versatilidad y múltiples combinaciones en espacios de baño, siendo altamente combinable con diversos estilos de diseño de interiores. Esta serie está disponible en los siguientes acabados:

- **cromo brillo**
- **negro mate**
- **cobre cepillado**
- **latón cepillado**

*CUBIK is a modern series made of brass with a round, mitre-finished tube for a contemporary look. It offers versatility and multiple combinations in bathroom spaces, being highly combinable with various interior design styles. This series is available in the following finishes:*

- ***bright chrome***
- ***matte black***
- ***brushed copper***
- ***brushed brass***

Los acabados especiales, cobre cepillado y latón cepillado, cuentan con un recubrimiento PVD (deposición física de vapor), que proporciona una mayor resistencia a la corrosión, asegurando una longevidad superior y manteniendo un aspecto impecable incluso con un uso intensivo.

La serie está disponible en los siguientes acabados:  
Para otros acabados, consultar con equipo comercial.

*The special finishes, brushed copper and brushed brass, feature a PVD (physical vapor deposition) coating, which provides increased corrosion resistance, ensures superior longevity and maintains a flawless appearance even with intensive use.*

*Series available in the following finishes:  
For other finishes, please contact our sales team.*

**Cromo brillo**  
*Bright chrome*



**Negro mate**  
*Matte Black*



**Latón cepillado**  
*Brushed brass*



**Cobre cepillado**  
*Brushed copper*



# CUBIK

## chromo brillo

*bright chrome*

**Perchas**  
**Portarrollos**  
**Toalleros**  
**Asas**  
**Esponjeras**  
**Escobilleros**  
**Espejos Aumento**

**Hangers**  
**Toilet roll holders**  
**Towel racks**  
**Grab rails**  
**Shower baskets**  
**Toilet brush holders**  
**Magnifying mirror**



**050100** ●●●●●  
 Percha 90° CUBIK.  
 Acabado: cromo brillo.  
 Material: latón.  
 90° robe hook CUBIK.  
 Finish: bright chrome.  
 Material: brass.  
 58 x 52 x 69 mm.

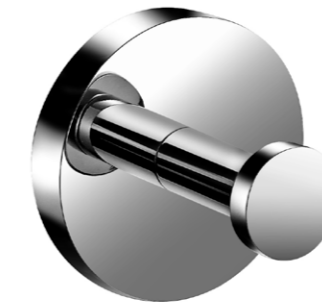

**060201** ●●●●●  
 Percha recta short.  
 Acabado: cromo brillo.  
 Material: latón.  
 Short robe hook.  
 Finish: bright chrome.  
 Material: brass.  
 52 x 52 x 44 mm.



**150200** ●●●●●  
 Percha recta sin base.  
 Acabado: cromo brillo.  
 Material: latón.  
 Robe hook without base.  
 Finish: bright chrome.  
 Material: brass.  
 30 x 30 x 40 mm.



**060301** ●●●●●  
 Percha doble.  
 Acabado: cromo brillo.  
 Material: latón.  
 Double robe hook.  
 Finish: bright chrome.  
 Material: brass.  
 59 x 71 x 51 mm.



**508400** ●●●●●  
 Portarrollos cuadrado con tapa.  
 Acabado: cromo brillo.  
 Material: acero inoxidable.  
 Square toilet roll holder with lid.  
 Finish: bright chrome.  
 Material: stainless steel.  
 80 x 130 x 130 mm.



**051500** ●●●●●  
 Portarrollos con tapa elevable CUBIK.  
 Acabado: cromo brillo.  
 Material: latón.  
 Toilet roll holder with lid CUBIK.  
 Finish: bright chrome.  
 Material: brass.  
 65 x 130 x 120 mm.



**051501** ●●●●●  
 Portarrollos sin base con tapa.  
 Acabado: cromo brillo.  
 Material: latón.  
 Toilet roll holder without base with lid.  
 Finish: bright chrome.  
 Material: brass.  
 66 x 137 x 91 mm.



**070500** ●●●●●  
 Portarrollos con tapa.  
 Acabado: cromo brillo.  
 Material: latón.  
 Toilet roll holder with lid.  
 Finish: bright chrome.  
 Material: brass.  
 160 x 140 x 54 mm.

Estructura de dimensiones. alto/ancho/fondo.  
 Dimension structure. height/width/depth.



**051000** ●●●●●  
 Portarrollos sin tapa CUBIK.  
 Acabado: cromo brillo.  
 Material: latón.  
 Toilet roll holder without lid CUBIK.  
 Finish: bright chrome.  
 Material: brass.  
 52 x 158 x 91 mm.



**051100** ●●●●●  
 Portarrollos reserva CUBIK.  
 Acabado: cromo brillo.  
 Material: latón.  
 Reserva toilet roll holder CUBIK.  
 Finish: bright chrome.  
 Material: brass.  
 176 x 53 x 87 mm.

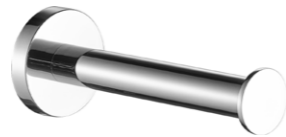

**022100** ●●●●●  
 Portarrollos recto horizontal.  
 Acabado: cromo brillo.  
 Material: acero inoxidable.  
 Horizontal toilet roll holder.  
 Finish: bright chrome.  
 Material: stainless steel.  
 46 x 46 x 160 mm.



**151001** ●●●●●  
 Portarrollos eje elevable CUBIK.  
 Acabado: cromo brillo.  
 Material: latón.  
 Toilet roll holder with lift-up axis.  
 Finish: bright chrome.  
 Material: brass.  
 52 x 193 x 82 mm.



**050600** ●●●●●  
 Toallero barra CUBIK 30 cm.  
 Acabado: cromo brillo. Material: latón.  
 Towel bar CUBIK 30 cm.  
 Finish: bright chrome. Material: brass.  
 52 x 333 x 70 mm.



**050700** ●●●●●  
 Toallero barra CUBIK 45 cm.  
 Acabado: cromo brillo. Material: latón.  
 Towel bar CUBIK 45 cm.  
 Finish: bright chrome. Material: brass.  
 52 x 463 x 70 mm.



**050800** ●●●●●  
 Toallero barra CUBIK 60 cm.  
 Acabado: cromo brillo. Material: latón.  
 Towel bar CUBIK 60 cm.  
 Finish: bright chrome. Material: brass.  
 52 x 613 x 70 mm.



**051400** ●●●●●  
 Portarrollos doble CUBIK.  
 Acabado: cromo brillo.  
 Material: latón.  
 Double toilet roll holder CUBIK.  
 Finish: bright chrome.  
 Material: brass.  
 52 x 267 x 94 mm.



**050400** ●●●●●  
 Tollerero anilla pequeña CUBIK.  
 Acabado: cromo brillo.  
 Material: latón.  
 Small towel ring CUBIK.  
 Finish: bright chrome.  
 Material: brass.  
 110 x 150 x 70 mm.



**050500** ●●●●●  
 Toallero anilla grande CUBIK.  
 Acabado: cromo brillo.  
 Material: latón.  
 Big towel ring CUBIK.  
 Finish: bright chrome.  
 Material: brass.  
 180 x 225 x 70 mm.



**052200** ●●●●●  
 Toallero barra doble CUBIK.  
 Acabado: cromo brillo. Material: latón.  
 Double towel bar CUBIK.  
 Finish: bright chrome. Material: brass.  
 52 x 613 x 118 mm.

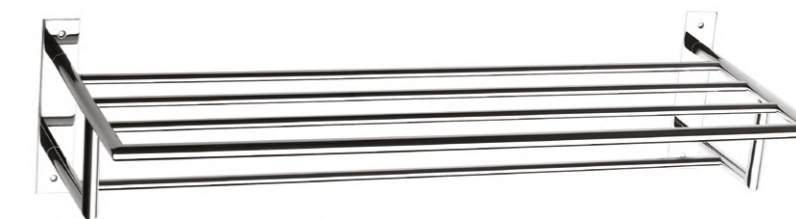

**151200** ●●  
 Toallero repisa con barra 4 anclajes 50 cm.  
 Acabado: cromo brillo. Material: latón.  
 Towel shelf with bar and 4 anchors 50 cm.  
 Finish: bright chrome. Material: brass.  
 150 x 530 x 228 mm.

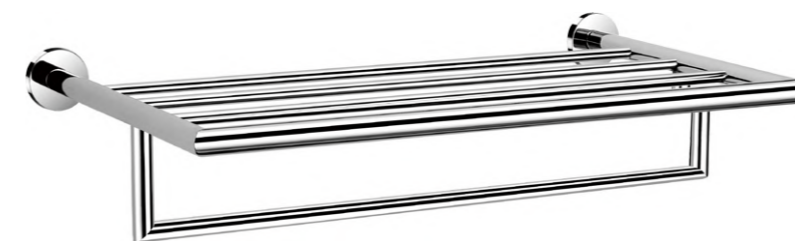

**061311** ●●  
 Toallero repisa con barra 50 cm.  
 Acabado: cromo brillo. Material: latón.  
 Towel shelf with bar 50 cm.  
 Finish: bright chrome. Material: brass.  
 134 x 552 x 270 mm.

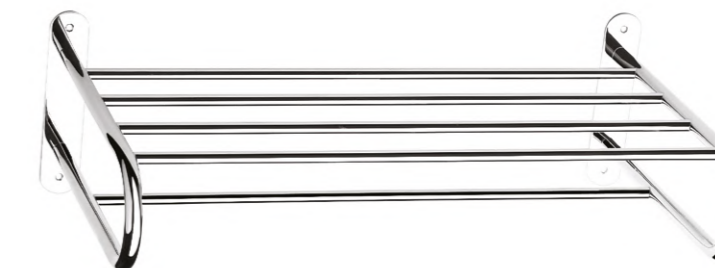

**061500** ●●  
 Toallero repisa pletinas con barra 4 anclajes 50 cm.  
 Acabado: cromo brillo. Material: latón.  
 Towel shelf with bar and 4 anchors 50 cm.  
 Finish: bright chrome. Material: brass.  
 145 x 480 x 260 mm.



**061700** ●●●  
Asa recta 30 cm.  
Acabado: cromo brillo.  
Material: latón.  
Grab rail 30 cm.  
Finish: bright chrome.  
Material: brass.  
50 x 330 x 74 mm.



**061800** ●●●  
Asa bañera curva.  
Acabado: cromo brillo.  
Material: latón.  
Angled grab rail.  
Finish: bright chrome.  
Material: brass.  
125 x 425 x 70 mm.



**061900** ●●●  
Asa bañera curva con jabonera.  
Acabado: cromo brillo.  
Material: latón.  
Angled grab rail with soap rack.  
Finish: bright chrome.  
Material: brass.  
200 x 430 x 120 mm.



**502110** ●●●●●  
Dosificador pared 250 ml.  
Acabado: cromo brillo.  
Material: latón.  
Soap dispenser 250 ml.  
Finish: bright chrome.  
Material: brass.  
210 x 60 x 90 mm.



**064001** ●●●●●  
Esponjera rejilla rincón.  
Acabado: cromo brillo.  
Material: latón.  
Corner shower basket grid.  
Finish: bright chrome.  
Material: brass.  
63 x 195 x 195 mm.



**064100** ●●●●●  
Esponjera rejilla rectangular.  
Acabado: cromo brillo.  
Material: latón.  
Square shower basket grid.  
Finish: bright chrome.  
Material: brass.  
48 x 250 x 123 mm.



**065101** ●●●●●  
Esponjera rejilla rectangular pequeña.  
Acabado: cromo brillo.  
Material: latón.  
Small square shower basket grid.  
Finish: bright chrome.  
Material: brass.  
35 x 132 x 95 mm.



**064202** ●●●●●  
Esponjera rincón.  
Acabado: cromo brillo.  
Material: acero inoxidable.  
Corner shower basket.  
Finish: bright chrome.  
Material: stainless steel.  
25 x 250 x 180 mm.



**064200** ●●●●●  
Esponjera rectangular.  
Acabado: cromo brillo.  
Material: acero inoxidable.  
Square shower basket.  
Finish: bright chrome.  
Material: stainless steel.  
50 x 200 x 115 mm.



**064204-INT-N** ●●●●●  
Esponjera rincón interior negro.  
Acabado: cromo brillo.  
Material: acero inoxidable y ABS.  
Corner shower basket with black interior.  
Finish: bright chrome.  
Material: stainless steel and ABS.  
52 x 220 x 220 mm.



**064205** ●●●●●  
Esponjera rectangular interior negro.  
Acabado: cromo brillo.  
Material: acero inoxidable y ABS.  
Square shower basket with black interior.  
Finish: bright chrome.  
Material: stainless steel and ABS.  
53 x 300 x 124 mm.



**062000** ●●●●●  
Escobillero pared/suelo redondo.  
Acabado: cromo brillo.  
Material: acero inoxidable.  
Round toilet brush holder wall/floor.  
Finish: bright chrome.  
Material: stainless steel.  
380 x 96 x 92 mm.



**062000-SIL** ●●●●●  
Escobillero pared/suelo tapa silicona.  
Acabado: cromo brillo.  
Material: acero inoxidable.  
Wall/floor toilet brush holder.  
Finish: bright chrome.  
Material: stainless steel.  
378 x 96 x 92 mm.



**200601-2** ●●●●●  
Espejo aumento slim joystick II  
Aumentos: x3.  
Acabado: cromo brillo.  
Magnifying mirror ECO 2 sides and 1 arm.  
Magnifications: x3.  
Finish: bright chrome.  
Ø 20 cm.

# CUBIK negro mate

*matte black*

**Perchas**  
**Portarrollos**  
**Toalleros**  
**Asas**  
**Esponjeras**  
**Escobilleros**  
**Espejos Aumento**

**Hangers**  
**Toilet roll holders**  
**Towel racks**  
**Grab rails**  
**Shower baskets**  
**Toilet brush holders**  
**Magnifying mirror**

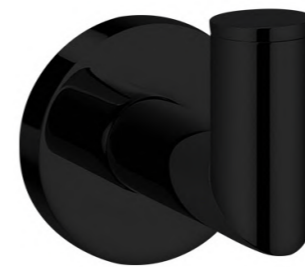

**050100-N** ●●●●  
Percha 90° CUBIK.  
Acabado: negro mate.  
Material: latón.  
90° robe hook CUBIK.  
Finish: matte black.  
Material: brass.  
58 x 52 x 69 mm.

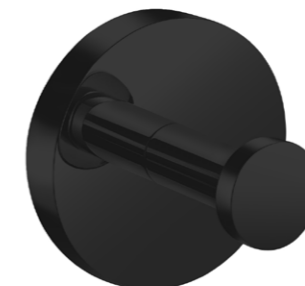

**060201-N** ●●●●  
Percha recta short.  
Acabado: negro mate.  
Material: latón.  
Short robe hook.  
Finish: matte black.  
Material: brass.  
52 x 52 x 44 mm.



**150200-N** ●●●●  
Percha recta sin base.  
Acabado: negro mate.  
Material: latón.  
Robe hook without base.  
Finish: matte black.  
Material: brass.  
30 x 30 x 40 mm.



**060301-N** ●●●●  
Percha doble.  
Acabado: negro mate.  
Material: latón.  
Double robe hook.  
Finish: matte black.  
Material: brass.  
59 x 71 x 51 mm.



**508400-N** ●●●●  
Portarrollos cuadrado con tapa.  
Acabado: negro mate.  
Material: acero inoxidable.  
Square toilet roll holder with lid.  
Finish: matte black.  
Material: stainless steel.  
80 x 130 x 130 mm.



**051501-N** ●●●●  
Portarrollos sin base con tapa.  
Acabado: negro mate.  
Material: latón.  
Toilet roll holder without base  
with lid.  
Finish: matte black.  
Material: brass.  
66 x 137 x 91 mm.



**070500-N** ●●●●  
Portarrollos con tapa.  
Acabado: negro mate.  
Material: latón.  
Toilet roll holder with lid.  
Finish: matte black.  
Material: brass.  
160 x 140 x 54 mm.

Estructura de dimensiones. alto/ancho/fondo.  
Dimension structure. height/width/depth.



**051000-N** ●●●●●  
 Portarrollos sin tapa CUBIK.  
 Acabado: negro mate.  
 Material: latón.  
 Toilet roll holder without lid CUBIK.  
 Finish: matte black.  
 Material: brass.  
 52 x 158 x 91 mm.



**051100-N** ●●●●●  
 Portarrollos reserva CUBIK.  
 Acabado: negro mate.  
 Material: latón.  
 Reserva toilet roll holder CUBIK.  
 Finish: matte black.  
 Material: brass.  
 176 x 53 x 87 mm.

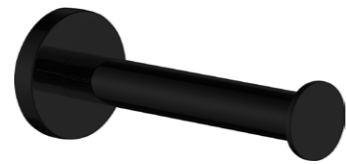

**022100-N** ●●●●●  
 Portarrollos recto horizontal.  
 Acabado: negro mate.  
 Material: acero inoxidable.  
 Horizontal toilet roll holder.  
 Finish: matte black.  
 Material: stainless steel.  
 46 x 46 x 160 mm.

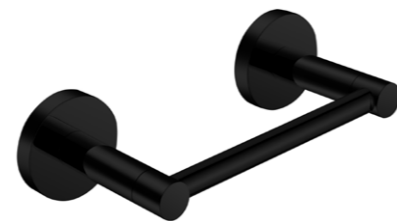

**151001-N** ●●●●●  
 Portarrollos eje elevable CUBIK.  
 Acabado: negro mate.  
 Material: latón.  
 Toilet roll holder with lift-up axis.  
 Finish: matte black.  
 Material: brass.  
 52 x 193 x 82 mm.



**051400-N** ●●●●●  
 Portarrollos doble CUBIK.  
 Acabado: negro mate.  
 Material: latón.  
 Double toilet roll holder CUBIK.  
 Finish: matte black.  
 Material: brass.  
 52 x 267 x 94 mm.



**050400-N** ●●●●●  
 Toallero anilla pequeña CUBIK.  
 Acabado: negro mate.  
 Material: latón.  
 Small towel ring CUBIK.  
 Finish: matte black.  
 Material: brass.  
 110 x 150 x 70 mm.



**050500-N** ●●●●●  
 Toallero anilla grande CUBIK.  
 Acabado: negro mate.  
 Material: latón.  
 Big towel ring CUBIK.  
 Finish: matte black.  
 Material: brass.  
 180 x 225 x 70 mm.



**050600-N** ●●●●●  
 Toallero barra CUBIK 30 cm.  
 Acabado: negro mate. Material: latón.  
 Towel bar CUBIK 30 cm.  
 Finish: matte black. Material: brass.  
 52 x 333 x 70 mm.



**050700-N** ●●●●●  
 Toallero barra CUBIK 45 cm.  
 Acabado: negro mate. Material: latón.  
 Towel bar CUBIK 45 cm.  
 Finish: matte black. Material: brass.  
 52 x 463 x 70 mm.



**050800-N** ●●●●●  
 Toallero barra CUBIK 60 cm.  
 Acabado: negro mate. Material: latón.  
 Towel bar CUBIK 60 cm.  
 Finish: matte black. Material: brass.  
 52 x 613 x 70 mm.



**052200-N** ●●●●●  
 Toallero barra doble CUBIK.  
 Acabado: negro mate. Material: latón.  
 Double towel bar CUBIK.  
 Finish: matte black. Material: brass.  
 52 x 613 x 118 mm.



**151200-N** ●●●●●  
 Toallero repisa con barra 4 anclajes 50 cm.  
 Acabado: negro mate. Material: latón.  
 Towel shelf with bar and 4 anchors 50 cm.  
 Finish: matte black. Material: brass.  
 150 x 530 x 228 mm.



**061311-N** ●●●●●  
 Toallero repisa con barra 50 cm.  
 Acabado: negro mate. Material: latón.  
 Towel shelf with bar 50 cm.  
 Finish: matte black. Material: brass.  
 134 x 552 x 270 mm.

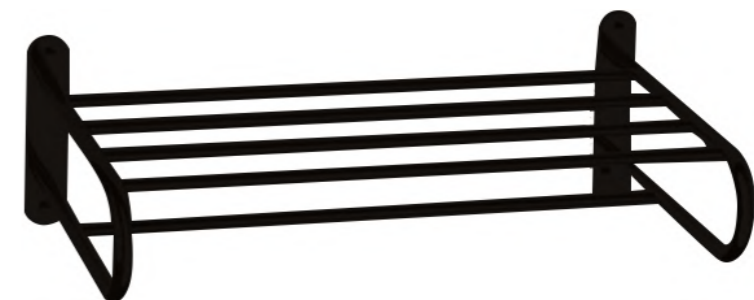

**061500-N** ●●●●●  
 Toallero repisa pletinas con barra 4 anclajes 50 cm.  
 Acabado: negro mate. Material: latón.  
 Towel shelf with bar and 4 anchors 50 cm.  
 Finish: matte black. Material: brass.  
 145 x 480 x 260 mm.



**061700-N** ●●

Asa recta 30 cm.  
Acabado: negro mate.  
Material: latón.  
Grab rail 30 cm.  
Finish: matte black.  
Material: brass.  
50 x 330 x 74 mm.

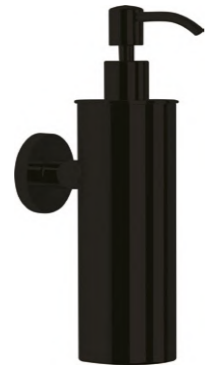

**502110-N** ●●●●

Dosificador pared 250 ml.  
Acabado: negro mate.  
Material: latón.  
Soap dispenser 250 ml.  
Finish: matte black.  
Material: brass.  
210 x 60 x 90 mm.

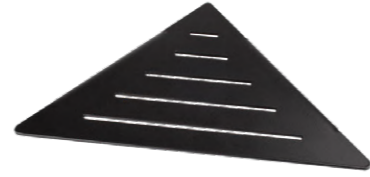

**064202-N** ●●

Esponjara rincón.  
Acabado: negro mate.  
Material: acero inoxidable.  
Corner shower basket.  
Finish: matte black.  
Material: stainless steel.  
25 x 250 x 180 mm.

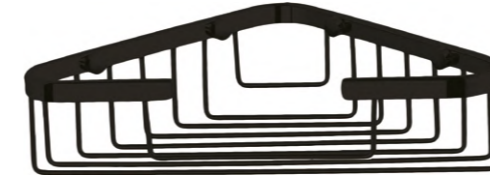

**064001-N** ●●

Esponjera rejilla rincón.  
Acabado: negro mate.  
Material: latón.  
Corner shower basket grid.  
Finish: matte black.  
Material: brass.  
63 x 195 x 195 mm.



**064100-N** ●●

Esponjera rejilla rectangular.  
Acabado: negro mate.  
Material: latón.  
Square shower basket grid.  
Finish: matte black.  
Material: brass.  
48 x 250 x 123 mm.

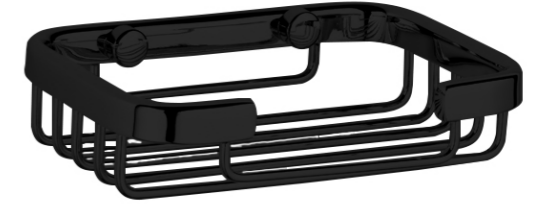

**065101-N** ●●

Esponjera rejilla rectangular pequeña.  
Acabado: negro mate.  
Material: latón.  
Small square shower basket grid.  
Finish: matte black.  
Material: brass.  
35 x 132 x 95 mm.



**064200-N** ●●

Esponjera rectangular.  
Acabado: negro mate.  
Material: acero inoxidable.  
Square shower basket.  
Finish: matte black.  
Material: stainless steel.  
50 x 200 x 115 mm.



**064204-N-N** ●●●●

Esponjera rincón interior negro.  
Acabado: negro mate.  
Material: acero inoxidable y ABS.  
Corner shower basket with black interior.  
Finish: matte black.  
Material: stainless steel and ABS.  
52 x 220 x 220 mm.



**064205-N-N** ●●●●

Esponjera rectangular interior negro.  
Acabado: negro mate.  
Material: acero inoxidable y ABS.  
Square shower basket with black interior.  
Finish: matte black.  
Material: stainless steel and ABS.  
53 x 300 x 124 mm.



**062000-N** ●●●●

Escobillero pared/suelo redondo.  
Acabado: negro mate.  
Material: acero inoxidable.  
Round toilet brush holder wall/floor.  
Finish: matte black.  
Material: stainless steel.  
380 x 96 x 92 mm.



**066001-N** ●

Escobillero pared redondo TOP ONE.  
Acabado: negro mate.  
Material: acero inoxidable.  
Round floor toilet brush holder TOP ONE.  
Material: stainless steel.  
Material: brass.  
420 x 82 x 93 mm.

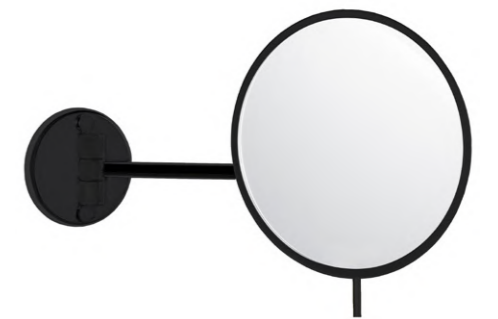

**200601-N** ●●

Espejo aumento slim joystick II.  
Aumentos: x3.  
Acabado: negro mate.  
Magnifying mirror slim joystick II.  
Magnifications: x3.  
Finish: matte black.  
Ø 18 cm.

# CUBIK latón cepillado

*Brushed brass*

**Perchas**  
**Portarrollos**  
**Toalleros**  
**Asas**  
**Esponjeras**  
**Escobilleros**  
**Espejos Aumento**

**Hangers**  
**Toilet roll holders**  
**Towel racks**  
**Grab rails**  
**Shower baskets**  
**Toilet brush holders**  
**Magnifying mirror**



**050100-LC** ●●●●  
Percha 90° CUBIK.  
Acabado: latón cepillado.  
Material: latón.  
90° robe hook CUBIK.  
Finish: brushed brass.  
Material: brass.  
58 x 52 x 69 mm.



**060201-LC** ●●●●  
Percha recta short.  
Acabado: latón cepillado.  
Material: latón.  
Short robe hook.  
Finish: brushed brass.  
Material: brass.  
52 x 52 x 44 mm.



**150200-LC** ●●●●  
Percha recta sin base.  
Acabado: latón cepillado.  
Material: latón.  
Robe hook without base.  
Finish: brushed brass.  
Material: brass.  
30 x 30 x 40 mm.



**070500-LC** ●●●●  
Portarrollos con tapa.  
Acabado: latón cepillado.  
Material: latón.  
Toilet roll holder with lid.  
Finish: brushed brass.  
Material: brass.  
160 x 140 x 54 mm.

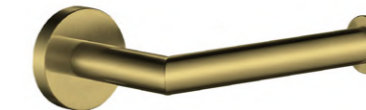

**051000-LC** ●●●●  
Portarrollos sin tapa CUBIK.  
Acabado: latón cepillado.  
Material: latón.  
Toilet roll holder without lid CUBIK.  
Finish: brushed brass.  
Material: brass.  
52 x 158 x 91 mm.



**051100-LC** ●●●●  
Portarrollos reserva CUBIK.  
Acabado: latón cepillado.  
Material: latón.  
Reserva toilet roll holder CUBIK.  
Finish: brushed brass.  
Material: brass.  
176 x 53 x 87 mm.

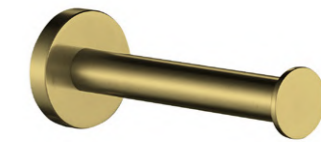

**022100-LC** ●●●●  
Portarrollos recto horizontal.  
Acabado: latón cepillado.  
Material: acero inoxidable.  
Horizontal toilet roll holder.  
Finish: brushed brass.  
Material: stainless steel.  
46 x 46 x 160 mm.

Estructura de dimensiones. alto/ancho/fondo.  
Dimension structure. height/width/depth.



**151001-LC** ●●●●●  
 Portarrollos eje elevable CUBIK.  
 Acabado: latón cepillado.  
 Material: latón.  
 Toilet roll holder with lift-up axis.  
 Finish: brushed brass.  
 Material: brass.  
 52 x 193 x 82 mm.

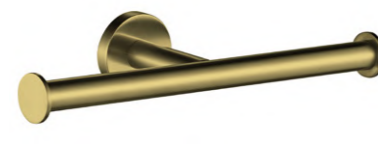

**051400-LC** ●●●●●  
 Portarrollos doble CUBIK.  
 Acabado: latón cepillado.  
 Material: latón.  
 Double toilet roll holder CUBIK.  
 Finish: brushed brass.  
 Material: brass.  
 52 x 267 x 94 mm.



**050400-LC** ●●●●●  
 Tollero anilla pequeña CUBIK.  
 Acabado: latón cepillado.  
 Material: latón.  
 Small towel ring CUBIK.  
 Finish: brushed brass.  
 Material: brass.  
 110 x 150 x 70 mm.

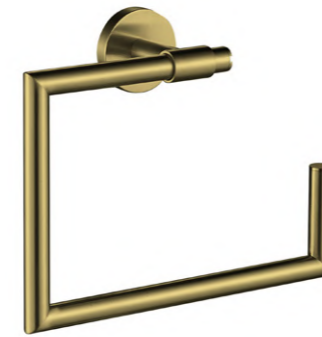

**050500-LC** ●●●●●  
 Toallero anilla grande CUBIK.  
 Acabado: latón cepillado.  
 Material: latón.  
 Big towel ring CUBIK.  
 Finish: brushed brass.  
 Material: brass.  
 180 x 225 x 70 mm.



**064204-LC-N** ●●●●●  
 Esponjera rincón interior negro.  
 Acabado: latón cepillado.  
 Material: acero inoxidable y ABS.  
 Corner shower basket with black interior.  
 Finish: brushed brass.  
 Material: stainless steel and ABS.  
 52 x 220 x 220 mm.

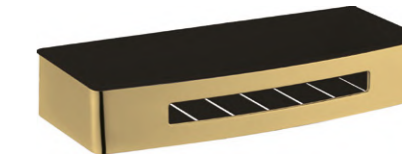

**064205-LC-N** ●●●●●  
 Esponjera rectangular interior negro.  
 Acabado: latón cepillado.  
 Material: acero inoxidable y ABS.  
 Square shower basket with black interior.  
 Finish: brushed brass.  
 Material: stainless steel and ABS.  
 53 x 300 x 124 mm.

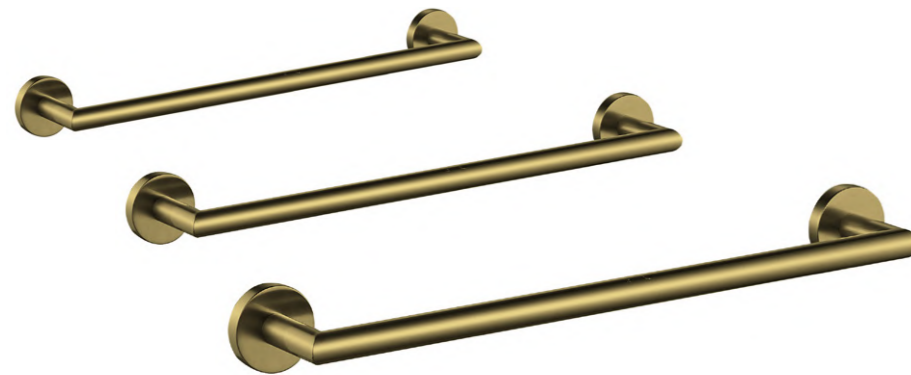

**050600-LC** ●●●●●  
 Toallero barra CUBIK 30 cm.  
 Acabado: latón cepillado.  
 Material: latón.  
 Towel bar CUBIK 30 cm.  
 Finish: brushed brass.  
 Material: brass.  
 52 x 333 x 70 mm.

**050700-LC** ●●●●●  
 Toallero barra CUBIK 45 cm.  
 Acabado: latón cepillado.  
 Material: latón.  
 Towel bar CUBIK 45 cm.  
 Finish: brushed brass.  
 Material: brass.  
 52 x 463 x 70 mm.

**050800-LC** ●●●●●  
 Toallero barra CUBIK 60 cm.  
 Acabado: latón cepillado.  
 Material: latón.  
 Towel bar CUBIK 60 cm.  
 Finish: brushed brass.  
 Material: brass.  
 52 x 613 x 70 mm.



**052200-LC** ●●●●●  
 Toallero barra doble CUBIK.  
 Acabado: latón cepillado.  
 Material: latón.  
 Double towel bar CUBIK.  
 Finish: brushed brass.  
 Material: brass.  
 52 x 613 x 118 mm.

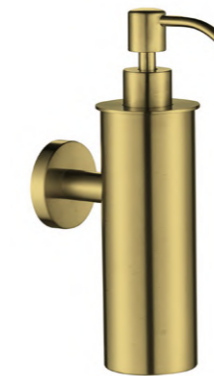

**502110-LC** ●●●●●  
 Dosificador pared 250 ml.  
 Acabado: latón cepillado.  
 Material: latón.  
 Soap dispenser 250 ml.  
 Finish: brushed brass.  
 Material: brass.  
 210 x 60 x 90 mm.



**062000-LC** ●●●●●  
 Escobillero pared/suelo redondo.  
 Acabado: latón cepillado.  
 Material: acero inoxidable.  
 Round toilet brush holder wall/floor.  
 Finish: brushed brass.  
 Material: stainless steel.  
 380 x 96 x 92 mm.



**204003-LC** ●●●●●  
 Espejo aumento DIVA EVOLUTION 1 brazo.  
 Aumentos: x3.  
 Acabado: latón cepillado.  
 Magnifying mirror DIVA EVOLUTION and 1 arm.  
 Magnifications: x3.  
 Finish: brushed brass.  
 Ø 21,5 cm.

# CUBIK cobre cepillado

*Brushed copper*

**Perchas**  
**Portarrollos**  
**Toalleros**  
**Esponjeras**  
**Escobillero**  
**Espejo Aumento**

*Hangers*  
*Toilet roll holders*  
*Towel racks*  
*Shower baskets*  
*Toilet brush holders*  
*Magnifying mirror*

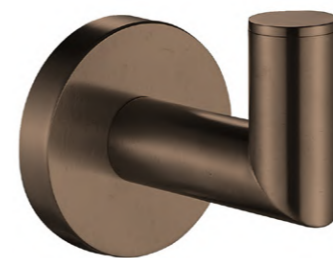
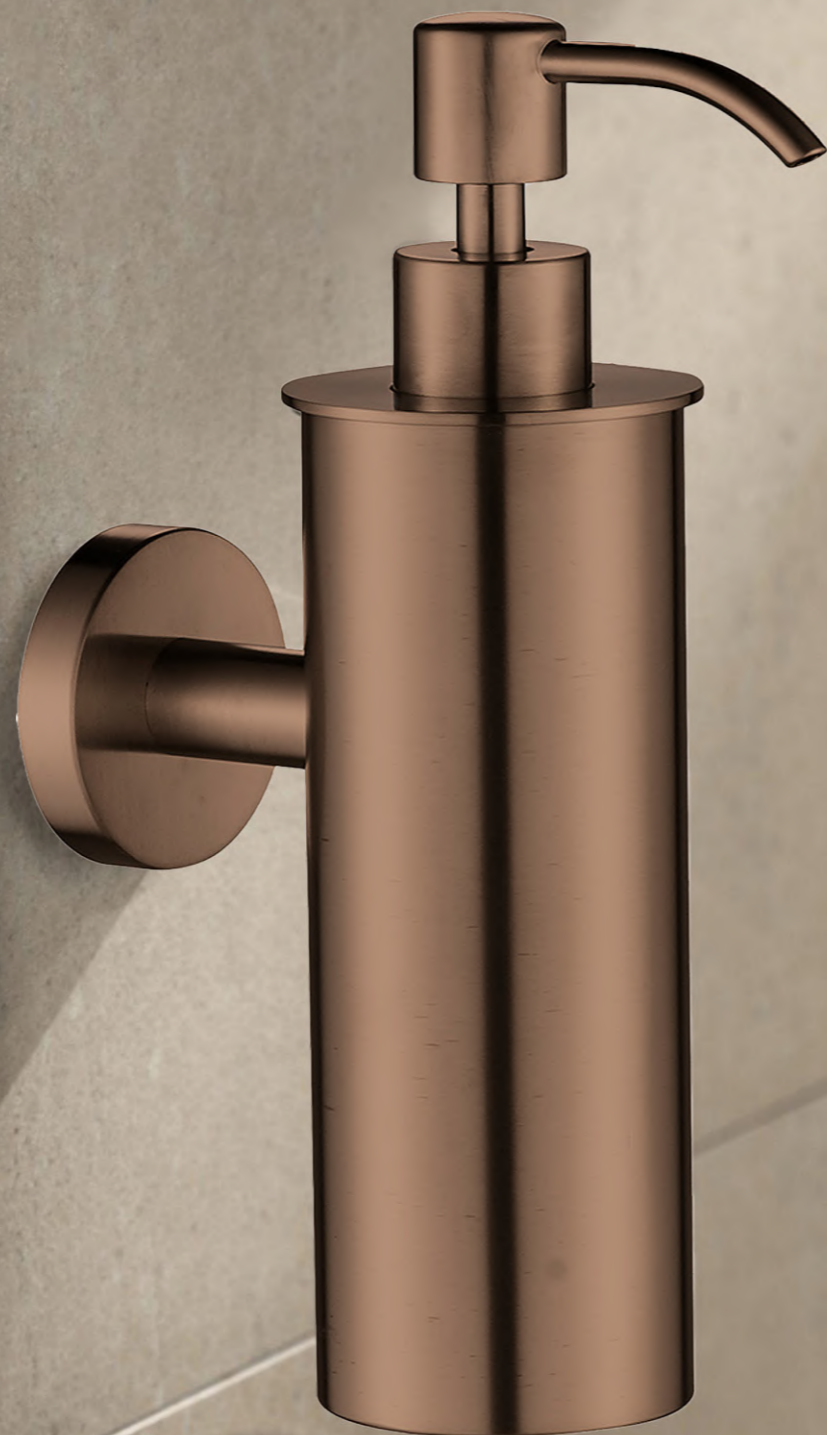

**050100-CC** ● ● ● ●  
Percha 90° CUBIK.  
Acabado: cobre cepillado.  
Material: latón.  
90° robe hook CUBIK.  
Finish: brushed copper.  
Material: brass.  
58 x 52 x 69 mm.



**060201-CC** ● ● ● ●  
Percha recta short.  
Acabado: cobre cepillado.  
Material: latón.  
Short robe hook.  
Finish: brushed copper.  
Material: brass.  
52 x 52 x 44 mm.



**150200-CC** ● ● ● ●  
Percha recta sin base.  
Acabado: cobre cepillado.  
Material: latón.  
Robe hook without base.  
Finish: brushed copper.  
Material: brass.  
30 x 30 x 40 mm.



**070500-CC** ● ● ● ●  
Portarrollos con tapa.  
Acabado: cobre cepillado.  
Material: latón.  
Toilet roll holder with lid.  
Finish: brushed copper.  
Material: brass.  
160 x 140 x 54 mm.

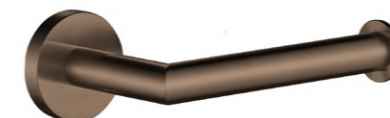

**051000-CC** ● ● ● ●  
Portarrollos sin tapa CUBIK.  
Acabado: cobre cepillado.  
Material: latón.  
Toilet roll holder without lid CUBIK.  
Finish: brushed copper.  
Material: brass.  
52 x 158 x 91 mm.



**051100-CC** ● ● ● ●  
Portarrollos reserva CUBIK.  
Acabado: cobre cepillado.  
Material: latón.  
Reserva toilet roll holder CUBIK.  
Finish: brushed copper.  
Material: brass.  
176 x 53 x 87 mm.

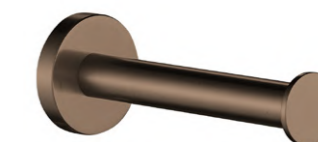

**022100-CC** ● ● ● ●  
Portarrollos recto horizontal.  
Acabado: cobre cepillado.  
Material: acero inoxidable.  
Horizontal toilet roll holder.  
Finish: brushed copper.  
Material: stainless steel.  
46 x 46 x 160 mm.

Estructura de dimensiones. alto/ancho/fondo.  
Dimension structure. height/width/depth.



**151001-CC** ●●●●●

Portarrollos eje elevable CUBIK.  
Acabado: cobre cepillado.  
Material: latón.  
Toilet roll holder with lift-up axis.  
Finish: brushed copper.  
Material: brass.  
52 x 193 x 82 mm.



**051400-CC** ●●●●●

Portarrollos doble CUBIK.  
Acabado: cobre cepillado.  
Material: latón.  
Double toilet roll holder CUBIK.  
Finish: brushed copper.  
Material: brass.  
52 x 267 x 94 mm.

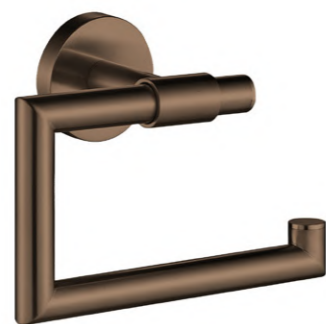

**050400-CC** ●●●●●

Tollero anilla pequeña CUBIK.  
Acabado: cobre cepillado.  
Material: latón.  
Small towel ring CUBIK.  
Finish: brushed copper.  
Material: brass.  
110 x 150 x 70 mm.

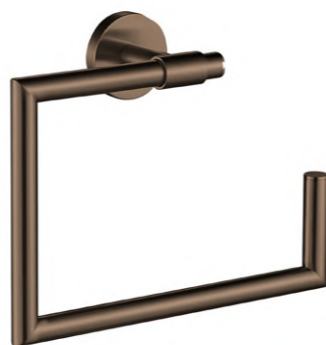

**050500-CC** ●●●●●

Toallero anilla grande CUBIK.  
Acabado: cobre cepillado.  
Material: latón.  
Big towel ring CUBIK.  
Finish: brushed copper.  
Material: brass.  
180 x 225 x 70 mm.



**064204-CC-N** ●●●●●

Esponjera rincón interior negro.  
Acabado: cobre cepillado.  
Material: acero inoxidable y ABS.  
Corner shower basket with black interior.  
Finish: brushed copper.  
Material: stainless steel and ABS.  
52 x 220 x 220 mm.

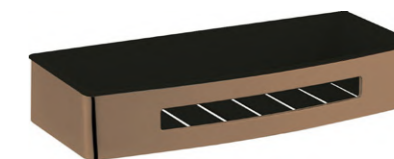

**064205-CC-N** ●●●●●

Esponjera rectangular interior negro.  
Acabado: cobre cepillado.  
Material: acero inoxidable y ABS.  
Square shower basket with black interior.  
Finish: brushed copper.  
Material: stainless steel and ABS.  
53 x 300 x 124 mm.

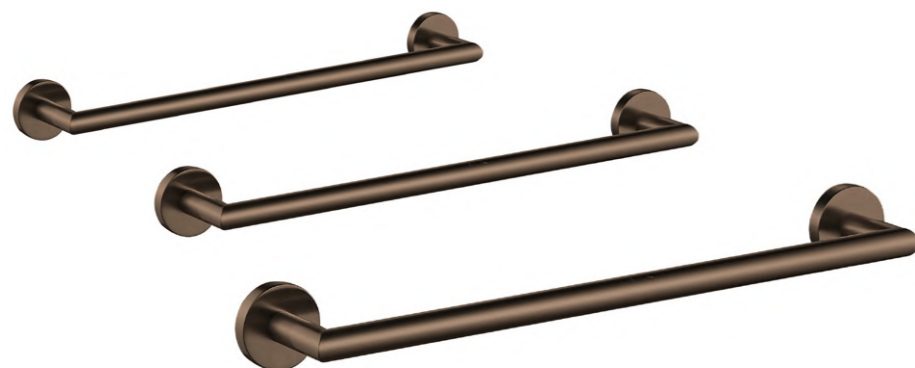

**050600-CC** ●●●●●

Toallero barra CUBIK 30 cm.  
Acabado: cobre cepillado.  
Material: latón.  
Towel bar CUBIK 30 cm.  
Finish: brushed copper.  
Material: brass.  
52 x 333 x 70 mm.

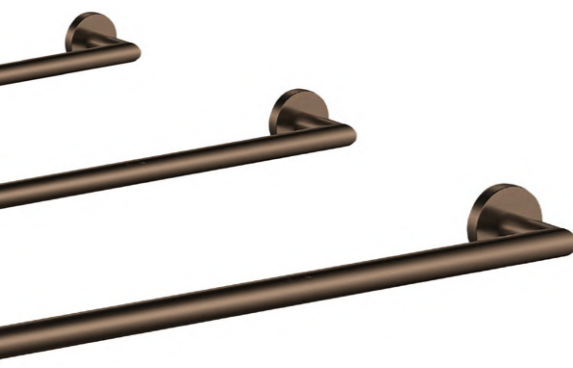

**050700-CC** ●●●●●

Toallero barra CUBIK 45 cm.  
Acabado: cobre cepillado.  
Material: latón.  
Towel bar CUBIK 45 cm.  
Finish: brushed copper.  
Material: brass.  
52 x 463 x 70 mm.

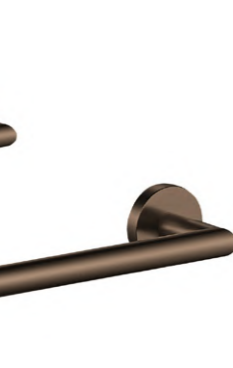

**050800-CC** ●●●●●

Toallero barra CUBIK 60 cm.  
Acabado: cobre cepillado.  
Material: latón.  
Towel bar CUBIK 60 cm.  
Finish: brushed copper.  
Material: brass.  
52 x 613 x 70 mm.

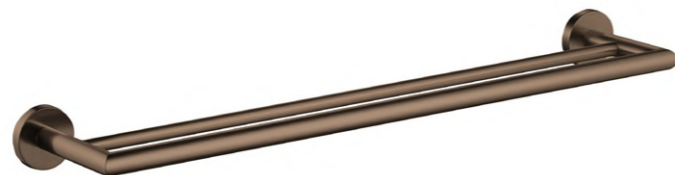

**052200-CC** ●●●●●

Toallero barra doble CUBIK.  
Acabado: cobre cepillado.  
Material: latón.  
Double towel bar CUBIK.  
Finish: brushed copper.  
Material: brass.  
52 x 613 x 118 mm.

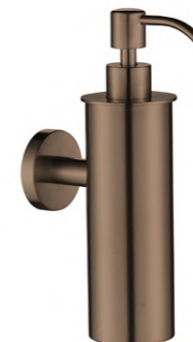

**502110-CC** ●●●●●

Dosificador pared 250 ml.  
Acabado: cobre cepillado.  
Material: latón.  
Soap dispenser 250 ml.  
Finish: brushed copper.  
Material: brass.  
210 x 60 x 90 mm.



**062000-CC** ●●●●●

Escobillero pared/suelo redondo.  
Acabado: cobre cepillado.  
Material: acero inoxidable.  
Round toilet brush holder wall/floor.  
Finish: brushed copper.  
Material: stainless steel.  
380 x 96 x 92 mm.



**204003-CC** ●●●●●

Espejo aumento DIVA EVOLUTION 1 brazo.  
Aumentos: x3.  
Acabado: cobre cepillado.  
Magnifying mirror DIVA EVOLUTION and 1 arm.  
Magnifications: x3.  
Finish: brushed copper.  
Ø 21,5 cm.

# NOA

NOA es una serie de accesorios de baño fabricada en latón que destaca por su carácter atemporal y su capacidad de integrarse en cualquier ambiente. Ofrece soluciones modernas y prácticas que se adaptan perfectamente a las necesidades de un baño contemporáneo.

Esta serie está disponible en varios acabados favoreciendo una gran flexibilidad en la combinación de estilos y ambientes en baños funcionales, modernos y atemporales.

*NOA is a series of bathroom accessories made of brass that stands out for its timeless character and its ability to blend into any environment. It offers modern and practical solutions that adapt perfectly to the needs of a contemporary bathroom.*

*This series is available in several finishes favouring a great flexibility in the combination of styles and atmospheres in functional, modern and timeless bathrooms.*

Los acabados especiales, cobre cepillado y latón cepillado, cuentan con un recubrimiento PVD (deposición física de vapor), que proporciona una mayor resistencia a la corrosión, asegurando una longevidad superior y manteniendo un aspecto impecable incluso con un uso intensivo.

La serie está disponible en los siguientes acabados:  
Para otros acabados, consultar con equipo comercial.

*The special finishes, brushed copper and brushed brass, feature a PVD (physical vapor deposition) coating, which provides increased corrosion resistance, ensures superior longevity and maintains a flawless appearance even with intensive use.*

*Series available in the following finishes:  
For other finishes, please contact our sales team.*

**Cromo brillo**  
*Bright chrome*



**Negro mate**  
*Matte Black*



**Blanco mate**  
*Matte white*



**Latón cepillado**  
*Brushed brass*



**Cobre cepillado**  
*Brushed copper*



# NOA

## Cromo brillo

### *bright chrome*

**Perchas**  
**Portarrollos**  
**Toalleros**  
**Jaboneras**  
**Asas**  
**Escobilleros**

**Hangers**  
**Toilet roll holders**  
**Towel racks**  
**Shower baskets**  
**Grab rails**  
**Toilet brush holders**



**050100** ● ● ○ ● ●  
 Percha 90°.  
 Acabado: cromo brillo.  
 Material: latón.  
 90° robe hook.  
 Finish: bright chrome.  
 Material: brass.  
 58 x 52 x 69 mm.



**060201** ● ● ○ ● ●  
 Percha recta short.  
 Acabado: cromo brillo.  
 Material: latón.  
 Short robe hook.  
 Finish: bright chrome.  
 Material: brass.  
 52 x 52 x 44 mm.



**150200** ● ● ○ ● ●  
 Percha recta sin base.  
 Acabado: cromo brillo.  
 Material: latón.  
 Robe hook without base.  
 Finish: bright chrome.  
 Material: brass.  
 30 x 30 x 40 mm.



**060301** ● ● ○ ● ●  
 Percha doble.  
 Acabado: cromo brillo.  
 Material: latón.  
 Double hook.  
 Finish: bright chrome.  
 Material: brass.  
 59 x 71 x 51 mm.



**508400** ● ● ○ ● ●  
 Portarrollos cuadrado con tapa.  
 Acabado: cromo brillo.  
 Material: acero inoxidable.  
 Square toilet roll holder with lid.  
 Finish: bright chrome.  
 Material: stainless steel.  
 80 x 130 x 130 mm.



**051501** ● ● ○ ● ●  
 Portarrollos sin base con tapa.  
 Acabado: cromo brillo.  
 Material: latón.  
 Toilet roll holder without base with lid.  
 Finish: bright chrome.  
 Material: brass.  
 66 x 137 x 91 mm.



**070500** ● ● ○ ● ●  
 Portarrollos con tapa.  
 Acabado: cromo brillo.  
 Material: latón.  
 Toilet roll holder with lid.  
 Finish: bright chrome.  
 Material: brass.  
 160 x 140 x 54 mm.

Estructura de dimensiones. alto/ancho/fondo.  
 Dimension structure. height/width/depth.



**061000** ● ● ○ ● ●

Portarrollos 90° sin tapa NOA.  
Acabado: cromo brillo.  
Material: latón.  
90° toilet roll holder without lid NOA.  
Finish: bright chrome.  
Material: brass.  
53 x 160 x 85 mm.



**061100** ● ● ○ ● ●

Portarrollos reserva NOA.  
Acabado: cromo brillo.  
Material: latón.  
Reserva toilet roll holder NOA.  
Finish: bright chrome.  
Material: brass.  
180 x 53 x 90 mm.



**051400** ● ● ○ ● ●

Portarrollos doble.  
Acabado: cromo brillo.  
Material: latón.  
Double toilet roll holder.  
Finish: bright chrome.  
Material: brass.  
52 x 267 x 94 mm.



**060600** ● ● ○ ● ●

Toallero barra NOA 30 cm.  
Acabado: cromo brillo.  
Material: latón.  
Towel bar NOA 30 cm.  
Finish: bright chrome.  
Material: brass.  
52 x 330 x 70 mm.

**060700** ● ● ○ ● ●

Toallero barra NOA 45 cm.  
Acabado: cromo brillo.  
Material: latón.  
Towel bar NOA 45 cm.  
Finish: bright chrome.  
Material: brass.  
52 x 463 x 70 mm.

**060800** ● ● ○ ● ●

Toallero barra NOA 60 cm.  
Acabado: cromo brillo.  
Material: latón.  
Towel bar NOA 60 cm.  
Finish: bright chrome.  
Material: brass.  
52 x 613 x 70 mm.

**060801** ● ● ○ ● ●

Toallero barra NOA 80 cm.  
Acabado: cromo brillo.  
Material: latón.  
Towel bar NOA 80 cm.  
Finish: bright chrome.  
Material: brass.  
52 x 793 x 70 mm.



**070300** ● ● ○ ● ●

Toallero anilla grande.  
Acabado: cromo brillo.  
Material: latón.  
Big towel ring.  
Finish: bright chrome.  
Material: brass.  
200 x 200 x 63 mm.



**060400** ● ● ○ ● ●

Toallero anilla pequeño.  
Acabado: cromo brillo.  
Material: latón.  
Small towel ring.  
Finish: bright chrome.  
Material: brass.  
110 x 150 x 70 mm.



**060500** ● ● ○ ● ●

Toallero anilla grande.  
Acabado: cromo brillo.  
Material: latón.  
Big towel ring.  
Finish: bright chrome.  
Material: brass.  
180 x 225 x 70 mm.



**151200** ● ● ○ ● ●

Toallero repisa con barra cuatro anclajes 50 cm.  
Acabado: cromo brillo.  
Material: latón.  
Towel shelf with bar four anchors 50 cm.  
Finish: bright chrome.  
Material: brass.  
150 x 530 x 228 mm.

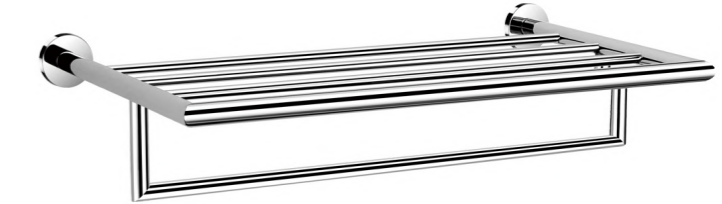

**061311** ● ● ○ ● ●

Toallero repisa con barra NOA 50 cm.  
Acabado: cromo brillo.  
Material: latón.  
Towel shelf with bar NOA 50 cm.  
Finish: bright chrome.  
Material: brass.  
134 x 552 x 270 mm.

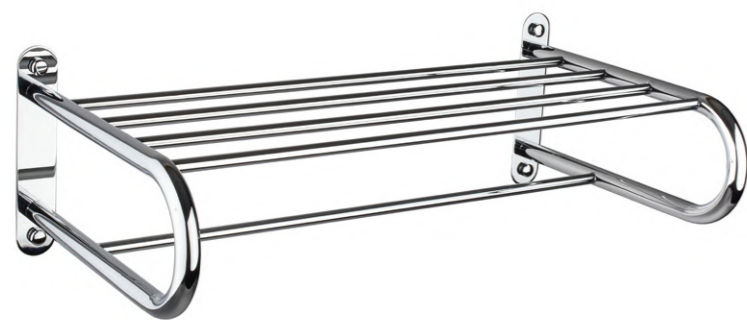

**061500** ● ● ○ ● ●  
Toallero repisa pletinas con barra 4 anclajes NOA 50 cm.  
Acabado: cromo brillo.  
Material: latón.  
Towel shelf with bar 4 anchors NOA 50 cm.  
Finish: bright chrome.  
Material: brass.  
145 x 480 x 260 mm.

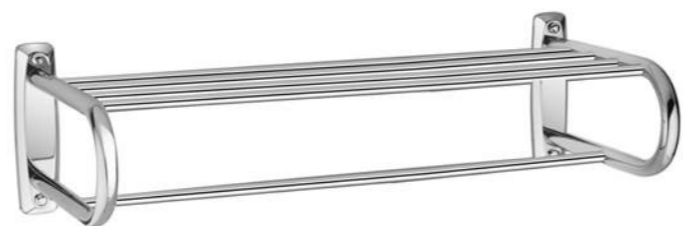

**061501** ● ● ○ ● ●  
Toallero repisa con barra 50 cm.  
Acabado: cromo brillo.  
Material: acero inoxidable.  
Towel shelf with bar 50 cm.  
Finish: bright chrome.  
Material: stainless steel.  
180 x 510 x 270 mm.

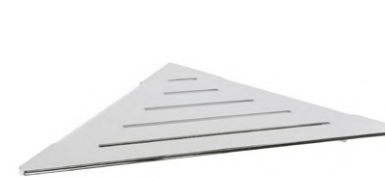

**064202** ● ● ○  
Esponjera rincón.  
Acabado: cromo brillo.  
Material: acero inoxidable.  
Corner shower basket.  
Finish: bright chrome.  
Material: stainless steel.  
25 x 250 x 180 mm.



**064200** ● ● ○  
Esponjera rectangular.  
Acabado: cromo brillo.  
Material: acero inoxidable.  
Square shower basket.  
Finish: bright chrome.  
Material: stainless steel.  
50 x 200 x 115 mm.



**064204-INT-N** ● ● ○ ● ●  
Esponjera rincón interior negro.  
Acabado: cromo brillo.  
Material: acero inoxidable y ABS.  
Corner metro shower basket with black interior.  
Finish: bright chrome.  
Material: stainless steel and ABS.  
52 x 220 x 220 mm.



**064205** ● ● ○ ● ●  
Esponjera rectangular interior negro.  
Acabado: cromo brillo.  
Material: acero inoxidable y ABS.  
Square metro shower basket with black interior.  
Finish: bright chrome.  
Material: stainless steel and ABS.  
53 x 300 x 124 mm.



**061700** ● ● ○ ● ●  
Asa recta 30 cm.  
Acabado: cromo brillo.  
Material: latón.  
Grab rail 30 cm.  
Finish: bright chrome.  
Material: brass.  
50 x 330 x 74 mm.



**061800** ● ● ○ ● ●  
Asa bañera curva.  
Acabado: cromo brillo.  
Material: latón.  
Grab rail for bathtub.  
Finish: bright chrome.  
Material: brass.  
125 x 425 x 70 mm.



**061900** ● ● ○ ● ●  
Asa bañera curva con jabonera.  
Acabado: cromo brillo.  
Material: latón.  
Grab rail with shower basket.  
Finish: bright chrome.  
Material: brass.  
200 x 430 x 120 mm.



**064001** ● ● ○  
Esponjera rejilla rincón.  
Acabado: cromo brillo.  
Material: latón.  
Corner shower basket.  
Finish: bright chrome.  
Material: brass.  
63 x 195 x 195 mm.



**064100** ● ● ○  
Esponjera rejilla rectangular.  
Acabado: cromo brillo.  
Material: latón.  
Rectangular shower basket.  
Finish: bright chrome.  
Material: brass.  
48 x 250 x 123 mm.



**065101** ● ● ○  
Esponjera rejilla rectangular pequeña.  
Acabado: cromo brillo.  
Material: latón.  
Small rectangular shower basket.  
Finish: bright chrome.  
Material: brass.  
35 x 132 x 95 mm.



**502110** ● ● ○ ● ●  
Dosificador pared 250 ml.  
Acabado: cromo brillo.  
Material: latón.  
Soap dispenser 250 ml.  
Finish: bright chrome.  
Material: brass.  
210 x 60 x 90 mm.



**062000-SIL** ●●○●●  
 Escobillero pared-suelo inox brillo tapa silicona.  
 Acabado: cromo brillo.  
 Material: acero inoxidable.  
 Toilet brush holder wall/floor.  
 Finish: bright chrome.  
 Material: stainless steel.  
 380 x 96 x 92 mm.



**062000** ●●○●●  
 Escobillero pared/suelo redondo.  
 Acabado: cromo brillo.  
 Material: acero inoxidable.  
 Round toilet brush holder wall/floor.  
 Finish: bright chrome.  
 Material: stainless steel.  
 380 x 96 x 92 mm.



**063001** ●●○●●  
 Escobillero pared/suelo redondo abocardado.  
 Acabado: cromo brillo.  
 Material: acero inoxidable.  
 Round toilet brush holder wall/floor.  
 Finish: bright chrome.  
 Material: stainless steel.  
 380 x 96 x 96 mm.

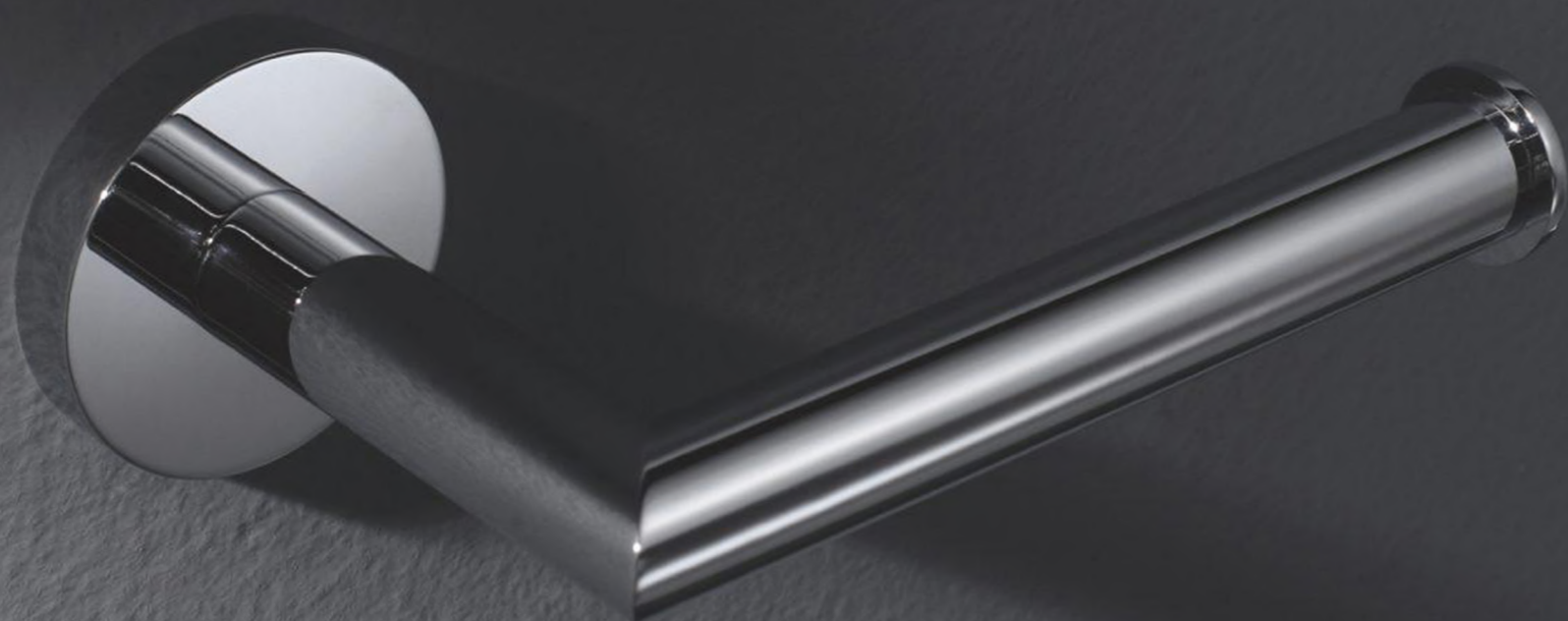

AIR es una serie de accesorios de baño fabricada en latón con un diseño de líneas suaves y redondeadas. Destaca por su diseño contemporáneo que aporta una sensación de ligereza y armonía a cualquier cuarto de baño.

Disponible en diferentes acabados, esta serie ofrece una gran versatilidad para combinar en una amplia gama de estilos de diseño de interiores de baños de hoteles.

*AIR is a series of bathroom accessories made of brass with a design of soft, rounded lines. It stands out for its contemporary design that brings a sense of lightness and harmony to any bathroom.*

*Available in different finishes, this series offers great versatility to combine in a wide range of hotel bathroom interior design styles.*

Los acabados especiales, cobre cepillado y latón cepillado, cuentan con un recubrimiento PVD (deposición física de vapor), que proporciona una mayor resistencia a la corrosión, asegurando una longevidad superior y manteniendo un aspecto impecable incluso con un uso intensivo.

La serie está disponible en los siguientes acabados:  
Para otros acabados, consultar con equipo comercial.

*The special finishes, brushed copper and brushed brass, feature a PVD (physical vapor deposition) coating, which provides increased corrosion resistance, ensures superior longevity and maintains a flawless appearance even with intensive use.*

*Series available in the following finishes:  
For other finishes, please contact our sales team.*

**Cromo brillo**  
*Bright chrome*



**Negro mate**  
*Matte Black*



**Blanco mate**  
*Matte white*



**Latón cepillado**  
*Brushed brass*



**Cobre cepillado**  
*Brushed copper*



# AIR

# AIR

## chromo brillo

*bright chrome*

**Perchas**  
**Portarrollos**  
**Toalleros**  
**Jaboneras**  
**Asas**  
**Dispensadores**  
**Escobilleros**

**Hangers**  
**Toilet roll holders**  
**Towel racks**  
**Shower baskets**  
**Grab rails**  
**Dispensers**  
**Toilet brush holders**



**050100** ●●●●●  
 Percha 90°.  
 Acabado: cromo brillo.  
 Material: latón.  
 90° robe hook.  
 Finish: bright chrome.  
 Material: brass.  
 58 x 52 x 69 mm.

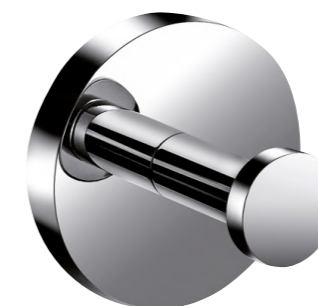

**060201** ●●●●●  
 Percha recta short.  
 Acabado: cromo brillo.  
 Material: latón.  
 Short robe hook.  
 Finish: bright chrome.  
 Material: brass.  
 52 x 52 x 44 mm.



**150200** ●●●●●  
 Percha recta sin base.  
 Acabado: cromo brillo.  
 Material: latón.  
 Robe hook without base.  
 Finish: bright chrome.  
 Material: brass.  
 30 x 30 x 40 mm.



**051500** ●●●●●  
 Portarrollos con tapa elevable.  
 Acabado: cromo brillo.  
 Material: latón.  
 Toilet roll holder with lid.  
 Finish: bright chrome.  
 Material: brass.  
 65 x 130 x 120 mm.



**051501** ●●●●●  
 Portarrollos sin base con tapa.  
 Acabado: cromo brillo.  
 Material: latón.  
 Toilet roll holder without base with lid.  
 Finish: bright chrome.  
 Material: brass.  
 66 x 137 x 91 mm.



**070500** ●●●●●  
 Portarrollos con tapa.  
 Acabado: cromo brillo.  
 Material: latón.  
 Toilet roll holder with lid.  
 Finish: bright chrome.  
 Material: brass.  
 160 x 140 x 54 mm.

Estructura de dimensiones. alto/ancho/fondo.  
 Dimension structure. height/width/depth.



**071000** ●●○●●  
 Portarrollos 90° sin tapa AIR.  
 Acabado: cromo brillo.  
 Material: latón.  
 Toilet roll holder without lid AIR.  
 Finish: bright chrome.  
 Material: brass.  
 52 x 167 x 100 mm.



**070400** ●●○●●  
 Portarrollos reserva AIR.  
 Acabado: cromo brillo.  
 Material: latón.  
 Reserva toilet roll holder AIR.  
 Finish: bright chrome.  
 Material: brass.  
 160 x 50 x 75 mm.

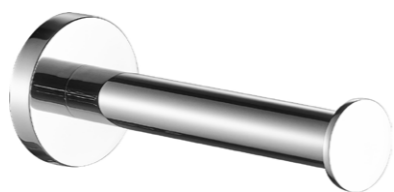

**022100** ●●○●●  
 Portarrollos recto horizontal.  
 Acabado: cromo brillo.  
 Material: acero inoxidable.  
 Horizontal toilet roll holder.  
 Finish: bright chrome.  
 Material: stainless steel.  
 46 x 46 x 160 mm.



**151001** ●●○●●  
 Portarrollos eje elevable.  
 Acabado: cromo brillo.  
 Material: latón.  
 Toilet roll holder with lift-up axis.  
 Finish: bright chrome.  
 Material: brass.  
 52 x 193 x 82 mm.

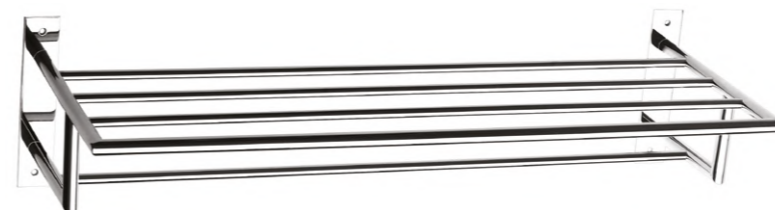

**151200** ●●○●●  
 Toallero repisa con barra cuatro anclajes 50 cm.  
 Acabado: cromo brillo.  
 Material: latón.  
 Towel shelf with bar four anchors 50 cm.  
 Finish: bright chrome.  
 Material: brass.  
 150 x 530 x 228 mm.

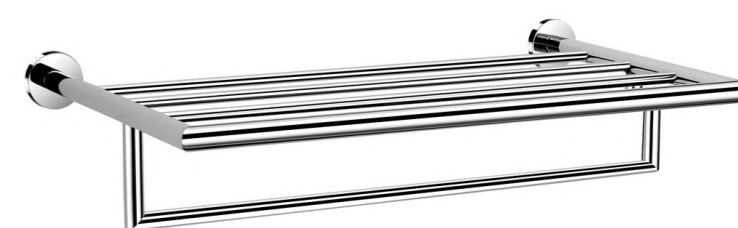

**061311** ●●○●●  
 Toallero repisa con barra 50 cm.  
 Acabado: cromo brillo.  
 Material: latón.  
 Towel shelf with bar 50 cm.  
 Finish: bright chrome.  
 Material: brass.  
 134 x 552 x 270 mm.



**051400** ●●○●●  
 Portarrollos doble.  
 Acabado: cromo brillo.  
 Material: latón.  
 Double toilet roll holder.  
 Finish: bright chrome.  
 Material: brass.  
 52 x 267 x 94 mm.



**070300** ●●○●●  
 Toallero anilla grande AIR.  
 Acabado: cromo brillo.  
 Material: latón.  
 Big towel ring AIR.  
 Finish: bright chrome.  
 Material: brass.  
 220 x 200 x 63 mm.



●●○●●  
**070600**  
 Toallero barra 30 cm AIR.  
 Acabado: cromo brillo.  
 Material: latón.  
 Towel bar 30 cm AIR.  
 Finish: bright chrome.  
 Material: brass.  
 50 x 330 x 75 mm.

●●○●●  
**070700**  
 Toallero barra 50 cm AIR.  
 Acabado: cromo brillo.  
 Material: latón.  
 Towel bar 45 cm AIR.  
 Finish: bright chrome.  
 Material: brass.  
 50 x 500 x 75 mm.

●●○●●  
**070800**  
 Toallero barra 60 cm AIR.  
 Acabado: cromo brillo.  
 Material: latón.  
 Towel bar 60 cm AIR.  
 Finish: bright chrome.  
 Material: brass.  
 50 x 630 x 75 mm.

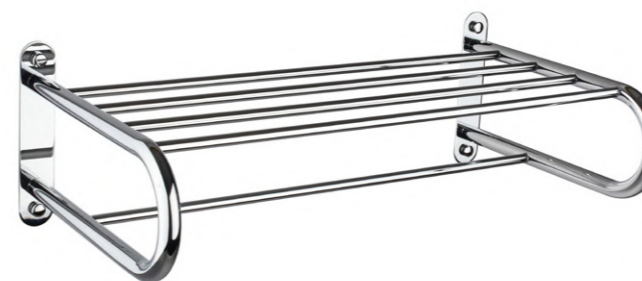

**061500** ●●○●●  
 Toallero repisa pletinas con barra 4 anclajes 50 cm.  
 Acabado: cromo brillo.  
 Material: latón.  
 Towel shelf with bar 4 anchors 50 cm.  
 Finish: bright chrome.  
 Material: brass.  
 145 x 480 x 260 mm.



**061700** ●●○●●  
 Asa recta 30 cm.  
 Acabado: cromo brillo.  
 Material: latón.  
 Grab rail 30 cm.  
 Finish: bright chrome.  
 Material: brass.  
 50 x 330 x 74 mm.



**061800** ● ● ○ ● ●  
 Asa bañera curva.  
 Acabado: cromo brillo.  
 Material: latón.  
 Grab rail for bathtub.  
 Finish: bright chrome.  
 Material: brass.  
 125 x 425 x 70 mm.



**061900** ● ● ○ ● ●  
 Asa bañera curva con jabonera.  
 Acabado: cromo brillo.  
 Material: latón.  
 Grab rail with shower basket.  
 Finish: bright chrome.  
 Material: brass.  
 200 x 430 x 120 mm.

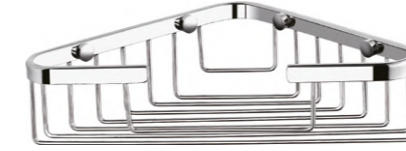

**064001** ● ● ○  
 Esponjara rejilla rincón.  
 Acabado: cromo brillo.  
 Material: latón.  
 Corner shower basket.  
 Finish: bright chrome.  
 Material: brass.  
 63 x 195 x 195 mm.



**064100** ● ● ○  
 Esponjara rejilla rectangular.  
 Acabado: cromo brillo.  
 Material: latón.  
 Rectangular shower basket.  
 Finish: bright chrome.  
 Material: brass.  
 48 x 250 x 123 mm.

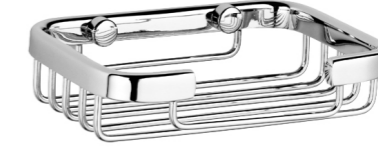

**065101** ● ● ○  
 Esponjara rejilla rectangular pequeña.  
 Acabado: cromo brillo.  
 Material: latón.  
 Small rectangular shower basket.  
 Finish: bright chrome.  
 Material: brass.  
 35 x 132 x 95 mm.



**502110** ● ● ○ ● ●  
 Dosificador pared 250 ml.  
 Acabado: cromo brillo.  
 Material: latón.  
 Soap dispenser 250 ml.  
 Finish: bright chrome.  
 Material: brass.  
 210 x 60 x 90 mm.



**064204-INT-N** ● ● ○ ● ●  
 Esponjara rincón interior negro.  
 Acabado: cromo brillo.  
 Material: acero inoxidable y ABS.  
 Corner shower basket.  
 Finish: bright chrome.  
 Material: stainless steel and ABS.  
 52 x 220 x 220 mm.



**064205** ● ● ○ ● ●  
 Esponjara rectangular interior negro.  
 Acabado: cromo brillo.  
 Material: acero inoxidable y ABS.  
 Square shower basket.  
 Finish: bright chrome.  
 Material: stainless steel and ABS.  
 53 x 300 x 124 mm.



**062000-SIL** ● ● ○ ● ●  
 Escobillero pared-suelo inox brillo tapa silicona.  
 Acabado: cromo brillo.  
 Material: acero inoxidable.  
 Toilet brush holder wall/floor.  
 Finish: bright chrome.  
 Material: stainless steel.  
 380 x 96 x 92 mm.



**062000** ● ● ○ ● ●  
 Escobillero pared/suelo redondo.  
 Acabado: cromo brillo.  
 Material: acero inoxidable.  
 Round toilet brush holder wall/floor.  
 Finish: bright chrome.  
 Material: stainless steel.  
 380 x 96 x 92 mm.



**063001** ● ● ○ ● ●  
 Escobillero pared/suelo redondo abocardado.  
 Acabado: cromo brillo.  
 Material: acero inoxidable.  
 Round toilet brush holder wall/floor.  
 Finish: bright chrome.  
 Material: stainless steel.  
 380 x 96 x 96 mm.

# AIR

## negro mate

*matte black*

**Perchas**  
**Portarrollos**  
**Toalleros**  
**Jaboneras**  
**Asas**  
**Dispensadores**  
**Escobilleros**

*Hangers*  
*Toilet roll holders*  
*Towel racks*  
*Shower baskets*  
*Grab rails*  
*Dispensers*  
*Toilet brush holders*

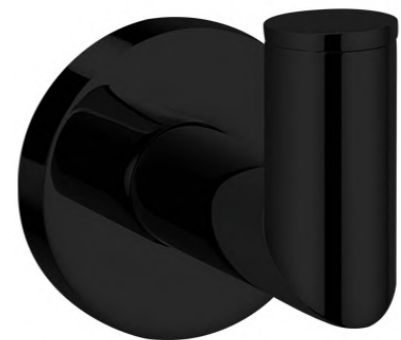

**050100-N** ● ○ ● ● ●  
 Percha 90°  
 Acabado: negro mate.  
 Material: latón.  
 90° robe hook.  
 Finish: matte black.  
 Material: brass.  
 58 x 52 x 69 mm.

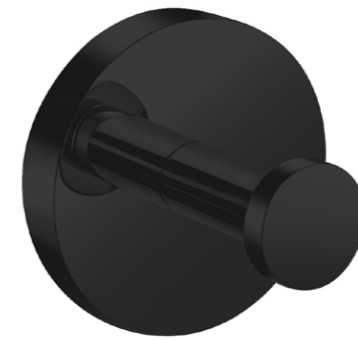

**060201-N** ● ○ ● ● ●  
 Percha recta short.  
 Acabado: negro mate.  
 Material: latón.  
 Short robe hook.  
 Finish: matte black.  
 Material: brass.  
 52 x 52 x 44 mm.



**150200-N** ● ○ ● ● ●  
 Percha recta sin base.  
 Acabado: negro mate.  
 Material: latón.  
 Robe hook without base.  
 Finish: matte black.  
 Material: brass.  
 30 x 30 x 40 mm.



**051500-N** ● ○ ● ● ●  
 Portarrollos con tapa elevable.  
 Acabado: negro mate.  
 Material: latón.  
 Toilet roll holder with lid.  
 Finish: matte black.  
 Material: brass.  
 65 x 130 x 120 mm.



**051501-N** ● ○ ● ● ●  
 Portarrollos sin base con tapa.  
 Acabado: negro mate.  
 Material: latón.  
 Toilet roll holder without base with lid.  
 Finish: matte black.  
 Material: brass.  
 66 x 137 x 91 mm.



**070500-N** ● ○ ● ● ●  
 Portarrollos con tapa.  
 Acabado: negro mate.  
 Material: latón.  
 Toilet roll holder with lid.  
 Finish: matte black.  
 Material: brass.  
 160 x 140 x 54 mm.

Estructura de dimensiones. alto/ancho/fondo.  
 Dimension structure. height/width/depth.



**071000-N** ●●○●●  
 Portarrollos 90° sin tapa AIR.  
 Acabado: negro mate.  
 Material: latón.  
 Toilet roll holder without lid AIR.  
 Finish: matte black.  
 Material: brass.  
 52 x 167 x 100 mm.



**070400-N** ●●○●●  
 Portarrollos reserva AIR.  
 Acabado: negro mate.  
 Material: latón.  
 Reserva toilet roll holder AIR.  
 Finish: matte black.  
 Material: brass.  
 160 x 50 x 75 mm.

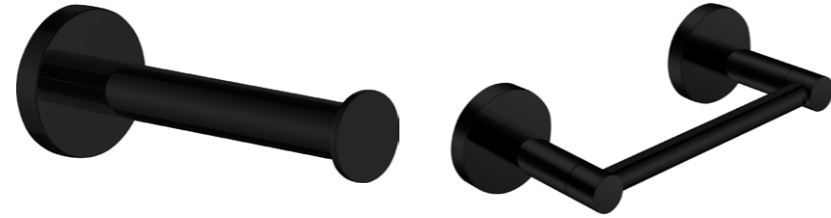

**022100-N** ●●○●●  
 Portarrollos recto horizontal.  
 Acabado: negro mate.  
 Material: acero inoxidable.  
 Horizontal toilet roll holder.  
 Finish: matte black.  
 Material: stainless steel.  
 46 x 46 x 160 mm.

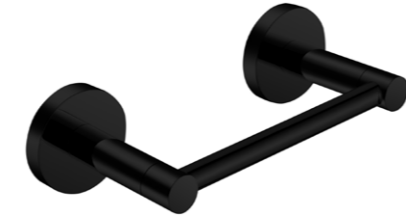

**151001-N** ●●○●●  
 Portarrollos eje elevable.  
 Acabado: negro mate.  
 Material: latón.  
 Toilet roll holder with lift-up axis.  
 Finish: matte black.  
 Material: brass.  
 52 x 193 x 82 mm.



**151200-N** ●●○●●  
 Toallero repisa con barra cuatro anclajes 50 cm.  
 Acabado: negro mate.  
 Material: latón.  
 Towel shelf with bar four anchors 50 cm.  
 Finish: matte black.  
 Material: brass.  
 150 x 530 x 228 mm.



**061311-N** ●●○●●  
 Toallero repisa con barra 50 cm.  
 Acabado: negro mate.  
 Material: latón.  
 Towel shelf with bar 50 cm.  
 Finish: matte black.  
 Material: brass.  
 134 x 552 x 270 mm.



**051400-N** ●●○●●  
 Portarrollos doble.  
 Acabado: negro mate.  
 Material: latón.  
 Double toilet roll holder.  
 Finish: matte black.  
 Material: brass.  
 52 x 267 x 94 mm.



**070300-N** ●●○●●  
 Toallero anilla grande AIR.  
 Acabado: negro mate.  
 Material: latón.  
 Big towel ring AIR.  
 Finish: matte black.  
 Material: brass.  
 200 x 200 x 63 mm.



●●○●●  
**070600-N**  
 Toallero barra 30 cm AIR.  
 Acabado: negro mate.  
 Material: latón.  
 Towel bar 30 cm AIR.  
 Finish: matte black.  
 Material: brass.  
 50 x 330 x 75 mm.

●●○●●  
**070700-N**  
 Toallero barra 50 cm AIR.  
 Acabado: negro mate.  
 Material: latón.  
 Towel bar 45 cm AIR.  
 Finish: matte black.  
 Material: brass.  
 50 x 500 x 75 mm.

●●○●●  
**070800-N**  
 Toallero barra 60 cm AIR.  
 Acabado: negro mate.  
 Material: latón.  
 Towel bar 60 cm AIR.  
 Finish: matte black.  
 Material: brass.  
 50 x 630 x 75 mm.

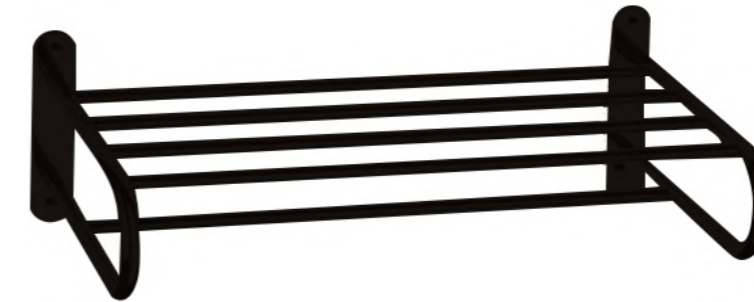

**061500-N** ●●○●●  
 Toallero repisa pletinas con barra 4 anclajes 50 cm.  
 Acabado: negro mate.  
 Material: latón.  
 Towel shelf with bar 4 anchors 50 cm.  
 Finish: matte black.  
 Material: brass.  
 145 x 480 x 260 mm.



**061700-N** ●●○●●  
 Asa recta 30 cm.  
 Acabado: negro mate.  
 Material: latón.  
 Grab rail 30 cm.  
 Finish: matte black.  
 Material: brass.  
 50 x 330 x 74 mm.



**061800-N** ● ○ ● ● ●  
 Asa bañera curva.  
 Acabado: negro mate.  
 Material: latón.  
 Grab rail for bathtub.  
 Finish: matte black.  
 Material: brass.  
 125 x 425 x 70 mm.



**061900-N** ● ○ ● ● ●  
 Asa bañera curva con jabonera.  
 Acabado: negro mate.  
 Material: latón.  
 Grab rail with shower basket.  
 Finish: matte black.  
 Material: brass.  
 200 x 430 x 120 mm.



**064001-N** ● ● ○  
 Esponjera rejilla rincón.  
 Acabado: negro mate.  
 Material: latón.  
 Corner shower basket.  
 Finish: matte black.  
 Material: brass.  
 63 x 195 x 195 mm.



**064100-N** ● ● ○  
 Esponjera rejilla rectangular.  
 Acabado: negro mate.  
 Material: latón.  
 Rectangular shower basket.  
 Finish: matte black.  
 Material: brass.  
 48 x 250 x 123 mm.

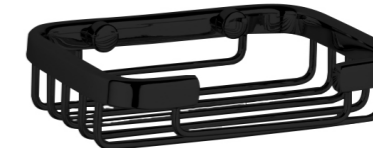

**065101-N** ● ● ○  
 Esponjera rejilla rectangular pequeña.  
 Acabado: negro mate.  
 Material: latón.  
 Small rectangular shower basket.  
 Finish: matte black.  
 Material: brass.  
 35 x 132 x 95 mm.

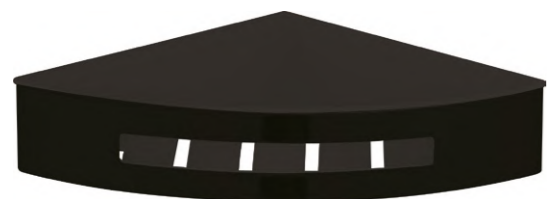

**064204-N-N** ● ● ○ ● ●  
 Esponjera rincón interior negro.  
 Acabado: negro mate.  
 Material: acero inoxidable y ABS.  
 Corner shower basket.  
 Finish: matte black.  
 Material: stainless steel and ABS.  
 52 x 220 x 220 mm.



**064205-N-N** ● ● ○ ● ●  
 Esponjera rectangular interior negro.  
 Acabado: negro mate.  
 Material: acero inoxidable y ABS.  
 Square shower basket.  
 Finish: matte black.  
 Material: stainless steel and ABS.  
 53 x 300 x 124 mm.

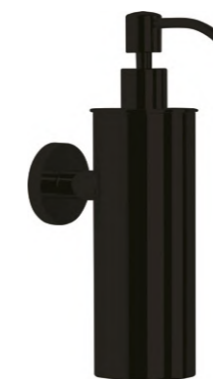

**502110-N** ● ● ○ ● ●  
 Dosificador pared 250 ml.  
 Acabado: negro mate.  
 Material: latón.  
 Soap dispenser 250 ml.  
 Finish: matte black.  
 Material: brass.  
 210 x 60 x 90 mm.



**062000-N** ● ● ○ ● ●  
 Escobillero pared/suelo redondo.  
 Acabado: negro mate.  
 Material: acero inoxidable.  
 Round toilet brush holder wall/floor.  
 Finish: matte black.  
 Material: stainless steel.  
 380 x 96 x 92 mm.



**063001-N** ● ● ○ ● ●  
 Escobillero pared/suelo redondo abocardado.  
 Acabado: negro mate.  
 Material: acero inoxidable.  
 Round toilet brush holder wall/floor.  
 Finish: matte black.  
 Material: stainless steel.  
 380 x 96 x 96 mm.

AVANT es una serie de accesorios de baño fabricada en latón con un diseño estructurado y geométrico. Con sus líneas rectas y acabados cuadrados ofrece un estilo sofisticado y elegante a cualquier espacio de baño.

Disponible en varios acabados que garantizan una personalización del entorno y que se adapta a la perfección con los estilos de diseño modernos, industriales o incluso, escandinavo.

*AVANT is a series of bathroom accessories made of brass with a structured and geometric design. With its straight lines and square finishes, it offers a sophisticated and elegant style to any bathroom space.*

*Available in several finishes that guarantee a personalised environment and that adapts perfectly to modern, industrial or even Scandinavian design styles.*

La serie está disponible en los siguientes acabados:  
Para otros acabados, consultar con equipo comercial.

*Series available in the following finishes:  
For other finishes, please contact our sales team.*

**Cromo brillo**  
*Bright chrome*



**Negro mate**  
*Matte Black*



**Blanco mate**  
*Matte white*



# AVANT

# AVANT

## Cromo brillo

*bright chrome*

**Perchas**  
**Portarrollos**  
**Toalleros**  
**Jaboneras**  
**Asas**  
**Dispensadores**  
**Escobilleros**

**Hangers**  
**Toilet roll holders**  
**Towel racks**  
**Shower baskets**  
**Grab rails**  
**Dispensers**  
**Toilet brush holders**

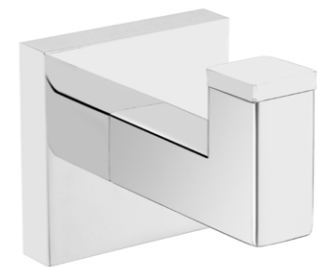

**110200** ●●○  
 Percha 90° AVANT.  
 Acabado: cromo brillo.  
 Material: latón.  
 90° robe hook AVANT.  
 Finish: bright chrome.  
 Material: brass.  
 50 x 48 x 60 mm.



**110300** ●●○  
 Percha recta AVANT.  
 Acabado: cromo brillo.  
 Material: latón.  
 Robe hook AVANT.  
 Finish: bright chrome.  
 Material: brass.  
 48 x 48 x 47 mm.

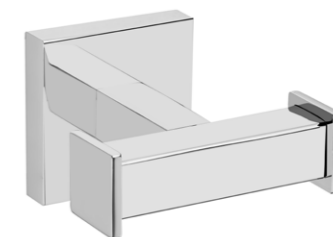

**110100** ●●○  
 Percha doble AVANT.  
 Acabado: cromo brillo.  
 Material: latón.  
 Double robe hook AVANT.  
 Finish: bright chrome.  
 Material: brass.  
 48 x 70 x 65 mm.



**111600** ●●○  
 Portarrollos con tapa AVANT.  
 Acabado: cromo brillo.  
 Material: latón.  
 Toilet roll holder with lid AVANT.  
 Finish: bright chrome.  
 Material: brass.  
 116 x 130 x 60 mm.



**110600** ●●○  
 Portarrollos sin tapa AVANT.  
 Acabado: cromo brillo.  
 Material: latón.  
 Toilet roll holder without lid AVANT.  
 Finish: bright chrome.  
 Material: brass.  
 48 x 165 x 70 mm.



**110500** ●●○  
 Portarrollos reserva AVANT.  
 Acabado: cromo brillo.  
 Material: latón.  
 Reserva toilet roll holder AVANT.  
 Finish: bright chrome.  
 Material: brass.  
 195 x 50 x 85 mm.



**110400** ●●○  
 Portarrollos doble sin tapa AVANT.  
 Acabado: cromo brillo.  
 Material: latón.  
 Double toilet roll holder AVANT.  
 Finish: bright chrome.  
 Material: brass.  
 48 x 250 x 70 mm.

Estructura de dimensiones. alto/ancho/fondo.  
 Dimension structure. height/width/depth.



**110700** ●●○  
Toallero anilla AVANT.  
Acabado: cromo brillo.  
Material: latón.  
Towel ring AVANT.  
Finish: bright chrome.  
Material: brass.  
217 x 200 x 70 mm.



**110800** ●●○  
Toallero barra 30 cm AVANT.  
Acabado: cromo brillo.  
Material: latón.  
Towel bar 30 cm AVANT.  
Finish: bright chrome.  
Material: brass.  
50 x 330 x 75 mm.

**110900** ●●○  
Toallero barra 45 cm AVANT.  
Acabado: cromo brillo.  
Material: latón.  
Towel bar 45 cm AVANT.  
Finish: bright chrome.  
Material: brass.  
50 x 500 x 75 mm.

**111000** ●●○  
Toallero barra 60 cm AVANT.  
Acabado: cromo brillo.  
Material: latón.  
Towel bar 60 cm AVANT.  
Finish: bright chrome.  
Material: brass.  
50 x 630 x 75 mm.



**064202** ●●○  
Esponjera rincón.  
Acabado: cromo brillo.  
Material: acero inoxidable.  
Corner shower basket.  
Finish: bright chrome.  
Material: stainless steel.  
25 x 250 x 180 mm.



**064200** ●●○  
Esponjera rectangular.  
Acabado: cromo brillo.  
Material: acero inoxidable.  
Square shower basket.  
Finish: bright chrome.  
Material: stainless steel.  
50 x 200 x 115 mm.



**064201** ●●○  
Esponjera rectangular hybrid.  
Acabado: cromo brillo.  
Material: acero inoxidable.  
Square hybrid shower basket.  
Finish: bright chrome.  
Material: stainless steel.  
61 x 200 x 110 mm.



**064204-INT-N** ●●○  
Esponjera rincón. int negro  
Acabado: cromo brillo.  
Material: acero inoxidable y ABS.  
Corner shower basket.  
Finish: bright chrome.  
Material: stainless steel and ABS.  
52 x 220 x 220 mm.



**111200** ●●○  
Toallero repisa con barra AVANT.  
Acabado: cromo brillo.  
Material: latón.  
Towel shelf with bar AVANT.  
Finish: bright chrome.  
Material: brass.  
156 x 527 x 255 mm.



**111400** ●●○  
Asa bañera curva plafon cuadrado.  
Acabado: cromo brillo.  
Material: latón.  
Grab rail with square plafon.  
Finish: bright chrome.  
Material: brass.  
120 x 450 x 50 mm.



**111500** ●●○  
Asa bañera curva plafon cuadrado con jabonera.  
Acabado: cromo brillo.  
Material: latón.  
Grab rail with square plafon & shower basket.  
Finish: bright chrome.  
Material: brass.  
120 x 450 x 50 mm.



**064205** ●●○  
Esponjera rectangular.  
Acabado: cromo brillo.  
Material: acero inoxidable y ABS.  
Square shower basket.  
Finish: bright chrome.  
Material: stainless steel and ABS.  
53 x 300 x 124 mm.

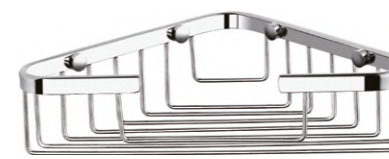

**064001** ●●○  
Esponjera rejilla rincón.  
Acabado: cromo brillo.  
Material: latón.  
Corner shower basket.  
Finish: bright chrome.  
Material: brass.  
63 x 195 x 195 mm.



**064100** ●●○  
Esponjera rejilla rectangular.  
Acabado: cromo brillo.  
Material: latón.  
Rectangular shower basket.  
Finish: bright chrome.  
Material: brass.  
48 x 250 x 123 mm.

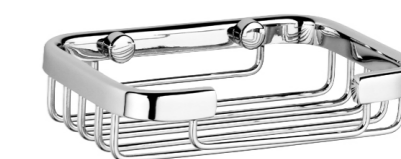

**065101** ●●○  
Esponjera rejilla rectangular pequeña.  
Acabado: cromo brillo.  
Material: latón.  
Small rectangular shower basket.  
Finish: bright chrome.  
Material: brass.  
35 x 132 x 95 mm.



**022500** ●●○

Escobillero pared/suelo cuadrado.  
Acabado: cromo brillo.  
Material: acero inoxidable.  
Square toilet brush holder wall/floor.  
Finish: bright chrome.  
Material: stainless steel.  
386 x 82 x 82 mm.



**062000** ●●○

Escobillero pared/suelo redondo.  
Acabado: cromo brillo.  
Material: acero inoxidable.  
Round toilet brush holder wall/floor.  
Finish: bright chrome.  
Material: stainless steel.  
380 x 96 x 92 mm.



**507700** ●●○

Carro de baño 2 estantes con bandeja metacrilato.  
Acabado: cromo brillo.  
Material: acero inoxidable.  
Bath trolley with 2 shelves & methacrylate tray.  
Finish: bright chrome.  
Material: stainless steel.  
350 x 300 x 450 mm.



**507702** ●●○

Carro de baño 2 estantes con bandeja metacrilato (ancho especial).  
Acabado: cromo brillo.  
Material: acero inoxidable.  
Bath trolley with 2 shelves & methacrylate tray (special width).  
Finish: bright chrome.  
Material: stainless steel.  
600 x 350 x 450 mm.



**062000-SIL** ●

Escobillero pared-suelo inox brillo tapa silicona.  
Acabado: cromo brillo.  
Material: acero inoxidable.  
Toilet brush holder wall/floor.  
Finish: bright chrome.  
Material: stainless steel.  
380 x 96 x 92 mm.



**063001** ●●○

Escobillero pared/suelo redondo abocardado.  
Acabado: cromo brillo.  
Material: acero inoxidable.  
Round toilet brush holder wall/floor.  
Finish: bright chrome.  
Material: stainless steel.  
380 x 96 x 96 mm.



# SFERA

SFERA es una serie de accesorios de baño fabricada en acero inoxidable y cristal arenado. Estos dos materiales crean un juego de texturas combinando la dureza del acero y la delicadeza del cristal. Un diseño que se caracteriza por los volúmenes y los contrastes, haciendo de cada pieza un rincón protagonista.

Esta serie está disponible en varios acabados que ofrecen un sinfín de configuraciones personalizadas y que aportan un toque único de personalidad al espacio.

*SFERA is a series of bathroom accessories made from stainless steel and sandblasted glass. These two materials create a play of textures combining the hardness of steel and the delicacy of glass. A design characterised by volumes and contrasts, making each piece a protagonist corner.*

*This series is available in several finishes that offer an endless number of personalised configurations and bring a unique touch of personality to space.*

Los acabados especiales, cobre cepillado y latón cepillado, cuentan con un recubrimiento PVD (deposición física de vapor), que proporciona una mayor resistencia a la corrosión, asegurando una longevidad superior y manteniendo un aspecto impecable incluso con un uso intensivo.

La serie está disponible en los siguientes acabados:  
Para otros acabados, consultar con equipo comercial.

*The special finishes, brushed copper and brushed brass, feature a PVD (physical vapor deposition) coating, which provides increased corrosion resistance, ensures superior longevity and maintains a flawless appearance even with intensive use.*

*Series available in the following finishes:  
For other finishes, please contact our sales team.*

**Cromo brillo**  
*Bright chrome*



**Negro mate**  
*Matte Black*



**Blanco mate**  
*Matte white*



**Latón cepillado**  
*Brushed brass*



**Cobre cepillado**  
*Brushed copper*



# SFERA

## Cromo brillo

*bright chrome*

**Perchas**  
**Portarrollos**  
**Toalleros**  
**Jaboneras**  
**Escobilleros**

**Hangers**  
**Toilet roll holders**  
**Towel racks**  
**Shower baskets**  
**Toilet brush holders**



**140001** ●●○●●●  
 Percha doble SFERA.  
 Acabado: cromo brillo.  
 Material: zamak y latón.  
 Double robe hook SFERA.  
 Finish: bright chrome.  
 Material: zamak and brass.  
 60 x 115 x 73 mm.

**140008** ●●○●●●  
 Portarrollos con tapa SFERA.  
 Acabado: cromo brillo.  
 Material: zamak y latón.  
 Toilet roll holder with lid SFERA.  
 Finish: bright chrome.  
 Material: zamak and brass.  
 135 x 150 x 160 mm.

**140003** ●●○●●●  
 Portarrollos sin tapa SFERA.  
 Acabado: cromo brillo.  
 Material: zamak y latón.  
 Toilet roll holder without lid SFERA.  
 Finish: bright chrome.  
 Material: zamak and brass.  
 60 x 230 x 76 mm.

**140009** ●●○●●●  
 Portarrollos reserva SFERA.  
 Acabado: cromo brillo.  
 Material: zamak y latón.  
 Reserva toilet roll holder SFERA.  
 Finish: bright chrome.  
 Material: zamak and brass.  
 230 x 60 x 76 mm.



**140002** ●●○●●●  
 Anilla grande SFERA.  
 Acabado: cromo brillo.  
 Material: zamak y latón.  
 Big towel ring SFERA.  
 Finish: bright chrome.  
 Material: zamak and brass.  
 170 x 260 x 80 mm.



**140012** ●●○●●●  
 Anilla pequeña SFERA.  
 Acabado: cromo brillo.  
 Material: zamak y latón.  
 Small towel ring SFERA.  
 Finish: bright chrome.  
 Material: zamak and brass.  
 145 x 220 x 80 mm.

Estructura de dimensiones. alto/ancho/fondo.  
 Dimension structure. height/width/depth.



**140004** ●●○●●  
Toallero barra SFERA 30 cm.  
Acabado: cromo brillo.  
Material: zamak y latón.  
Towel bar SFERA 30 cm.  
Finish: bright chrome.  
Material: zamak and brass.  
60 x 300 x 75 mm.

**140010** ●●○●●  
Toallero barra SFERA 45 cm.  
Acabado: cromo brillo.  
Material: zamak y latón.  
Towel bar SFERA 45 cm.  
Finish: bright chrome.  
Material: zamak and brass.  
60 x 450 x 75 mm.

**140011** ●●○●●  
Toallero barra SFERA 60 cm.  
Acabado: cromo brillo.  
Material: zamak y latón.  
Towel bar SFERA 60 cm.  
Finish: bright chrome.  
Material: zamak and brass.  
60 x 600 x 75 mm.



**064001** ●●○  
Esponjera rejilla rincón.  
Acabado: cromo brillo.  
Material: latón.  
Corner shower basket.  
Finish: bright chrome.  
Material: brass.  
63 x 195 x 195 mm.

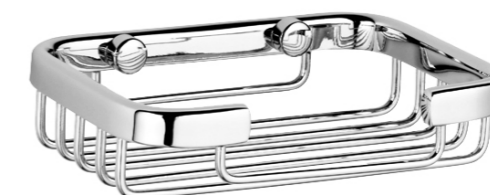

**065101** ●●○  
Esponjera rejilla rectangular pequeña.  
Acabado: cromo brillo.  
Material: latón.  
Small rectangular shower basket.  
Finish: bright chrome.  
Material: brass.  
35 x 132 x 95 mm.



**064100** ●●○  
Esponjera rejilla rectangular.  
Acabado: cromo brillo.  
Material: latón.  
Rectangular shower basket.  
Finish: bright chrome.  
Material: brass.  
48 x 250 x 123 mm.

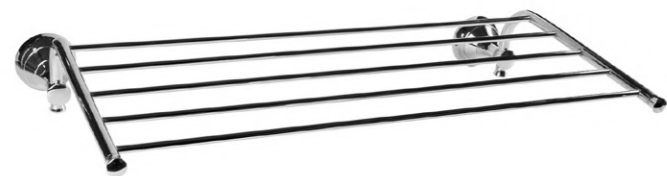

**140007** ●●○●●  
Toallero repisa SFERA.  
Acabado: cromo brillo.  
Material: zamak y latón.  
Towel shelf SFERA.  
Finish: bright chrome.  
Material: zamak and brass.  
130 x 540 x 305 mm.



**140005** ●●○●●  
Dosificador SFERA.  
Acabado: cromo brillo.  
Material: zamak, latón y cristal arenado  
Soap dispenser SFERA.  
Finish: bright chrome.  
Material: zamak, brass and sandblasted glass.  
200 x 160 x 115 mm.



**140006** ●●○●●  
Escobillero SFERA.  
Acabado: cromo brillo.  
Material: zamak, latón y cristal arenado.  
Toilet brush holder SFERA.  
Finish: bright chrome.  
Material: zamak, brass and sandblasted glass.  
365 x 175 x 125 mm.



**063001** ●●○●●  
Escobillero pared/suelo redondo abocardado.  
Acabado: cromo brillo.  
Material: acero inoxidable  
Round toilet brush holder wall/floor.  
Finish: bright chrome.  
Material: stainless steel.  
380 x 96 x 96 mm.

# SFERA negro mate

*matte black*

**Perchas**  
**Portarrollos**  
**Toalleros**  
**Jaboneras**  
**Escobilleros**

**Hangers**  
**Toilet roll holders**  
**Towel racks**  
**Shower baskets**  
**Toilet brush holders**



**140001-N** ●●○●●●  
Percha doble SFERA.  
Acabado: negro mate.  
Material: zamak y latón.  
Double robe hook SFERA.  
Finish: matte black.  
Material: zamak and brass.  
60 x 115 x 73 mm.



**140008-N** ●●○●●●  
Portarrollos con tapa SFERA.  
Acabado: negro mate.  
Material: zamak y latón.  
Toilet roll holder with lid SFERA.  
Finish: matte black.  
Material: zamak and brass.  
135 x 150 x 160 mm.



**140003-N** ●●○●●●  
Portarrollos sin tapa SFERA.  
Acabado: negro mate.  
Material: zamak y latón.  
Toilet roll holder without lid SFERA.  
Finish: matte black.  
Material: zamak and brass.  
60 x 230 x 76 mm.



**140009-N** ●●○●●●  
Portarrollos reserva SFERA.  
Acabado: negro mate.  
Material: zamak y latón.  
Reserva toilet roll holder SFERA.  
Finish: matte black.  
Material: zamak and brass.  
230 x 60 x 76 mm.



**140002-N** ●●○●●●  
Anilla grande SFERA.  
Acabado: negro mate.  
Material: zamak y latón.  
Big towel ring SFERA.  
Finish: matte black.  
Material: zamak and brass.  
170 x 260 x 80 mm.



**140012-N** ●●○●●●  
Anilla pequeña SFERA.  
Acabado: negro mate.  
Material: zamak y latón.  
Small towel ring SFERA.  
Finish: matte black.  
Material: zamak and brass.  
145 x 220 x 80 mm.

Estructura de dimensiones. alto/ancho/fondo.  
Dimension structure. height/width/depth.



**140004-N** ●●○○●●  
Toallero barra SFERA 30 cm.  
Acabado: negro mate.  
Material: zamak y latón.  
Towel bar SFERA 30 cm.  
Finish: matte black.  
Material: zamak and brass.  
60 x 300 x 75 mm.

**140010-N** ●●○○●●  
Toallero barra SFERA 45 cm.  
Acabado: negro mate.  
Material: zamak y latón.  
Towel bar SFERA 45 cm.  
Finish: matte black.  
Material: zamak and brass.  
60 x 450 x 75 mm.

**140011-N** ●●○○●●  
Toallero barra SFERA 60 cm.  
Acabado: negro mate.  
Material: zamak y latón.  
Towel bar SFERA 60 cm.  
Finish: matte black.  
Material: zamak and brass.  
60 x 600 x 75 mm.



**064001-N** ●●○○  
Esponjera rejilla rincón.  
Acabado: negro mate.  
Material: latón.  
Corner shower basket.  
Finish: matte black.  
Material: brass.  
63 x 195 x 195 mm.



**065101-N** ●●○○  
Esponjera rejilla rectangular pequeña.  
Acabado: negro mate.  
Material: latón.  
Small rectangular shower basket.  
Finish: matte black.  
Material: brass.  
35 x 132 x 95 mm.



**064100-N** ●●○○  
Esponjera rejilla rectangular.  
Acabado: negro mate.  
Material: latón.  
Rectangular shower basket.  
Finish: matte black.  
Material: brass.  
48 x 250 x 123 mm.



**140007-N** ●●○○●●  
Toallero repisa SFERA.  
Acabado: negro mate.  
Material: zamak y latón.  
Towel shelf SFERA.  
Finish: matte black.  
Material: zamak and brass.  
130 x 540 x 305 mm.



**140005-N** ●●○○●●  
Dosificador SFERA.  
Acabado: negro mate.  
Material: zamak, latón y cristal arenado.  
Soap dispenser SFERA.  
Finish: matte black.  
Material: stainless steel and sandblasted glass.  
200 x 160 x 115 mm.



**140006-N** ●●○○●●  
Escobillero SFERA.  
Acabado: negro mate.  
Material: zamak, latón y cristal arenado.  
Toilet brush holder SFERA.  
Finish: matte black.  
Material: stainless steel and sandblasted glass.  
365 x 175 x 125 mm.



**063001-N** ●●○○●●  
Escobillero pared/suelo redondo abocardado.  
Acabado: negro mate.  
Material: acero inoxidable.  
Round toilet brush holder wall/floor.  
Finish: matte black.  
Material: stainless steel.  
380 x 96 x 96 mm.

# CARROS

*trolleys*



### 507700

Carro de baño 2 estantes con bandeja metacrilato.  
Acabado: cromo brillo.  
Material: acero inoxidable.  
Bath trolley with 2 shelves & methacrylate tray.  
Finish: bright chrome.  
Material: stainless steel.  
350 x 300 x 450 mm.

Estructura de dimensiones. alto/ancho/fondo.  
Dimension structure. height/width/depth.



### 507702

Carro de baño 2 estantes con bandeja metacrilato (ancho especial).  
Acabado: cromo brillo.  
Material: acero inoxidable.  
Bath trolley with 2 shelves & methacrylate tray (special width).  
Finish: bright chrome.  
Material: stainless steel.  
600 x 350 x 450 mm.



**507700-N**

Carro de baño 2 estantes con bandeja metacrilato.  
Acabado: negro mate.  
Material: acero inoxidable.  
Bath trolley with 2 shelves & methacrylate tray.  
Finish: matte black.  
Material: stainless steel.  
350 x 300 x 450 mm.



**507702-N**

Carro de baño 2 estantes con bandeja metacrilato (ancho especial).  
Acabado: negro mate.  
Material: acero inoxidable.  
Bath trolley with 2 shelves & methacrylate tray (special width).  
Finish: matte black.  
Material: stainless steel.  
600 x 350 x 450 mm.



**507701**

Carro de baño 2 estantes con bandejas cristal.  
Acabado: cromo brillo.  
Material: acero inoxidable.  
Bath trolley with 2 shelves & glass tray.  
Finish: bright chrome.  
Material: stainless steel.  
480 x 350 x 300 mm.



**507701-LC**

Carro de baño 2 estantes con bandejas cristal.  
Acabado: latón cepillado.  
Material: acero inoxidable.  
Bath trolley with 2 shelves & glass tray.  
Finish: brushed brass.  
Material: stainless steel.  
480 x 350 x 300 mm.



**507701-CC**

Carro de baño 2 estantes con bandejas cristal.  
Acabado: cobre cepillado.  
Material: acero inoxidable.  
Bath trolley with 2 shelves & glass tray.  
Finish: brushed copper.  
Material: stainless steel.  
480 x 350 x 300 mm.

# REPISAS

## shelves



### 171601-N

Toallero repisa lavabo 40 cm TEKNO.  
Acabado: negro mate.  
Material: metacrilato.  
Towel shelf washbasin 40 cm TEKNO.  
Finish: matte black.  
Material: methacrylate.  
40 x 400 x 153 mm.



### 171701-N

Toallero repisa lavabo 50 cm TEKNO.  
Acabado: negro mate.  
Material: metacrilato.  
Towel shelf washbasin 50 cm TEKNO.  
Finish: matte black.  
Material: methacrylate.  
40 x 500 x 153 mm.

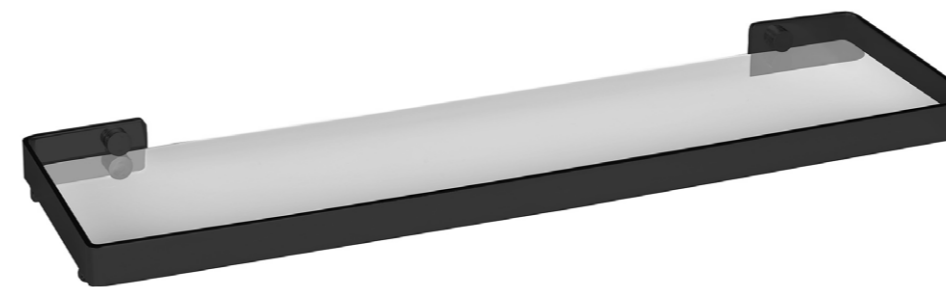

### 131001-N

Repisa 45 cm cristal.  
Acabado: negro mate.  
Material: cristal y acero inoxidable.  
Glass shelf 45 cm.  
Finish: matte black.  
Material: glass & stainless steel.  
20 x 450 x 130 mm.

Estructura de dimensiones. alto/ancho/fondo.  
Dimension structure. height/width/depth.



**181101-N**

Repisa 30 cm TEKNO.  
Acabado: negro mate.  
Material: metacrilato.  
Shelf 30 cm TEKNO.  
Finish: matte black.  
Material: methacrylate.  
40 x 300 x 130 mm.

**181201-N**

Repisa 40 cm TEKNO.  
Acabado: negro mate.  
Material: metacrilato.  
Shelf 30 cm TEKNO.  
Finish: matte black.  
Material: methacrylate.  
40 x 400 x 130 mm.

**181301-N**

Repisa 50 cm TEKNO.  
Acabado: negro mate.  
Material: metacrilato.  
Shelf 30 cm TEKNO.  
Finish: matte black.  
Material: methacrylate.  
40 x 500 x 130 mm.

**181401-N**

Repisa 80 cm TEKNO.  
Acabado: negro mate.  
Material: metacrilato.  
Shelf 30 cm TEKNO.  
Finish: matte black.  
Material: methacrylate.  
40 x 800 x 130 mm.



# EL ACERO INOXIDABLE - AISI 304



**Funde a 1400°**  
*It melts at 1400°*

**Buena durabilidad**  
*Good durability*

**Excelente soldadura**  
*Excellent weldability*



**Corrosión**  
*Corrosion*

**Alta resistencia a la corrosión**  
*High corrosion resistance*

**Uso en baños y entornos húmedos**  
*Use in bathrooms and wet environments*

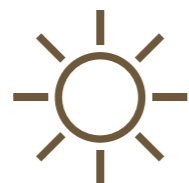

**Resistencia**  
*Resistance*

**No se altera con cambios de temperatura**  
*Does not alter with temperature changes*

**Resistencia a agentes químicos**  
*Resistance to chemical agents*



**Sostenibilidad**  
*Sustainability*

**Reciclable y reutilizable**  
*Recyclable and reusable*

**Residuos seleccionables y fundibles de nuevo**  
*Selectable and re-meltable waste*

## Acabados especiales - *Special finishes*

**Níquel envejecido**  
*Old nickel*

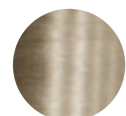

**Latonado antiguo**  
*Antique brass*



**Latón envejecido**  
*Old brass*



**Latón cepillado**  
*Brushed brass*

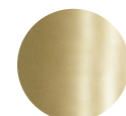

**Cobre envejecido**  
*Old copper*



**Cobre cepillado**  
*Brushed copper*



# Acc. baño en acero inoxidable

## *Stainless steel bathroom accessories*



L I N E R 127

N O R M A X 141

M I N O X 151

R E P I S A S 158

C U B O S 164

LINER es una serie fabricada en acero inoxidable con formas planas y lisas. Esta serie está fabricada con una chapa de 20 mm de ancho y 3 mm de espesor. Disponible en versión de acero inoxidable brillante y en una moderna versión en negro mate que añade un toque de elegancia a cualquier habitación.

# LINER

ACC. ACERO INOX  
STAINLESS STEEL ACC.

*LINER is a series made of stainless steel with flat and smooth shapes. This series is manufactured with a 20 mm wide and 3 mm thick plate. Available in a gloss stainless steel version and in a trendy matt black version that adds a touch of elegance to any room.*

La serie está disponible en los siguientes acabados:  
Para otros acabados, consultar con equipo comercial.

*Series available in the following finishes:  
For other finishes, please contact our sales team.*

**Inox brillo**  
*Bright Inox*

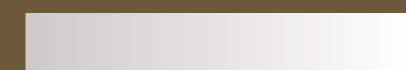

**Satinado**  
*Satin*



**Negro mate**  
*Matte Black*

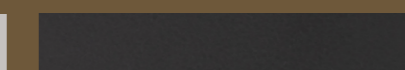

**Blanco mate**  
*Matte white*



# LINER

## chromo brillo

*bright chrome*

**Perchas**  
**Portarrollos**  
**Toalleros**  
**Repisas**  
**Asas**  
**Esponjeras**  
**Escobilleros**

**Hangers**  
**Toilet roll holders**  
**Towel racks**  
**Towel shelves**  
**Grab rails**  
**Shower baskets**  
**Toilet brush holders**

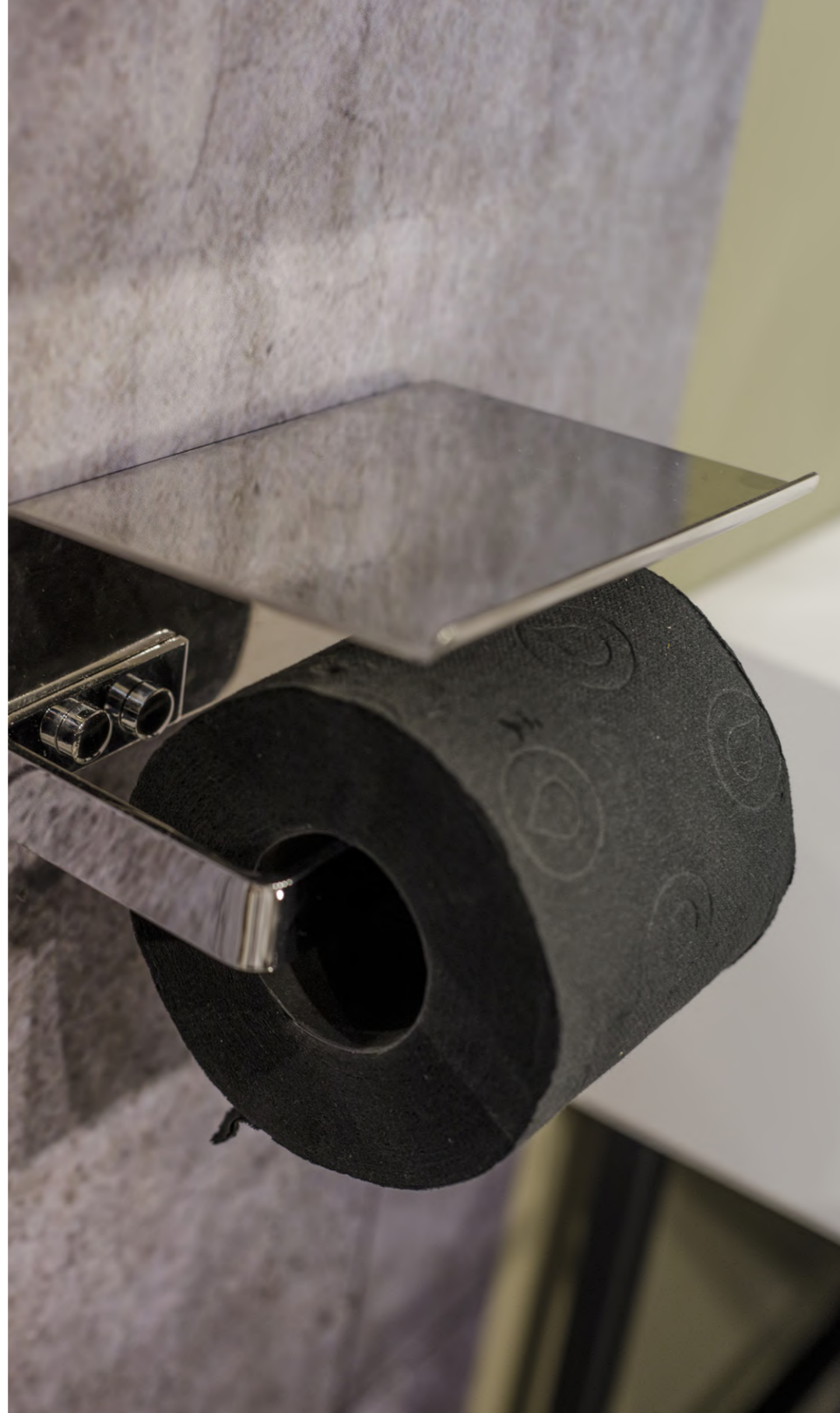

### 130001/130002

Percha 90° LINER.  
 Acabado: inox brillo/satinado.  
 Material: acero inoxidable.  
 90° robe hook LINER.  
 Finish: bright/satin.  
 Material: stainless steel.  
 60 x 20 x 52 mm.



### 131801/131802

Percha recta LINER.  
 Acabado: inox brillo/satinado.  
 Material: acero inoxidable.  
 Robe hook LINER.  
 Finish: bright/satin.  
 Material: stainless steel.  
 60 x 45 x 20 mm.



### 131101/131102

Percha doble LINER.  
 Acabado: inox brillo/satinado.  
 Material: acero inoxidable.  
 Double robe hook LINER.  
 Finish: bright/satin.  
 Material: stainless steel.  
 60 x 70 x 65 mm.



### 131201/131202

Portarrollos con tapa LINER.  
 Acabado: inox brillo/satinado.  
 Material: acero inoxidable.  
 Toilet roll holder with lid LINER.  
 Finish: bright/satin.  
 Material: stainless steel.  
 70 x 140 x 120 mm.



### 131701/131702

Portarrollos con tapa soporte móvil LINER.  
 Acabado: inox brillo/satinado.  
 Material: acero inoxidable.  
 Toilet roll holder with lid for mobile LINER.  
 Finish: bright/satin.  
 Material: stainless steel.  
 75 x 140 x 110 mm.



### 130101/130102

Portarrollos sin tapa LINER.  
 Acabado: inox brillo/satinado.  
 Material: acero inoxidable.  
 Toilet roll holder without lid LINER.  
 Finish: bright/satin.  
 Material: stainless steel.  
 20 x 135 x 75 mm.



### 131501/131502

Portarrollos reserva LINER.  
 Acabado: inox brillo/satinado.  
 Material: acero inoxidable.  
 Reserva toilet roll holder LINER.  
 Finish: bright/satin.  
 Material: stainless steel.  
 135 x 20 x 70 mm.

Estructura de dimensiones. alto/ancho/fondo.  
 Dimension structure. height/width/depth.

**131301/131302**

Toallero bidé LINER.  
 Acabado: inox brillo/satinado.  
 Material: acero inoxidable.  
 Bidet towel rail LINER  
 Finish: bright/satin.  
 Material: stainless steel.  
 20 x 218 x 64 mm.

**130201/130202**

Toallero barra 30 cm LINER.  
 Acabado: inox brillo/satinado.  
 Material: acero inoxidable.  
 Towel bar 30 cm LINER.  
 Finish: bright/satin.  
 Material: stainless steel.  
 20 x 300 x 60 mm.

**130301/130302**

Toallero barra 40 cm LINER.  
 Acabado: inox brillo/satinado.  
 Material: acero inoxidable.  
 Towel bar 40 cm LINER.  
 Finish: bright/satin.  
 Material: stainless steel.  
 20 x 400 x 60 mm.

**131001/131002**

Repisa con cristal LINER.  
 Acabado: inox brillo/satinado.  
 Material: cristal & acero inoxidable.  
 Glass shelf 45 cm LINER.  
 Finish: bright/satin.  
 Material: glass & stainless steel.  
 20 x 450 x 130 mm.

**130901/130902**

Toallero repisa con barra LINER.  
 Acabado: inox brillo/satinado.  
 Material: acero inoxidable.  
 Towel shelf with bar LINER.  
 Finish: bright/satin.  
 Material: stainless steel.  
 100 x 505 x 255 mm.

**130401/130402**

Toallero barra 50 cm LINER.  
 Acabado: inox brillo/satinado.  
 Material: acero inoxidable.  
 Towel bar 50 cm LINER.  
 Finish: bright/satin.  
 Material: stainless steel.  
 20 x 500 x 60 mm.

**130501/130502**

Toallero barra 60 cm LINER.  
 Acabado: inox brillo/satinado.  
 Material: acero inoxidable.  
 Towel bar 60 cm LINER.  
 Finish: bright/satin.  
 Material: stainless steel.  
 20 x 600 x 60 mm.

**021200/021202**

Asa bañera curva.  
 Acabado: inox brillo/satinado.  
 Material: acero inoxidable.  
 Grab rail.  
 Finish: bright/satin.  
 Material: stainless steel.  
 125 x 455 x 85 mm.

**021300/021302**

Asa bañera curva con jabonera.  
 Acabado: inox brillo/satinado.  
 Material: acero inoxidable.  
 Grab rail with shower basket.  
 Finish: bright/satin.  
 Material: stainless steel.  
 165 x 510 x 120 mm.

**020300-A/020302-A**

Asa bañera recta 30 cm.  
 Acabado: inox brillo/satinado.  
 Material: acero inoxidable.  
 Grab rail 30 cm.  
 Finish: bright/satin.  
 Material: stainless steel.  
 45 x 300 x 85 mm.

**130701/130702**

Esponjera rejilla triangular LINER.  
 Acabado: inox brillo/satinado.  
 Material: acero inoxidable.  
 Corner shower basket LINER.  
 Finish: bright/satin.  
 Material: stainless steel.  
 20 x 255 x 135 mm.

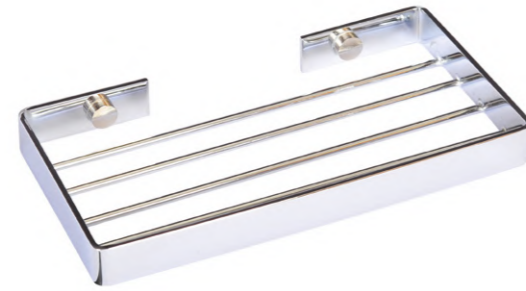
**130601/130602**

Esponjera rejilla rectangular LINER.  
 Acabado: inox brillo/satinado.  
 Material: acero inoxidable.  
 Square shower basket LINER.  
 Finish: bright/satin.  
 Material: stainless steel.  
 20 x 195 x 105 mm.

**130601-AR**

Esponjera rectangular rejilla LINER.  
 Acabado: inox brillo.  
 Material: acero inoxidable.  
 Square shower basket LINER.  
 Finish: bright.  
 Material: stainless steel.  
 75 x 210 x 110 mm.

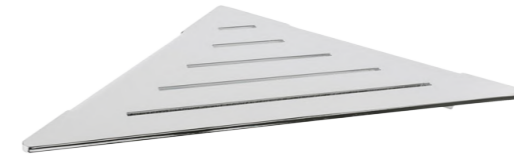
**064202**

Esponjera rincón.  
 Acabado: inox brillo.  
 Material: acero inoxidable.  
 Corner shower basket.  
 Finish: bright.  
 Material: stainless steel.  
 25 x 250 x 180 mm.

**064200**

Esponjera rectangular.  
 Acabado: inox brillo.  
 Material: acero inoxidable.  
 Square shower basket.  
 Finish: bright.  
 Material: stainless steel.  
 50 x 200 x 115 mm.

**064201**

Esponjera rectangular hybrid.  
 Acabado: inox brillo.  
 Material: acero inoxidable.  
 Square hybrid shower basket.  
 Finish: bright.  
 Material: stainless steel.  
 61 x 200 x 110 mm.

**064204-INT-N**

Esponjera rincón.  
 Acabado: inox brillo.  
 Material: acero inoxidable y ABS.  
 Corner metro shower basket.  
 Finish: bright.  
 Material: stainless steel and ABS.  
 52 x 220 x 220 mm.

**064205**

Esponjera rectangular.  
 Acabado: inox brillo.  
 Material: acero inoxidable y ABS.  
 Square metro shower basket.  
 Finish: bright.  
 Material: stainless steel and ABS.  
 53 x 300 x 124 mm.

**062000/062002**

Escobillero pared/suelo redondo.  
 Acabado: inox brillo/satinado.  
 Material: acero inoxidable.  
 Round toilet brush holder wall/floor.  
 Finish: bright/satin.  
 Material: stainless steel.  
 380 x 96 x 92 mm.

**022500/022502**

Escobillero pared/suelo cuadrado.  
 Acabado: inox brillo/satinado.  
 Material: acero inoxidable.  
 Square toilet brush holder wall/floor.  
 Finish: bright/satin.  
 Material: stainless steel.  
 386 x 82 x 82 mm.

**063001/063002**

Escobillero pared/suelo redondo abocardado.  
 Acabado: inox brillo/satinado.  
 Material: acero inoxidable.  
 Round toilet brush holder wall/floor.  
 Finish: bright/satin.  
 Material: stainless steel.  
 380 x 96 x 96 mm.

# LINER

## negro mate

### *matte black*

**Perchas**  
**Portarrollos**  
**Toalleros**  
**Repisas**  
**Asas**  
**Esponjeras**  
**Escobilleros**

**Hangers**  
**Toilet roll holders**  
**Towel racks**  
**Towel shelves**  
**Grab rails**  
**Shower baskets**  
**Toilet brush holders**



#### **130001-N**

Percha 90° LINER.  
 Acabado: negro mate.  
 Material: acero inoxidable.  
 90° robe hook LINER.  
 Finish: matte black.  
 Material: stainless steel.  
 60 x 20 x 52 mm.



#### **131801-N**

Percha recta LINER.  
 Acabado: negro mate.  
 Material: acero inoxidable.  
 Robe hook LINER.  
 Finish: matte black.  
 Material: stainless steel.  
 60 x 45 x 20 mm.



#### **131101-N**

Percha doble LINER.  
 Acabado: negro mate.  
 Material: acero inoxidable.  
 Double robe hook LINER.  
 Finish: matte black.  
 Material: stainless steel.  
 60 x 70 x 65 mm.



#### **131201-N**

Portarrollos con tapa LINER.  
 Acabado: negro mate.  
 Material: acero inoxidable.  
 Toilet roll holder with lid LINER.  
 Finish: matte black.  
 Material: stainless steel.  
 70 x 140 x 120 mm.



#### **131701-N**

Portarrollos con tapa soporte movil LINER.  
 Acabado: negro mate.  
 Material: acero inoxidable.  
 Toilet roll holder with lid for mobile LINER.  
 Finish: matte black.  
 Material: stainless steel.  
 75 x 140 x 110 mm.



#### **130101-N**

Portarrollos sin tapa LINER.  
 Acabado: negro mate.  
 Material: acero inoxidable.  
 Toilet roll holder without lid LINER.  
 Finish: matte black.  
 Material: stainless steel.  
 20 x 135 x 75 mm.

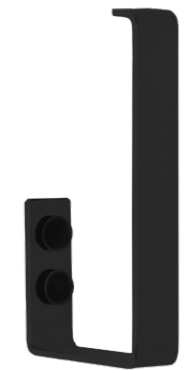

#### **131501-N**

Portarrollos reserva LINER.  
 Acabado: negro mate.  
 Material: acero inoxidable.  
 Reserva toilet roll holder LINER.  
 Finish: matte black.  
 Material: stainless steel.  
 135 x 20 x 70 mm.



**131301-N**  
Toallero bidé LINER.  
Acabado: negro mate.  
Material: acero inoxidable.  
Bidet towel rail LINER.  
Finish: matte black.  
Material: stainless steel.  
20 x 218 x 64 mm.



**130201-N**  
Toallero barra 30 cm LINER.  
Acabado: negro mate.  
Material: acero inoxidable.  
Towel bar 30 cm LINER.  
Finish: matte black.  
Material: stainless steel.  
20 x 300 x 60 mm.



**130301-N**  
Toallero barra 40 cm LINER.  
Acabado: negro mate.  
Material: acero inoxidable.  
Towel bar 40 cm LINER.  
Finish: matte black.  
Material: stainless steel.  
20 x 400 x 60 mm.

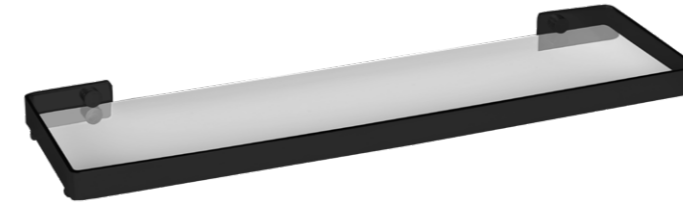

**131001-N**  
Repisa con cristal LINER.  
Acabado: negro mate.  
Material: cristal & acero inoxidable.  
Glass shelf 45 cm LINER.  
Finish: matte black.  
Material: glass & stainless steel.  
20 x 450 x 130 mm.



**130901-N**  
Toallero repisa con barra LINER.  
Acabado: negro mate.  
Material: acero inoxidable.  
Towel shelf with bar LINER.  
Finish: matte black.  
Material: stainless steel.  
100 x 505 x 255 mm.



**130401-N**  
Toallero barra 50 cm LINER.  
Acabado: negro mate.  
Material: acero inoxidable.  
Towel bar 50 cm LINER.  
Finish: matte black.  
Material: stainless steel.  
20 x 500 x 60 mm.



**130501-N**  
Toallero barra 60 cm LINER.  
Acabado: negro mate.  
Material: acero inoxidable.  
Towel bar 60 cm LINER.  
Finish: matte black.  
Material: stainless steel.  
20 x 600 x 60 mm.



**061700-N**  
Asa bañera recta 30 cm.  
Acabado: negro mate.  
Material: latón.  
Grab rail 30 cm.  
Finish: matte black.  
Material: brass.  
45 x 300 x 85 mm.



**061800-N**  
Asa bañera curva.  
Acabado: negro mate.  
Material: latón.  
Grab rail.  
Finish: matte black.  
Material: brass.  
125 x 455 x 85 mm.

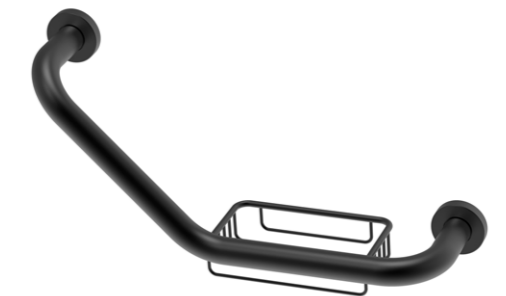

**061900-N**  
Asa bañera curva con jabonera.  
Acabado: negro mate.  
Material: latón.  
Grab rail with shower basket.  
Finish: matte black.  
Material: brass.  
165 x 510 x 120 mm.



**130701-N**  
 Esponjera rejilla triangular LINER.  
 Acabado: negro mate.  
 Material: acero inoxidable.  
 Corner shower basket LINER.  
 Finish: matte black.  
 Material: stainless steel.  
 20 x 255 x 135 mm.

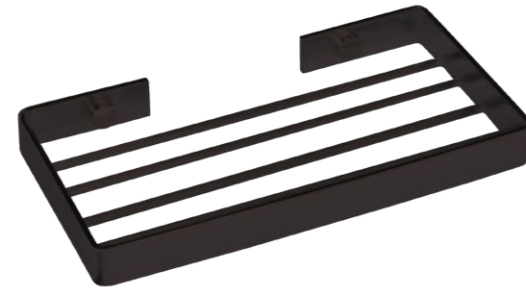

**130601-N**  
 Esponjera rejilla rectangular LINER.  
 Acabado: negro mate.  
 Material: acero inoxidable.  
 Square shower basket LINER.  
 Finish: matte black.  
 Material: stainless steel.  
 20 x 195 x 105 mm.

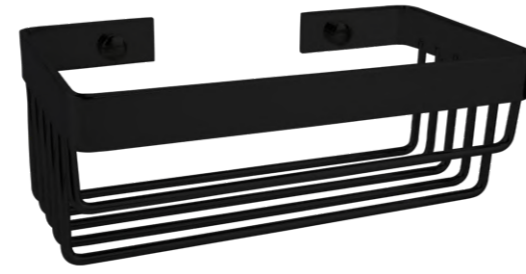

**130601-AR-N**  
 Esponjera rectangular rejilla LINER.  
 Acabado: negro mate.  
 Material: acero inoxidable.  
 Square shower basket LINER.  
 Finish: matte black.  
 Material: stainless steel.  
 75 x 210 x 110 mm.



**064202-N**  
 Esponjera rincón.  
 Acabado: negro mate.  
 Material: acero inoxidable.  
 Corner shower basket.  
 Finish: matte black.  
 Material: stainless steel.  
 25 x 250 x 180 mm.



**064200-N**  
 Esponjera rectangular.  
 Acabado: negro mate.  
 Material: acero inoxidable.  
 Square shower basket.  
 Finish: matte black.  
 Material: stainless steel.  
 50 x 200 x 115 mm.



**064201-N**  
 Esponjera rectangular hybrid.  
 Acabado: negro mate.  
 Material: acero inoxidable.  
 Square hybrid metro shower basket.  
 Finish: matte black.  
 Material: stainless steel.  
 61 x 200 x 110 mm.



**064204-N-N**  
 Esponjera rincón.  
 Acabado: negro mate.  
 Material: acero inoxidable y ABS.  
 Corner metro shower basket.  
 Finish: matte black.  
 Material: stainless steel and ABS.  
 52 x 220 x 220 mm.



**064205-N-N**  
 Esponjera rectangular.  
 Acabado: negro mate.  
 Material: acero inoxidable y ABS.  
 Square metro shower basket.  
 Finish: matte black.  
 Material: stainless steel and ABS.  
 53 x 300 x 124 mm.



**062000-N**  
 Escobillero pared/suelo redondo.  
 Acabado: negro mate.  
 Material: acero inoxidable.  
 Round toilet brush holder wall/floor.  
 Finish: matte black.  
 Material: stainless steel.  
 380 x 96 x 92 mm.



**022500-N**  
 Escobillero pared/suelo cuadrado.  
 Acabado: negro mate.  
 Material: acero inoxidable.  
 Square toilet brush holder wall/floor.  
 Finish: matte black.  
 Material: stainless steel.  
 386 x 82 x 82 mm.



**063001-N**  
 Escobillero pared/suelo redondo abocardado.  
 Acabado: negro mate.  
 Material: acero inoxidable.  
 Round toilet brush holder wall/floor.  
 Finish: matte black.  
 Material: stainless steel.  
 380 x 96 x 96 mm.

NORMAX es una serie fabricada en acero inoxidable de líneas sencillas y redondeadas que transmite equilibrio y encaja en el estilo de decoración de baños minimalistas y modernos. Esta serie está fabricada con un tubo horizontal de 20 mm Ø y anclaje a pared de 14 mm Ø. Disponible en su versión inox brillo y en su versión satinada para adaptarse a cualquier diseño contemporáneo.

# NORMAX

ACC. ACERO INOX  
STAINLESS STEEL ACC.

*NORMAX is a series manufactured in stainless steel with simple, rounded lines that transmits balance and fits in with the decoration style of minimalist and modern bathrooms. This series is manufactured with a horizontal tube of 20 mm Ø and the wall anchoring piece of 14 mm Ø. Available in a bright stainless steel version and in a satin version to adapt to any contemporary design.*

La serie está disponible en los siguientes acabados:  
Para otros acabados, consultar con equipo comercial.

*Series available in the following finishes:  
For other finishes, please contact our sales team.*

**Inox brillo**  
*Bright Inox*



**Satinado**  
*Satin*



**Negro mate**  
*Matte Black*



**Blanco mate**  
*Matte white*



# NORMAX

**Perchas**  
**Portarrollos**  
**Toalleros**  
**Repisas**  
**Asas**  
**Esponjeras**  
**Escobilleros**

**Hangers**  
**Toilet roll holders**  
**Towel racks**  
**Towel shelves**  
**Grab rails**  
**Shower baskets**  
**Toilet brush holders**



### 020100/021002

Percha recta.  
Acabado: inox brillo/satinado.  
Material: acero inoxidable.  
Robe hook.  
Finish: bright/satin.  
Material: stainless steel.  
46 x 46 x 50 mm.



### 030100/030102

Percha recta sin base.  
Acabado: inox brillo/satinado.  
Material: acero inoxidable.  
Robe hook without base.  
Finish: bright/satin.  
Material: stainless steel.  
25 x 25 x 42 mm.



### 031100/031102

Percha recta doble.  
Acabado: inox brillo/satinado.  
Material: acero inoxidable.  
Double robe hook.  
Finish: bright/satin.  
Material: stainless steel.  
45 x 95 x 90 mm.



### 022000/022002

Percha doble.  
Acabado: inox brillo/satinado.  
Material: acero inoxidable.  
Double hook inox.  
Finish: bright/satin.  
Material: stainless steel.  
45 x 100 x 75 mm.

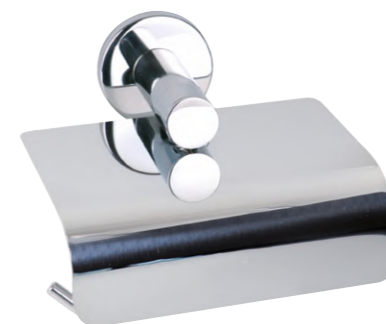

### 020800/020802

Portarrollos con tapa.  
Acabado: inox brillo/satinado.  
Material: acero inoxidable.  
Toilet roll holder with lid.  
Finish: bright/satin.  
Material: stainless steel.  
92 x 140 x 162 mm.



### 021500/021502

Portarrollos elevable.  
Acabado: inox brillo/satinado.  
Material: acero inoxidable.  
Toilet roll holder with flap.  
Finish: bright/satin.  
Material: stainless steel.  
60 x 130 x 125 mm.



### 021400/021402

Portarrollos doble.  
Acabado: inox brillo/satinado.  
Material: acero inoxidable.  
Double toilet roll holder.  
Finish: bright/satin.  
Material: stainless steel.  
80 x 230 x 130 mm.

Estructura de dimensiones. alto/ancho/fondo.  
Dimension structure. height/width/depth.

**030300/030302**

Portarrollos sin tapa.  
Acabado: inox brillo/satinado.  
Material: acero inoxidable.  
Toilet roll holder without lid.  
Finish: bright/satin.  
Material: stainless steel.  
46 x 155 x 80 mm.

**030900/030902**

Portarrollos reserva.  
Acabado: inox brillo/satinado.  
Material: acero inoxidable.  
Reserva toilet roll holder.  
Finish: bright/satin.  
Material: stainless steel.  
155 x 48 x 80 mm.

**031000/031002**

Portarrollos doble sin tapa.  
Acabado: inox brillo/satinado.  
Material: acero inoxidable.  
Double toilet roll holder without lid.  
Finish: bright/satin.  
Material: stainless steel.  
45 x 250 x 90 mm.

**020700/020702**

Toallero anilla.  
Acabado: inox brillo/satinado.  
Material: acero inoxidable.  
Towel ring.  
Finish: bright/satin.  
Material: stainless steel.  
215 x 210 x 70 mm.

**020700-A/020702-A**

Toallero anilla abierta.  
Acabado: inox brillo/satinado.  
Material: acero inoxidable.  
Ring towel inox bright  
Finish: bright/satin.  
Material: stainless steel.  
154 x 182 x 70 mm.

**031200/031202**

Toallero doble barra NORMAX.  
Acabado: inox brillo/satinado.  
Material: acero inoxidable.  
Double towel bar NORMAX.  
Finish: bright/satin.  
Material: stainless steel.  
45 x 526 x 135 mm.

**030500/030502**

Toallero barra 30 cm.  
Acabado: inox brillo/satinado.  
Material: acero inoxidable.  
Towel bar 30 cm.  
Finish: bright/satin.  
Material: stainless steel.  
45 x 300 x 85 mm.

**030600/030602**

Toallero barra 45 cm.  
Acabado: inox brillo/satinado.  
Material: acero inoxidable.  
Towel bar 45 cm.  
Finish: bright/satin.  
Material: stainless steel.  
45 x 450 x 85 mm.

**030700/030702**

Toallero barra 60 cm.  
Acabado: inox brillo/satinado.  
Material: acero inoxidable.  
Towel bar 60 cm.  
Finish: bright/satin.  
Material: stainless steel.  
45 x 600 x 85 mm.

**030800/030802**

Toallero barra 90 cm.  
Acabado: inox brillo/satinado.  
Material: acero inoxidable.  
Towel bar 90 cm.  
Finish: bright/satin.  
Material: stainless steel.  
45 x 900 x 85 mm.

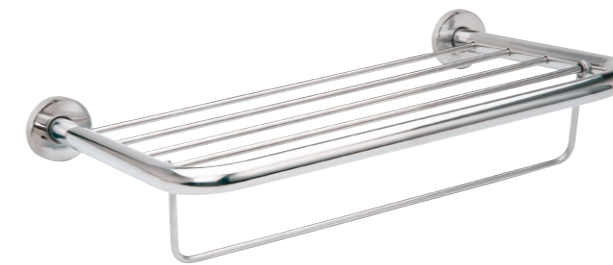
**021000/021002**

Toallero repisa 50 cm con barra.  
Acabado: inox brillo/satinado.  
Material: acero inoxidable.  
Towel shelf with bar 50 cm.  
Finish: bright/satin.  
Material: stainless steel.  
115 x 525 x 275 mm.

**021100/021102**

Toallero repisa 50 cm.  
Acabado: inox brillo/satinado.  
Material: acero inoxidable.  
Towel shelf 50 cm.  
Finish: bright/satin.  
Material: stainless steel.  
45 x 525 x 275 mm.

**021000-P/021002-P**

Toallero repisa 50 cm 4 anclajes con barra.  
Acabado: inox brillo/satinado.  
Material: acero inoxidable.  
Towel shelf with 4 anchors and single towel rail 50 cm.  
Finish: bright/satin.  
Material: stainless steel.  
140 x 525 x 275 mm.

**022400/022402**

Toallero repisa 50 cm 4 anclajes con barra y perchas laterales.  
Acabado: inox brillo/satinado.  
Material: acero inoxidable.  
Towel shelf with 4 anchors, towel bar and side hooks 50 cm.  
Finish: bright/satin.  
Material: stainless steel.  
150 x 505 x 270 mm.

**021600/021602**

Repisa cristal.  
Acabado: inox brillo/satinado.  
Material: acero inoxidable.  
Glass shelf.  
Finish: bright/satin.  
Material: stainless steel.  
45 x 525 x 115 mm.

**021200/021202**

Asa bañera curva.  
Acabado: inox brillo/satinado.  
Material: acero inoxidable.  
Grab rail.  
Finish: bright/satin.  
Material: stainless steel.  
125 x 455 x 85 mm.

**021300/021302**

Asa bañera curva con jabonera.  
Acabado: inox brillo/satinado.  
Material: acero inoxidable.  
Grab rail with shower basket.  
Finish: bright/satin.  
Material: stainless steel.  
165 x 510 x 120 mm.

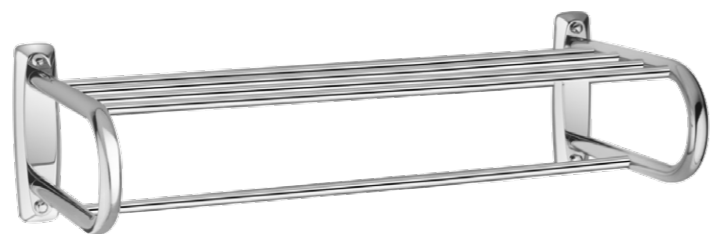
**061501**

Toallero repisa de 50 cm con barra.  
Acabado: cromo brillo.  
Material: acero inoxidable.  
Towel shelf with bar 50 cm.  
Finish: bright chrome.  
Material: stainless steel.  
180 x 510 x 270 mm.

**507801/507802**

Toallero 3 barras NORMAX.  
Acabado: inox brillo/satinado.  
Material: acero inoxidable.  
Towel rail with 3 bars.  
Finish: bright/satin.  
Material: stainless steel.  
490 x 585 x 80 mm.

**064202**

Esponjera rincón.  
Acabado: inox brillo.  
Material: acero inoxidable.  
Corner shower basket.  
Finish: bright.  
Material: stainless steel.  
25 x 250 x 180 mm.

**064200**

Esponjera rectangular.  
Acabado: inox brillo.  
Material: acero inoxidable.  
Square shower basket.  
Finish: bright.  
Material: stainless steel.  
50 x 200 x 115 mm.

**064201**

Esponjera rectangular hybrid.  
Acabado: inox brillo.  
Material: acero inoxidable.  
Square hybrid shower basket.  
Finish: bright.  
Material: stainless steel.  
61 x 200 x 110 mm.



**041600/041602**

Esponjara rincon.  
Acabado: inox brillo/satinado.  
Material: acero inoxidable.  
Corner shower basket.  
Finish: bright/satin.  
Material: stainless steel.  
20 x 250 x 125 mm.



**041800/041802**

Esponjara alargada chapa.  
Acabado: inox brillo/satinado.  
Material: acero inoxidable.  
Shower basket plate.  
Finish: bright/satin.  
Material: stainless steel.  
25 x 200 x 90 mm.



**041700/041702**

Esponjara rectangular chapa.  
Acabado: inox brillo/satinado.  
Material: acero inoxidable.  
Square shower basket plate.  
Finish: bright/satin.  
Material: stainless steel.  
20 x 120 x 90 mm.



**064204-INT-N**

Esponjara rincón.  
Acabado: inox brillo.  
Material: acero inoxidable y ABS.  
Corner shower basket.  
Finish: bright.  
Material: stainless steel and ABS.  
52 x 220 x 220 mm.



**064205**

Esponjara rectangular.  
Acabado: inox brillo.  
Material: acero inoxidable y ABS.  
Square shower basket.  
Finish: bright.  
Material: stainless steel and ABS.  
53 x 300 x 124 mm.



**101200/101202**

Esponjera rejilla pequeña varilla.  
Acabado: inox brillo/satinado.  
Material: acero inoxidable.  
Small shower basket.  
Finish: bright/satin.  
Material: stainless steel.  
37 x 160 x 110 mm.



**101100/101102**

Esponjera rejilla mediana varilla.  
Acabado: inox brillo/satinado.  
Material: acero inoxidable.  
Medium shower basket.  
Finish: bright/satin.  
Material: stainless steel.  
30 x 210 x 110 mm.

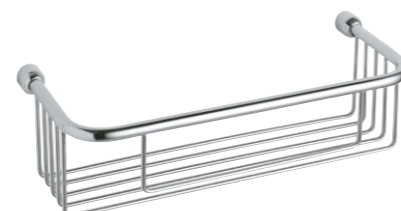

**101000/101002**

Esponjera rejilla grande varilla.  
Acabado: inox brillo/satinado.  
Material: acero inoxidable.  
Big shower basket.  
Finish: bright/satin.  
Material: stainless steel.  
85 x 315 x 125 mm.



**062000/062002**

Escobillero pared/suelo redondo.  
Acabado: inox brillo/satinado.  
Material: acero inoxidable.  
Round toilet brush holder wall/floor.  
Finish: bright/satin.  
Material: stainless steel.  
380 x 96 x 92 mm.



**063001/063002**

Escobillero pared/suelo redondo abocardado.  
Acabado: inox brillo/satinado.  
Material: acero inoxidable.  
Round toilet brush holder wall/floor.  
Finish: bright/satin.  
Material: stainless steel.  
380 x 96 x 96 mm.

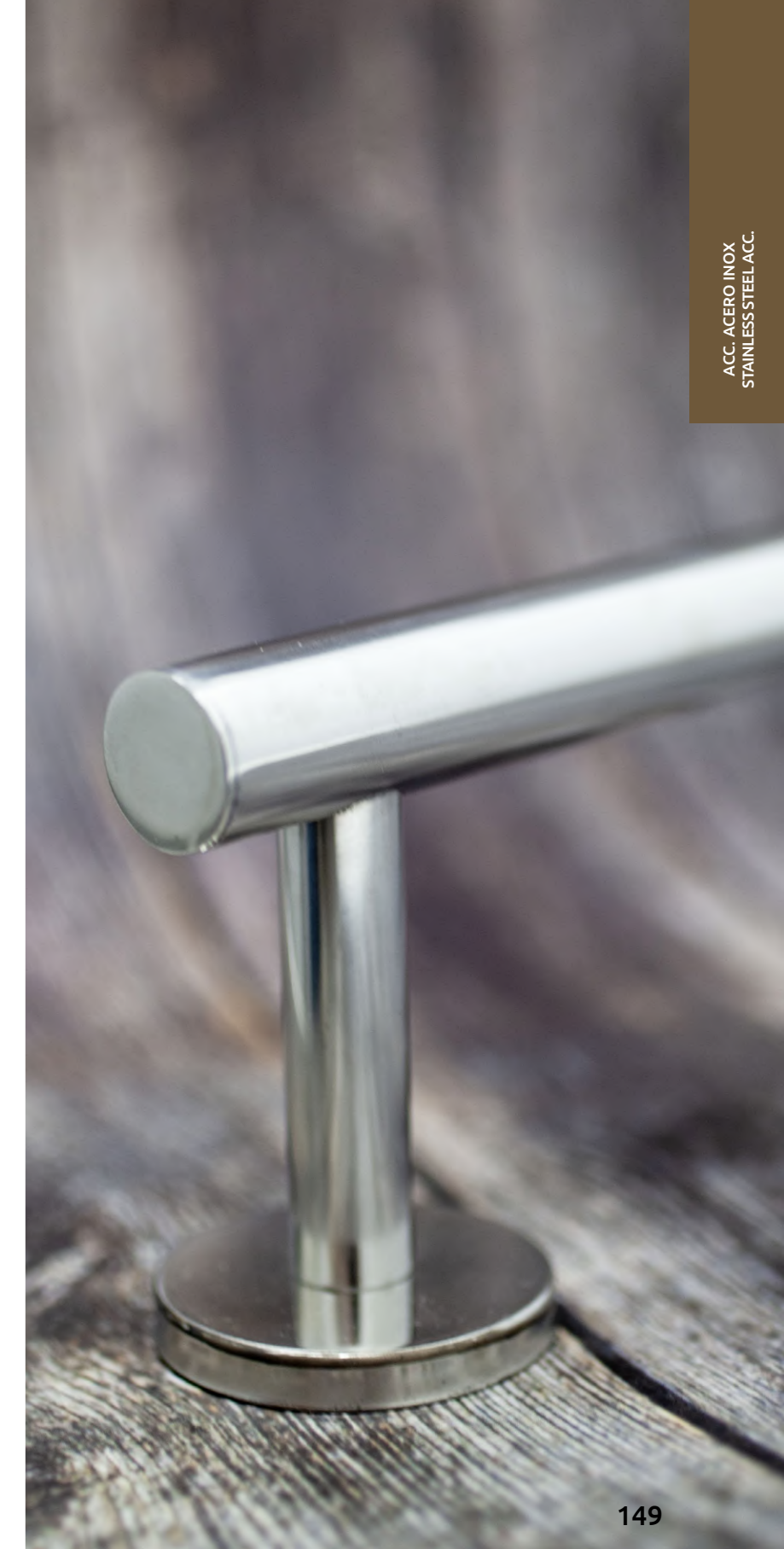

MINOX es una serie fabricada en acero inoxidable 304 de formas cilíndricas que recuerda el estilo industrial. Esta serie está fabricada con un tubo horizontal de 20 mm Ø y anclaje a pared de 10 mm Ø. Disponible en su versión inox brillo y en su versión satinada para combinarse en un baño de estilo industrial.

# MINOX

ACC. ACERO INOX  
STAINLESS STEEL ACC.

*MINOX is a series manufactured in 304 stainless steel with cylindrical shapes reminiscent of the industrial style. This series is manufactured with a horizontal tube of 20 mm Ø and the wall anchoring piece of 10 mm Ø. Available in a gloss stainless steel version and in a satin version to be combined in an industrial style bathroom.*

La serie está disponible en los siguientes acabados:  
Para otros acabados, consultar con equipo comercial.

*Series available in the following finishes:  
For other finishes, please contact our sales team.*

**Inox brillo**  
*Bright Inox*



**Satinado**  
*Satin*



**Negro mate**  
*Matte Black*

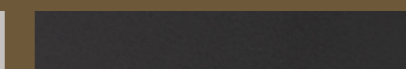

**Blanco mate**  
*Matte white*



# MINOX

**Perchas**  
**Portarrollos**  
**Toalleros**  
**Repisas**  
**Asas**  
**Esponjeras**  
**Escobilleros**

**Hangers**  
**Toilet roll holders**  
**Towel racks**  
**Towel shelves**  
**Grab rails**  
**Shower baskets**  
**Toilet brush holders**



**090100/090102**

Percha recta MINOX.  
Acabado: inox brillo/satinado.  
Material: acero inoxidable.  
Robe hook MINOX.  
Finish: bright/satin.  
Material: stainless steel.  
20 x 20 x 65 mm.



**091100/091102**

Percha doble MINOX.  
Acabado: inox brillo/satinado.  
Material: acero inoxidable.  
Double robe hook MINOX.  
Finish: bright/satin.  
Material: stainless steel.  
20 x 80 x 45 mm.



**091200/091202**

Percha triple MINOX.  
Acabado: inox brillo/satinado.  
Material: acero inoxidable.  
Triple robe hook MINOX.  
Finish: bright/satin.  
Material: stainless steel.  
20 x 140 x 45 mm.



**021500/021502**

Portarrollos elevable.  
Acabado: inox brillo/satinado.  
Material: acero inoxidable.  
Toilet roll holder with flap.  
Finish: bright/satin.  
Material: stainless steel.  
60 x 130 x 125 mm.



**021400/021402**

Portarrollos doble.  
Acabado: inox brillo/satinado.  
Material: acero inoxidable.  
Double toilet roll holder.  
Finish: bright/satin.  
Material: stainless steel.  
80 x 230 x 130 mm.



**090200/090202**

Portarrollos sin tapa MINOX.  
Acabado: inox brillo/satinado.  
Material: acero inoxidable.  
Toilet roll holder without lid  
MINOX.  
Finish: bright/satin.  
Material: stainless steel.  
20 x 20 x 135 mm.



**090300/090302**

Portarrollos 90° sin tapa MINOX.  
Acabado: inox brillo/satinado.  
Material: acero inoxidable.  
90° toilet roll holder without lid  
MINOX.  
Finish: bright/satin.  
Material: stainless steel.  
20 x 160 x 80 mm.



**090900/090902**

Portarrollos reserva MINOX.  
Acabado: inox brillo/satinado.  
Material: acero inoxidable.  
Reserva toilet roll holder MINOX.  
Finish: bright/satin.  
Material: stainless steel.  
160 x 20 x 85 mm.

Estructura de dimensiones. alto/ancho/fondo.  
Dimension structure. height/width/depth.



**090400/090402**

Toallero barra 30 cm MINOX.  
Acabado: inox brillo/satinado.  
Material: acero inoxidable.  
Towel bar 30 cm MINOX.  
Finish: bright/satin.  
Material: stainless steel.  
20 x 330 x 80 mm.

**090500/090502**

Toallero barra 45 cm MINOX.  
Acabado: inox brillo/satinado.  
Material: acero inoxidable.  
Towel bar 45 cm MINOX.  
Finish: bright/satin.  
Material: stainless steel.  
20 x 480 x 80 mm.

**090600/090602**

Toallero barra 60 cm MINOX.  
Acabado: inox brillo/satinado.  
Material: acero inoxidable.  
Towel bar 60 cm MINOX.  
Finish: bright/satin.  
Material: stainless steel.  
20 x 630 x 80 mm.



**020700/020702**

Toallero anilla.  
Acabado: inox brillo/satinado.  
Material: acero inoxidable.  
Towel ring.  
Finish: bright/satin.  
Material: stainless steel.  
215 x 210 x 70



**021000-P/021002-P**

Toallero repisa 50 cm 4 anclajes con barra.  
Acabado: inox brillo/satinado.  
Material: acero inoxidable.  
Towel shelf with 4 anchors and single towel rail 50 cm.  
Finish: bright/satin.  
Material: stainless steel.  
140 x 525 x 275 mm.



**022400/022402**

Toallero repisa 50 cm 4 anclajes con barra y perchas laterales.  
Acabado: inox brillo/satinado.  
Material: acero inoxidable.  
Towel shelf with 4 anchors, towel bar and side hooks 50 cm  
Finish: bright/satin.  
Material: stainless steel.  
150 x 505 x 270 mm.



**021000/021002**

Toallero repisa 50 cm con barra.  
Acabado: inox brillo/satinado.  
Material: acero inoxidable.  
Towel shelf with bar 50 cm.  
Finish: bright/satin.  
Material: stainless steel.  
115 x 525 x 275 mm.



**021100/021102**

Toallero repisa 50 cm.  
Acabado: inox brillo/satinado.  
Material: acero inoxidable.  
Towel shelf 50 cm polished  
Finish: bright/satin.  
Material: stainless steel.  
45 x 525 x 275 mm.



**021200/021202**

Asa bañera curva.  
Acabado: inox brillo/satinado.  
Material: acero inoxidable.  
Grab rail.  
Finish: bright/satin.  
Material: stainless steel.  
125 x 455 x 85 mm.



**021300/021302**

Asa bañera curva con jabonera.  
Acabado: inox brillo/satinado.  
Material: acero inoxidable.  
Grab rail with shower basket.  
Finish: bright/satin.  
Material: stainless steel.  
165 x 510 x 120 mm.



**064204-INT-N**

Esponjera rincón.  
Acabado: inox brillo.  
Material: acero inoxidable y ABS.  
Corner metro shower basket.  
Finish: bright/satin.  
Material: stainless steel and ABS.  
52 x 220 x 220 mm.



**064205**

Esponjera rectangular.  
Acabado: inox brillo.  
Material: acero inoxidable y ABS.  
Square metro shower basket.  
Finish: bright/satin.  
Material: stainless steel and ABS.  
53 x 300 x 124 mm.

**064202**

Esponjera rincón.  
Acabado: inox brillo.  
Material: acero inoxidable.  
Corner shower basket.  
Finish: bright/satin.  
Material: stainless steel.  
25 x 250 x 180 mm.

**064200**

Esponjera rectangular.  
Acabado: inox brillo.  
Material: acero inoxidable.  
Square shower basket.  
Finish: bright/satin.  
Material: stainless steel.  
50 x 200 x 115 mm.

**064201**

Esponjera rectangular hybrid.  
Acabado: inox brillo.  
Material: acero inoxidable.  
Square hybrid shower basket.  
Finish: bright/satin.  
Material: stainless steel.  
61 x 200 x 110 mm.

**101200/101202**

Esponjera rejilla pequeña varilla.  
Acabado: inox brillo/satinado.  
Material: acero inoxidable.  
Small shower basket.  
Finish: bright/satin.  
Material: stainless steel.  
37 x 160 x 110 mm.

**101100/101102**

Esponjera rejilla mediana varilla.  
Acabado: inox brillo/satinado.  
Material: acero inoxidable.  
Medium shower basket.  
Finish: bright/satin.  
Material: stainless steel.  
30 x 210 x 110 mm.

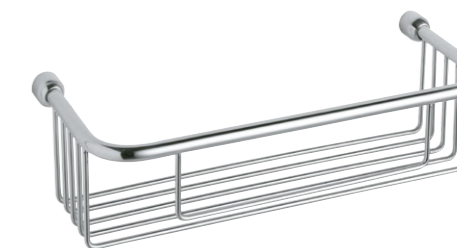
**101000/101002**

Esponjera rejilla grande varilla.  
Acabado: inox brillo/satinado.  
Material: acero inoxidable.  
Big shower basket.  
Finish: bright/satin.  
Material: stainless steel.  
85 x 315 x 125 mm.

**041600/041602**

Esponjera rincon.  
Acabado: inox brillo/satinado.  
Material: acero inoxidable.  
Corner shower basket.  
Finish: bright/satin.  
Material: stainless steel.  
20 x 250 x 125 mm.

**041800/041802**

Esponjera alargada chapa.  
Acabado: inox brillo/satinado.  
Material: acero inoxidable.  
Elongated shower basket plate.  
Finish: bright/satin.  
Material: stainless steel.  
25 x 200 x 90 mm.

**041700/041702**

Esponjera rectangular chapa.  
Acabado: inox brillo/satinado.  
Material: acero inoxidable.  
Square shower basket plate.  
Finish: bright/satin.  
Material: stainless steel.  
20 x 120 x 90 mm.

**062000/062002**

Escobillero pared/suelo redondo.  
Acabado: inox brillo/satinado.  
Material: acero inoxidable.  
Round toilet brush holder wall/floor.  
Finish: bright/satin.  
Material: stainless steel.  
380 x 96 x 92 mm.

**063001/063002**

Escobillero pared/suelo redondo abocardado.  
Acabado: inox brillo/satinado.  
Material: acero inoxidable.  
Round toilet brush holder wall/floor.  
Finish: bright/satin.  
Material: stainless steel.  
380 x 96 x 96 mm.

# REPIAS

## Shelfs

### Repisas lavabo

### Repisas ducha

### Washbasin shelfs

### Shower shelfs

La serie está disponible en los siguientes acabados:  
Para otros acabados, consultar con equipo comercial.

*Series available in the following finishes:  
For other finishes, please contact our sales team.*

**Inox brillo** *Bright Inox*



**Satinado** *Satin*



**Negro mate** *Matte Black*



**Blanco mate** *Matte white*

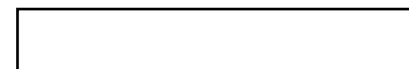

#### 022100-R/022100-R

Repisa metacrilato con pletinas.  
Acabado: inox brillo/satinado.  
Material: acero inoxidable.  
Methacrylate shelf with stainless steel supports.  
Finish: bright/satin.  
Material: stainless steel.  
30 x 450 x 125 mm.



#### 021900/021902

Repisa metacrilato con pletinas.  
Acabado: inox brillo/satinado.  
Material: acero inoxidable.  
Methacrylate shelf with stainless steel supports.  
Finish: bright/satin.  
Material: stainless steel.  
50 x 450 x 135 mm.



#### 022000-R/022002-R

Repisa metacrilato con soportes y barra frontal.  
Acabado: inox brillo/satinado.  
Material: acero inoxidable.  
Methacrylate shelf with supports and frontal bar.  
Finish: bright/satin.  
Material: stainless steel.  
50 x 470 x 135 mm.



#### 021600/021602

Repisa cristal.  
Acabado: inox brillo/satinado.  
Material: acero inoxidable.  
Glass shelf.  
Finish: bright/satin.  
Material: stainless steel.  
45 x 525 x 115 mm.



#### 131001/131002

Repisa con cristal LINER.  
Acabado: inox brillo/satinado.  
Material: cristal & acero inoxidable.  
Glass shelf LINER.  
Finish: bright/satin.  
Material: glass & stainless steel.  
20 x 450 x 130 mm.



#### 131001-N

Repisa con cristal LINER.  
Acabado: negro mate.  
Material: cristal & acero inoxidable.  
Glass shelf LINER.  
Finish: matte black.  
Material: glass & stainless steel.  
20 x 450 x 130 mm.

Estructura de dimensiones. alto/ancho/fondo.  
Dimension structure. height/width/depth.

**507801/507802**

Toallero 3 barras NORMAX.  
 Acabado: inox brillo/satinado.  
 Material: acero inoxidable.  
 Towel rail with 3 bars.  
 Finish: bright/satin.  
 Material: stainless steel.  
 490 x 585 x 80 mm.

**507800/507803**

Toallero 3 barras.  
 Acabado: inox brillo/satinado.  
 Material: acero inoxidable.  
 Towel rail with 3 bars.  
 Finish: bright/satin.  
 Material: stainless steel.  
 510 x 425 x 85 mm.

**130901/130902**

Toallero repisa con barra LINER.  
 Acabado: inox brillo/satinado.  
 Material: acero inoxidable.  
 Towel shelf with bar LINER.  
 Finish: bright/satin.  
 Material: stainless steel.  
 100 x 505 x 255 mm.

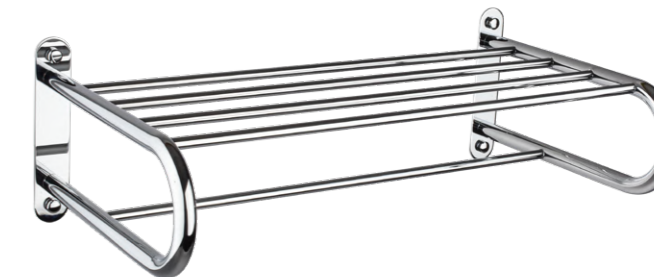
**061500**

Toallero repisa pletinas con barra 4 anclajes NOA 50 cm.  
 Acabado: cromo brillo.  
 Material: latón.  
 Towel shelf with bar 4 anchors NOA 50 cm.  
 Finish: bright chrome.  
 Material: brass.  
 145 x 480 x 260 mm.

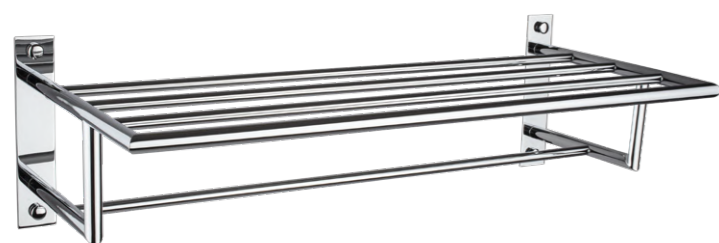
**151200**

Toallero repisa con barra cuatro anclajes METRO 50 cm.  
 Acabado: cromo brillo.  
 Material: latón.  
 Towel shelf with bar four anchors METRO 50 cm.  
 Finish: bright chrome.  
 Material: brass.  
 150 x 530 x 228 mm.

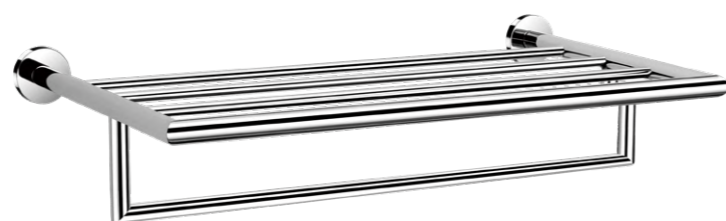
**061311**

Toallero repisa con barra NOA 50 cm.  
 Acabado: cromo brillo.  
 Material: latón.  
 Towel shelf with bar NOA 50 cm.  
 Finish: bright chrome.  
 Material: brass.  
 134 x 552 x 270 mm.

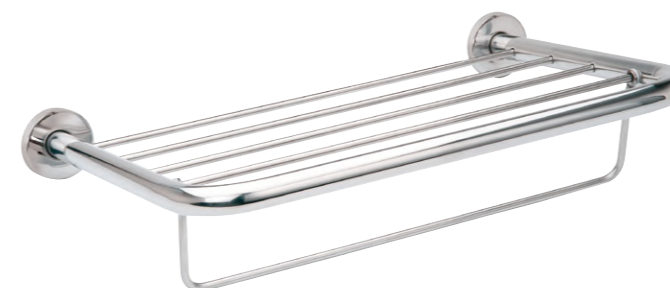
**021000/021002**

Toallero repisa 50 cm con barra.  
 Acabado: inox brillo/satinado.  
 Material: acero inoxidable.  
 Towel shelf with bar 50 cm.  
 Finish: bright/satin.  
 Material: stainless steel.  
 115 x 525 x 275 mm.

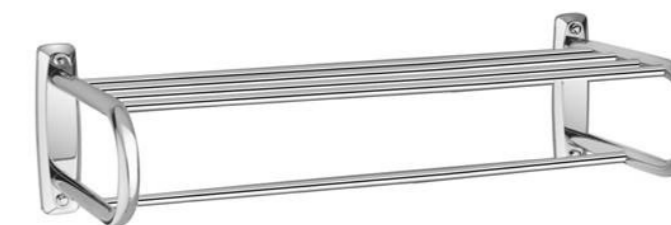
**061501**

Toallero repisa con barra 50 cm.  
 Acabado: cromo brillo.  
 Material: acero inoxidable.  
 Towel shelf with bar 50 cm.  
 Finish: bright chrome.  
 Material: stainless steel.  
 180 x 510 x 270 mm.



**021000-P/021002-P**

Toallero repisa 50 cm 4 anclajes con barra.

Acabado: inox brillo/satinado.

Material: acero inoxidable.

Towel shelf with 4 anchors and single towel rail 50 cm.

Finish: bright/satin.

Material: stainless steel.

140 x 525 x 275 mm.

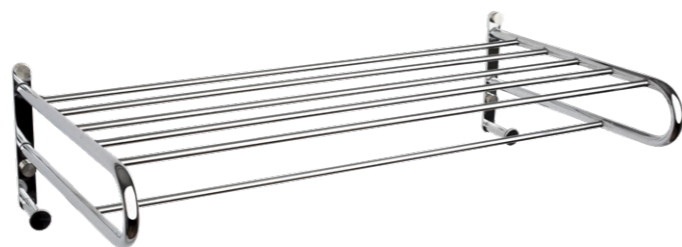

**062600**

Toallero respisa 50 cm 4 anclajes con barra y perchas.

Acabado: inox brillo.

Material: acero inoxidable.

Towel shelf 50 cm 4 anchors with bar and hooks.

Finish: bright.

Material: stainless steel.

140 x 500 x 270 mm.



**022400/022402**

Toallero repisa 50 cm 4 anclajes con barra y perchas laterales.

Acabado: inox brillo/satinado.

Material: acero inoxidable.

Towel shelf with 4 anchors, towel bar and side hooks 50 cm.

Finish: bright/satin.

Material: stainless steel.

150 x 505 x 270 mm.

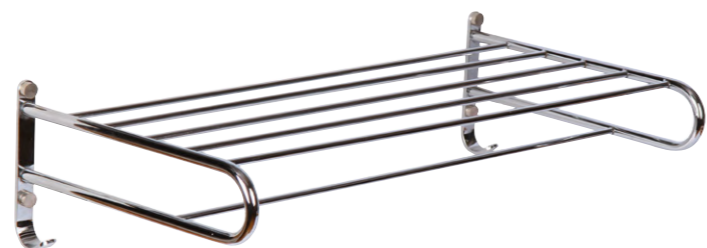

**062700**

Toallero repisa 50 cm 4 anclajes con barra y perchas.

Acabado: inox brillo.

Material: acero inoxidable.

Towel shelf 50 cm 4 anchors with bar and hooks.

Finish: bright.

Material: stainless steel.

135 x 500 x 270 mm.



# CUBOS

## Bins

**3 litros**  
**5 litros**  
**12 litros**

**3 litres**  
**5 litres**  
**12 litres**



**500100**  
Cubo pedal 3L.  
Acabado: inox brillo.  
Material: acero inoxidable.  
Pedal bin 3L.  
Finish: bright.  
Material: stainless steel.  
245 x 170 x 220 mm.



**500103**  
Cubo pedal 3L.  
Acabado: negro mate.  
Material: acero inoxidable.  
Pedal bin 3L.  
Finish: matte black.  
Material: stainless steel.  
245 x 170 x 220 mm.



**500102**  
Cubo pedal 3L.  
Acabado: satinado.  
Material: acero inoxidable.  
Pedal bin 3L.  
Finish: satin.  
Material: stainless steel.  
245 x 170 x 220 mm.



**500108**  
Cubo pedal 3L.  
Acabado: blanco.  
Material: acero inoxidable.  
Pedal bin 3L.  
Finish: white.  
Material: stainless steel.  
245 x 170 x 220 mm.



**500200**  
Cubo pedal 5L.  
Acabado: inox brillo.  
Material: acero inoxidable.  
Pedal bin 5L.  
Finish: bright.  
Material: stainless steel.  
280 x 205 x 255 mm.



**500200-N**  
Cubo pedal 5L.  
Acabado: negro mate.  
Material: acero inoxidable.  
Pedal bin 5L.  
Finish: matte black.  
Material: stainless steel.  
280 x 205 x 255 mm.



**500202**  
Cubo pedal 5L.  
Acabado: satinado.  
Material: acero inoxidable.  
Pedal bin 5L.  
Finish: satin.  
Material: stainless steel.  
280 x 205 x 255 mm.



**500208**  
Cubo pedal 5L.  
Acabado: blanco.  
Material: acero inoxidable.  
Pedal bin 5L.  
Finish: white.  
Material: stainless steel.  
280 x 205 x 255 mm.

Estructura de dimensiones. alto/ancho/fondo.  
Dimension structure. height/width/depth.



**500300**  
Cubo pedal 12L.  
Acabado: inox brillo.  
Material: acero inoxidable.  
Pedal bin 12L.  
Finish: bright.  
Material: stainless steel.  
400 x 250 x 300 mm.



**500300-N**  
Cubo pedal 12L.  
Acabado: negro mate.  
Material: acero inoxidable.  
Pedal bin 12L.  
Finish: matte black.  
Material: stainless steel.  
400 x 250 x 300 mm.



**500302**  
Cubo pedal 12L.  
Acabado: satinado.  
Material: acero inoxidable.  
Pedal bin 12L.  
Finish: satin.  
Material: stainless steel.  
400 x 250 x 300 mm.



**500308**  
Cubo pedal 12L.  
Acabado: blanco.  
Material: acero inoxidable.  
Pedal bin 12L.  
Finish: white.  
Material: stainless steel.  
400 x 250 x 300 mm.



**500300BN**  
Cubo pedal newicon 12L.  
Acabado: inox brillo.  
Material: acero inoxidable.  
Pedal bin newicon 12L.  
Finish: bright.  
Material: stainless steel.  
411 x 338 x 251 mm.



**500300BN-N**  
Cubo pedal newicon 12L.  
Acabado: negro mate.  
Material: acero inoxidable.  
Pedal bin newicon 12L.  
Finish: matte black.  
Material: stainless steel.  
411 x 338 x 251 mm.



**500302BN**  
Cubo pedal newicon 12L.  
Acabado: satinado.  
Material: acero inoxidable.  
Pedal bin newicon 12L.  
Finish: satin.  
Material: stainless steel.  
411 x 338 x 251 mm.



**500300BN-BL**  
Cubo pedal newicon 12L.  
Acabado: blanco.  
Material: acero inoxidable.  
Pedal bin newicon 12L.  
Finish: white.  
Material: stainless steel.  
411 x 338 x 251 mm.



**500200BN**  
Cubo pedal newicon 5L.  
Acabado: inox brillo.  
Material: acero inoxidable.  
Pedal bin newicon 5L.  
Finish: bright.  
Material: stainless steel.  
291 x 205 x 272 mm.



**500200BN-N**  
Cubo pedal newicon 5L.  
Acabado: negro mate.  
Material: acero inoxidable.  
Pedal bin newicon 5L.  
Finish: matte black.  
Material: stainless steel.  
291 x 205 x 272 mm.



**500202BN**  
Cubo pedal newicon 5L.  
Acabado: satinado.  
Material: acero inoxidable.  
Pedal bin newicon 5L.  
Finish: satin.  
Material: stainless steel.  
291 x 205 x 272 mm.



**500200BN-BL**  
Cubo pedal newicon 5L.  
Acabado: blanco.  
Material: acero inoxidable.  
Pedal bin newicon 5L.  
Finish: white.  
Material: stainless steel.  
291 x 205 x 272 mm.



**500201**  
Cubo pedal decobin 5L.  
Acabado: satinado.  
Material: acero inoxidable.  
Pedal bin decobin 5L.  
Finish: satin.  
Material: stainless steel.  
274 x 246 x 210 mm.



**500203**  
Cubo pedal decobin 20L.  
Acabado: satinado.  
Material: acero inoxidable.  
Pedal bin decobin 20L.  
Finish: satin.  
Material: stainless steel.  
450 x 310 x 310 mm.



## Novedad espejos luz LED / *New LED light mirrors*

### MODELOS FUTURLED:

- Nueva base cuadrada
- 2 modos de luz

### FUTURLED MODELS:

- *New square base*
- *2 light modes*

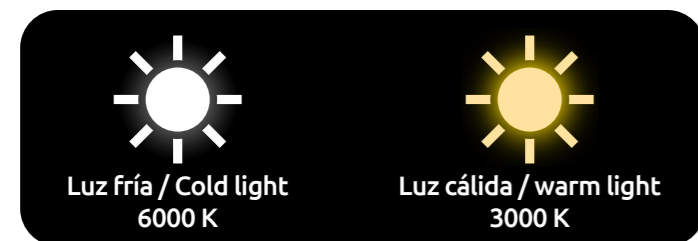

REFs: 200206 - 200206-N - 200205 - 200204

### MODELOS LUXURY:

- Nuevo botón sensor touch
- 2 modos de luz

### LUXURY MODELS:

- *New sensor touch button*
- *2 light modes*

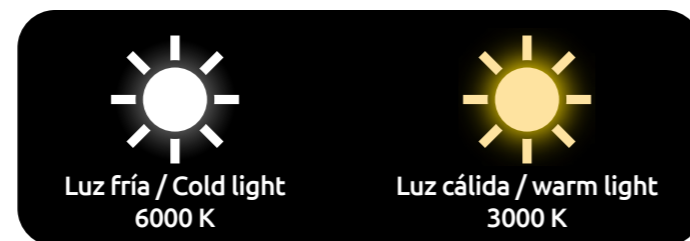

REFs: 200104-NV - 200104-NV-N

### MODELOS DIVA EVOLUTION:

- Diseño extraplano.
- Rótula multidireccional.
- Botón redondo ergonómico.
- Tres modos de luz: fría, natural y cálida.

### DIVA EVOLUTION MODELS:

- *Extra-flat design.*
- *Multidirectional swivel.*
- *Ergonomic round button.*
- *Three light modes: cold, natural and warm.*



REFs: 204005 - 204005-N - 204005-LC - 204005-CC - 204006 - 204006-N - 204006-LC - 204006-CC - 204003 - 204003-N - 204003-LC - 204003-CC - 204004 - 204004-N - 204004-LC - 204004-CC - 204000 - 204001 - 204000-N - 204001-N

## Espejos de aumento *Magnifying mirrors*



LED PARED 170  
*Wall - mounted LED*

SIN LUZ PARED 176  
*Wall - mounted without light*

LED SOBREMESA 182  
*Free standing LED*

SIN LUZ SOBREMESA 184  
*Free standing without light*

DECOR GLASS MIRROR 186

# LED PARED

## Wall-mounted LED

**2 brazos  
1 brazo**

**2 arms  
1 arm**



+ x3 aumentos  
x3 magnifications

### 200206

FUTURLED 2 brazos y 1 cara.  
Alimentación: cable.  
Acabado: cromo brillo.  
FUTURLED 2 arms y 1 side.  
Power: with cable.  
Finish: bright chrome.  
Ø 20 cm.



+ x3 aumentos  
x3 magnifications

### 200104-NV

LUXURY 2 brazos y 1 cara.  
Alimentación: cable.  
Acabado: cromo brillo.  
LUXURY 2 arms y 1 side.  
Power: with cable.  
Finish: bright chrome.  
Ø 23 cm.



+ x3 aumentos  
x3 magnifications

### 200206-N

FUTURLED 2 brazos y 1 cara.  
Alimentación: cable.  
Acabado: negro mate.  
FUTURLED 2 arms y 1 side.  
Power: with cable.  
Finish: matte black.  
Ø 20 cm.



+ x3 aumentos  
x3 magnifications

### 200104-NV-N

LUXURY 2 brazos y 1 cara.  
Alimentación: cable.  
Acabado: negro mate.  
LUXURY 2 arms y 1 side.  
Power: with cable.  
Finish: matte black.  
Ø 23 cm.

**2 brazos  
2 arms**



### 204005

DIVA EVOLUTION 2 brazos y 1 cara.  
Alimentación: cable.  
Acabado: cromo brillo.  
DIVA EVOLUTION 2 arms y 1 side.  
Power: with cable.  
Finish: bright chrome.  
Ø 21,5 cm.

#### 204006

Igual que 204005 pero con pilas (9V).  
Same as 204005 but with batteries (9V).



## 2 brazos 2 arms

### 204005-N

DIVA EVOLUTION 2 brazos y 1 cara.  
Alimentación: cable.  
Acabado: negro mate.  
DIVA EVOLUTION 2 arms y 1 side.  
Power: with cable.  
Finish: matte black.  
Ø 21,5 cm.

#### 204006-N

Igual que 204005-N pero con pilas (9V).  
Same as 204005-N but with batteries (9V).



### 204003

DIVA EVOLUTION 1 brazo y 1 cara.  
Alimentación: cable.  
Acabado: cromo brillo.  
DIVA EVOLUTION 1 arm y 1 side.  
Power: with cable.  
Finish: bright chrome.  
Ø 21,5 cm.

#### 204004

Igual que 204003 pero con pilas (9V).  
Same as 204003 but with batteries (9V).



## 1 brazo 1 arm

### 204003-N

DIVA EVOLUTION 1 brazo y 1 cara.  
Alimentación: cable.  
Acabado: negro mate.  
DIVA EVOLUTION 1 arm y 1 side.  
Power: with cable.  
Finish: matte black.  
Ø 21,5 cm.

#### 204004-N

Igual que 204003-N pero con pilas (9V).  
Same as 204003-N but with batteries (9V).



### 204005-LC

DIVA EVOLUTION 2 brazos y 1 cara.  
Alimentación: cable.  
Acabado: latón cepillado.  
DIVA EVOLUTION 2 arms y 1 side.  
Power: with cable.  
Finish: brushed brass.  
Ø 21,5 cm.

#### 204006-LC

Igual que 204005-LC pero con pilas (9V).  
Same as 204005-LC but with batteries (9V).



### 204005-CC

DIVA EVOLUTION 2 brazos y 1 cara.  
Alimentación: cable.  
Acabado: cobre cepillado.  
DIVA EVOLUTION 2 arms y 1 side.  
Power: with cable.  
Finish: brushed copper.  
Ø 21,5 cm.

#### 204006-CC

Igual que 204005-CC pero con pilas (9V).  
Same as 204005-CC but with batteries (9V).



### 204003-LC

DIVA EVOLUTION 1 brazo y 1 cara.  
Alimentación: cable.  
Acabado: latón cepillado.  
DIVA EVOLUTION 1 arm y 1 side.  
Power: with cable.  
Finish: bright chrome.  
Ø 21,5 cm.

#### 204004-LC

Igual que 204003-LC pero con pilas (9V).  
Same as 204003-LC but with batteries (9V).

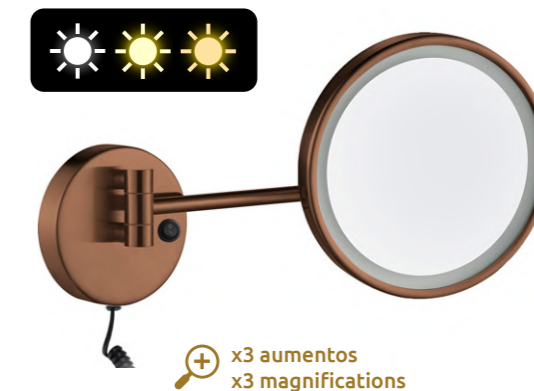

### 204003-CC

DIVA EVOLUTION 1 brazo y 1 cara.  
Alimentación: cable.  
Acabado: cobre cepillado.  
DIVA EVOLUTION 1 arm y 1 side.  
Power: with cable.  
Finish: bright chrome.  
Ø 21,5 cm.

#### 204004-CC

Igual que 204003-CC pero con pilas (9V).  
Same as 204003-CC but with batteries (9V).



+ x3 aumentos  
+ x3 magnifications

### 202500

VALERA OPTIMA LIGHT 1 brazo y 1 cara.  
Alimentación: cable.  
Acabado: cromo brillo.  
VALERA OPTIMA LIGHT 1 arm y 1 side.  
Power: with cable.  
Finish: bright chrome.  
Ø 21,6 cm.



+ x3 aumentos  
+ x3 magnifications

### 200210

KOBE 1 brazo y 1 cara.  
Alimentación: cable.  
Acabado: cromo brillo.  
KOBE 1 arm y 1 side.  
Power: with cable.  
Finish: bright chrome.  
20 x 20 cm.

## 1 brazo 1 arm



# SIN LUZ PARED

*Wall-mounted  
without light*

**2 brazos  
1 brazo**

**2 arms  
1 arm**

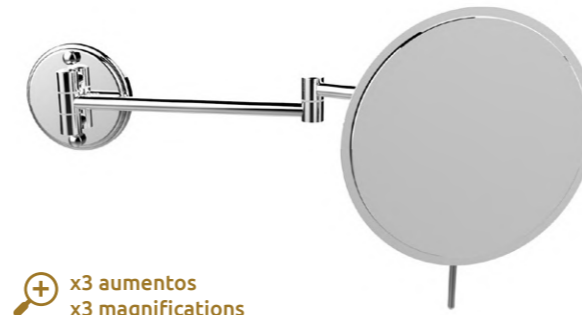

+ x3 aumentos  
x3 magnifications

**200603** ● ● ● ●  
JOYSTICK 2 brazos y 1 cara.  
Acabado: cromo brillo.  
JOYSTICK 2 arms y 1 side.  
Finish: bright chrome.  
Ø 18 cm.



+ x3 aumentos  
x3 magnifications

**200603-LC** ● ● ● ●  
JOYSTICK 2 brazos y 1 cara.  
Acabado: latón cepillado.  
JOYSTICK 2 arms y 1 side.  
Finish: brushed brass.  
Ø 18 cm.

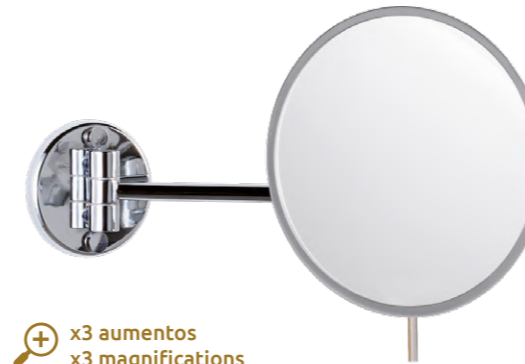

+ x3 aumentos  
x3 magnifications

**200601** ● ● ● ●  
JOYSTICK 1 brazo y 1 cara.  
Acabado: cromo brillo.  
JOYSTICK 1 arm y 1 side.  
Finish: bright chrome.  
Ø 18 cm.

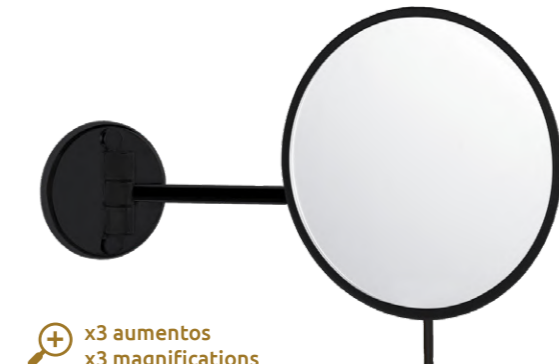

+ x3 aumentos  
x3 magnifications

**200601-N** ● ● ● ●  
JOYSTICK 1 brazo y 1 cara.  
Acabado: negro mate.  
JOYSTICK 1 arm y 1 side.  
Finish: matte black.  
Ø 18 cm.



 x3 aumentos  
x3 magnifications

**200601-2**

JOYSTICK II 1 brazo y 1 cara.  
Acabado: cromo brillo.  
JOYSTICK II 1 arm y 1 side.  
Finish: bright chrome.  
Ø 20 cm.



 x5 aumentos  
x5 magnifications

**201802**

ROUND 2 brazos y 1 cara.  
Acabado: cromo brillo.  
ROUND 2 arms y 1 side.  
Finish: bright chrome.  
Ø 20 cm.



 x3 aumentos  
x3 magnifications

**201900-V**

NOA 1 brazo y 2 caras.  
Acabado: cromo brillo.  
NOA 1 arm y 2 sides.  
Finish: bright chrome.  
Ø 23 cm.



 x4 aumentos  
x4 magnifications

**201800**

NOA BAR 2 brazos y 2 caras.  
Acabado: cromo brillo.  
NOA BAR 2 arms y 2 sides.  
Finish: bright chrome.  
Ø 23 cm.



+ x3 aumentos  
x3 magnifications

**201000**

ECO 2 brazos y 2 caras.  
Acabado: cromo brillo.  
ECO 2 arms y 2 sides.  
Finish: bright chrome.  
Ø 19 cm.



+ x3 aumentos  
x3 magnifications

**201500**

ECO 1 brazo y 2 caras.  
Acabado: cromo brillo.  
ECO 1 arm y 2 sides.  
Finish: bright chrome.  
Ø 20 cm.



+ x3 aumentos  
x3 magnifications

**201500-N**

ECO 1 brazo y 2 caras.  
Acabado: negro mate.  
ECO 1 arm y 2 sides.  
Finish: matte black.  
Ø 20 cm.



+ x3 aumentos  
x3 magnifications

**201500-LC**

ECO 1 brazo y 2 caras.  
Acabado: latón cepillado.  
ECO 1 arm y 2 sides.  
Finish: brushed brass.  
Ø 20 cm.



+ x3 aumentos  
x3 magnifications

**201500-CC**

ECO 1 brazo y 2 caras.  
Acabado: cobre cepillado.  
ECO 1 arm y 2 sides.  
Finish: brushed copper.  
Ø 20 cm.



# LED SOBREMESA

## Free standing LED



**204000** ● ● ● ● ●  
 DIVA EVOLUTION sobremesa 1 cara.  
 Acabado: cromo brillo.  
 Alimentación: cable.  
 DIVA EVOLUTION free standing 1 side.  
 Power: with cable.  
 Finish: bright chrome.  
 Ø 20 cm.

**204001**  
 Igual que 204000  
 pero con pilas (9V).  
 Same as 204000 but  
 with bateries (9V).



**204000-N** ● ● ● ● ●  
 DIVA EVOLUTION sobremesa 1 cara.  
 Acabado: negro mate.  
 Alimentación: cable.  
 DIVA EVOLUTION free standing 1 side.  
 Power: with cable.  
 Finish: matte black.  
 Ø 20 cm.

**204001-N**  
 Igual que 204000-N  
 pero con pilas (9V).  
 Same as 204000-N but  
 with bateries (9V).



**200205** ● ● ● ● ●  
 SENSOR TOUCH sobremesa 1 cara.  
 Acabado: cromo brillo.  
 Alimentación: pilas.  
 SENSOR TOUCH free standing 1 side.  
 Power: batteries.  
 Finish: bright chrome.  
 Ø 20 cm.



**200204** ● ● ● ● ●  
 SENSOR TOUCH sobremesa 1 cara.  
 Acabado: negro mate.  
 Alimentación: pilas.  
 SENSOR TOUCH free standing 1 side.  
 Power: batteries.  
 Finish: matte black.  
 Ø 20 cm.

# SIN LUZ SOBREMESA

*Free standing  
without light*



+ x3 aumentos  
x3 magnifications

## 200602

JOYSTICK III sobremesa 1 cara.  
Acabado: cromo brillo.  
JOYSTICK III free standing 1 side.  
Finish: bright chrome.  
Ø 20 cm.



+ x3 aumentos  
x3 magnifications

## 200111-N

ZAFIRO sobremesa 2 caras. ●●●●●  
Acabado: negro mate.  
ZAFIRO free standing 2 sides.  
Finish: matte black.  
Ø 20 cm.



+ x3 aumentos  
x3 magnifications

## 200111-LC

ZAFIRO sobremesa 2 caras. ●●●●●  
Acabado: laton cepillado.  
ZAFIRO free standing 2 sides.  
Finish: brushed brass.  
Ø 20 cm.



+ x3 aumentos  
x3 magnifications

## 200111

ZAFIRO sobremesa 2 caras. ●●●●●  
Acabado: oro brillo.  
ZAFIRO free standing 2 sides.  
Finish: bright gold.  
Ø 20 cm.

# DECOR GLASS MIRROR



**203000-LC**  
ROUND  
Acabado: laton cepillado.  
Finish: brushed brass.  
Ø 70 cm.

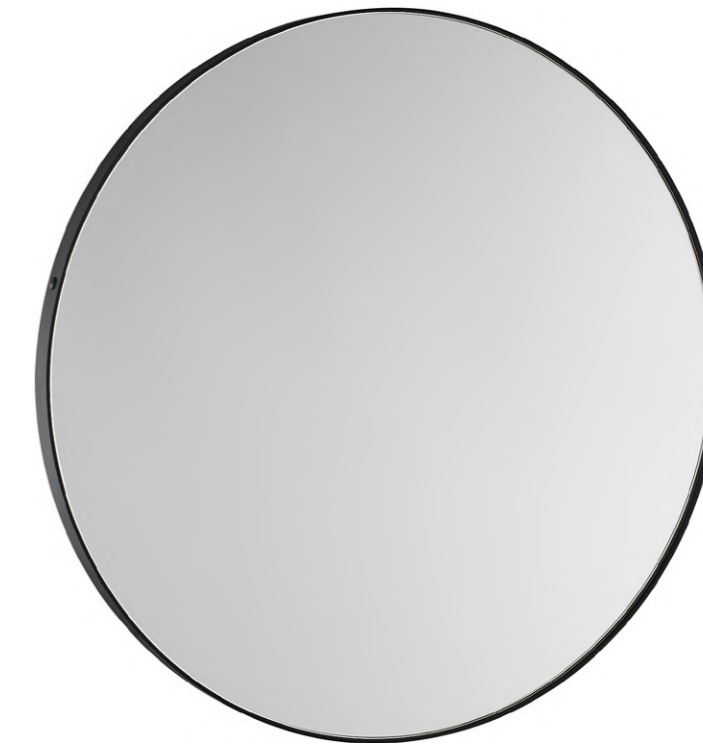

**203000-N**  
ROUND  
Acabado: negro mate.  
Finish: matte black.  
Ø 70 cm.

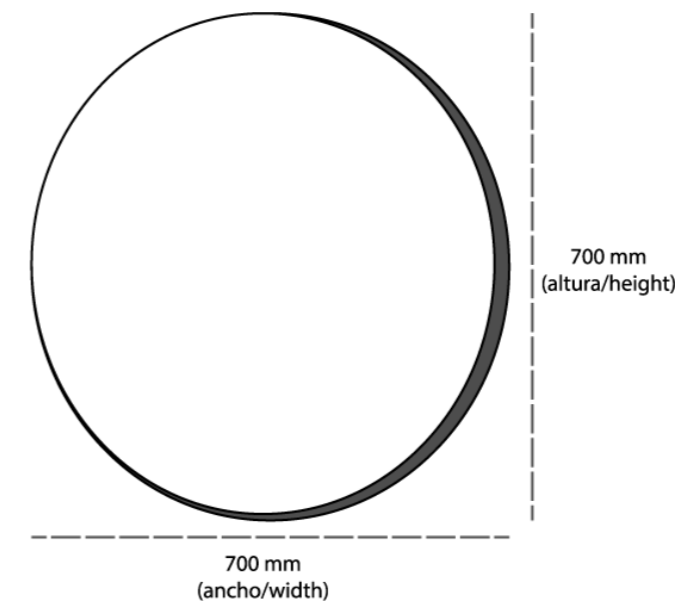



**203100-LC**  
ROUND LED  
Acabado: laton cepillado.  
Finish: brushed brass.  
Ø 70 cm.



**203100-N**  
ROUND LED  
Acabado: negro mate.  
Finish: matte black.  
Ø 70 cm.

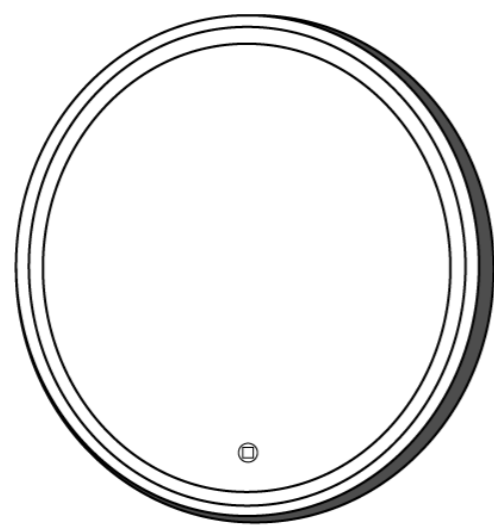

700 mm  
(ancho/width)

700 mm  
(altura/height)





**203200-LC**  
 ROUND LEATHER  
 Acabado: laton cepillado.  
 Finish: brushed brass.  
 Ø 70 cm.

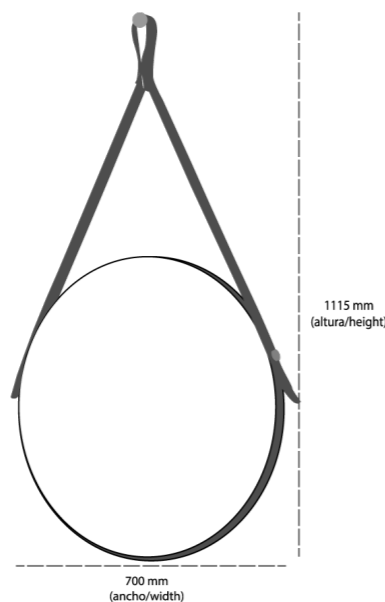

700 mm  
(ancho/width)

1115 mm  
(altura/height)



**203200-N**  
 ROUND LEATHER  
 Acabado: negro mate.  
 Finish: matte black.  
 Ø 70 cm.



**203300-LC**  
 ROUND LEATHER LED  
 Acabado: laton cepillado.  
 Finish: brushed brass.  
 Ø 70 cm.

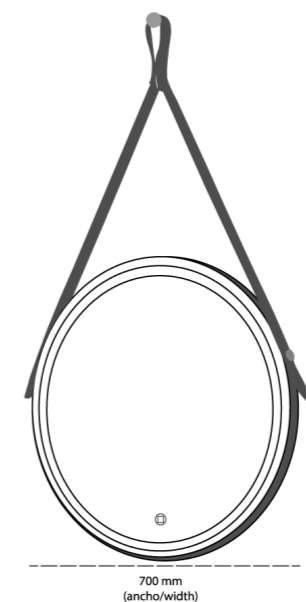

700 mm  
(ancho/width)

1115 mm  
(altura/height)

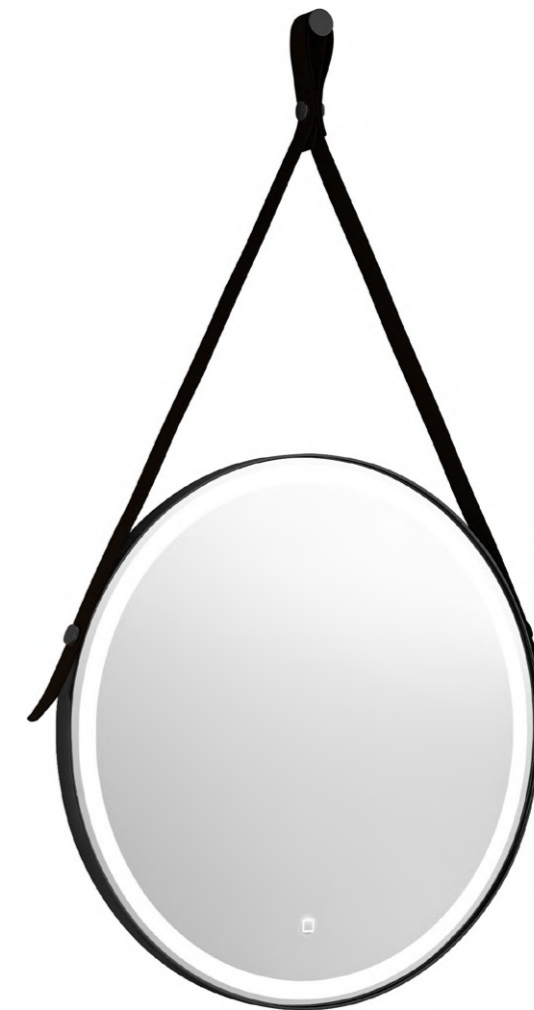

**203300-N**  
 ROUND LEATHER LED  
 Acabado: negro mate.  
 Finish: matte black.  
 Ø 70 cm.



**203400-LC**  
SQUARE  
Acabado: laton cepillado.  
Finish: brushed brass.  
80 x 60 cm.

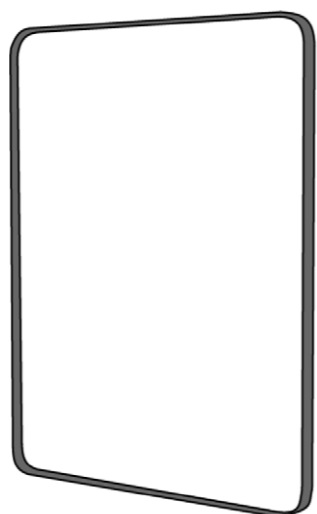

600 mm  
(ancho/width)



**203400-N**  
SQUARE  
Acabado: negro mate.  
Finish: matte black.  
80 x 60 cm.

800 mm  
(altura/height)



**203500-LC**  
SQUARE LED  
Acabado: laton cepillado.  
Finish: brushed brass.  
80 x 60 cm.

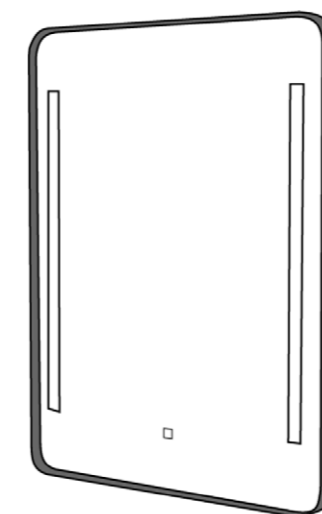

600 mm  
(ancho/width)



**203500-N**  
SQUARE LED  
Acabado: negro mate.  
Finish: matte black.  
80 x 60 cm.

800 mm  
(altura/height)

#### NÚMERO 1 EN SECADORES DE HOTEL

Valera satisface las demandas de los hoteles de clase alta en términos de seguridad, durabilidad, compromiso medioambiental, estética y confort. Todos los años, Valera, suministra secadores para más de 150.000 habitaciones de hoteles en el mundo.

#### SEGURIDAD

Todos los productos de Valera han pasado los estándares de seguridad más altos y llevan los símbolos de los test llevados a cabo por certificadoras internacionales de renombre.

Valera recibió la certificación ISO9001 en 1995.

#### SECADORES EQUIPADOS CON:



1. Termostato de reinicio ya pagado automático para prevenir el sobrecalentamiento.
2. Botón de seguridad de encendido ya pagado "push" para prevenir operación desprotegida.



1. Termostato de reinicio y apagado automático para prevenir el sobrecalentamiento.
2. Fusible térmico de seguridad en caso de sobrecalentamiento accidental.



1. Termostato de reinicio y apagado automático para prevenir el sobrecalentamiento.
2. Botón de seguridad de encendido ya pagado "push" para prevenir operación desprotegida.
3. Interruptor de encendido y apagado de seguridad en el soporte de la pared para parar la operación si fuera necesario



1. Termostato de apagado y reinicio automático para prevenir el sobrecalentamiento.
2. Pulsador desseguridad ON/OFF para evitar su usos inprotección.
3. Interruptor de seguridad ON/OFF automático para detener el funcionamiento cuando se inserta el secador en el soporte.
4. Dispositivo de corriente residual en el soporte de pared.

#### BAJO CONSUMO

Los secadores Valera hacen posible el ahorro de energía, tienen larga vida y logran altas tasas de secado incluso abajos vatios.

#### SOSTENIBILIDAD

El uso exclusivo de cables de forma ondulada garantiza una mayor vida, calidad óptima y seguridad de los secadores. Están fabricados con materiales, los cuales más del 95% pueden ser reciclados y no contienen ninguna sustancia peligrosa o dañina (directiva ROHS). Valera es miembro de la Sociedad suiza de reciclaje de aparatos eléctricos y electrónicos.

#### NUMBER 1 IN HOTEL DRYERS

Valera meets the demands of high-class hotels in terms of safety, durability, environmental commitment, aesthetics and comfort. Every year, Valera supplies dryers for more than 150,000 hotel rooms worldwide.

#### SAFETY

All Valera products have passed the highest safety standards and bear the symbols of tests carried out by renowned international certifiers.

Valera received ISO 9001 certification in 1995.

#### THE DRYERS ARE EQUIPPED WITH:



1. Automatic reset thermostat and automatic shut-off to prevent overheating.
2. Safety on/off push button to prevent unprotected operation.



1. Thermostat reset and automatic shutdown to prevent overheating.
2. Thermal safety fuse in case of accidental overheating.



1. Thermostat reset and automatic shutdown to prevent overheating.
2. Safety on/off push button to prevent unprotected operation.
3. Safety on/off switch on the wall bracket to stop operation if necessary.



1. Thermostat shut-off and automatic restart to prevent overheating.
2. Safety ON/OFF button to prevent unprotected use.
3. Automatic ON/OFF safety switch to stop operation when the dryer is inserted into the wall bracket.
4. Residual current device on the wall bracket.

#### LOW CONSUMPTION

VALERA hairdryers make energy saving settings possible, have a long life and achieve high drying rates even at low wattages.

#### SUSTAINABILITY

The exclusive use of ripple-shaped (not spiral) wires of the heating elements guarantees longer life, optimum quality and safety of hairdryers. They are manufactured from materials 95% of which can be recycled and they do not contain any hazardous or dangerous substances (RoHS directive). VALERA is a member of the Swiss Recycling Society S.EN.S.\*.

# Secadores cabello

## Hairdryers

SECADORES 196  
HAIRDRYERS

PLANCHAS 232  
HAIR STRAIGHTENER



Descubre nuestra completa gama de secadores que se adaptan al estilo y diseño de cualquier estancia, ofreciendo un producto seguro y confortable para los clientes.



- Secadores de pistola y soportes
- Secadores con soporte en pared



- Secadores de pistola
- Secadores con soporte en pared

Discover our complete range of hairdryers that adapt to the style and design of any room, offering a safe and comfortable product for customers.



- Pistol hairdryers and stands
- Wall mounted hairdryers



- Pistol hairdryers
- Wall mounted hairdryers

# SECADORES HAIRDRYERS

# SECADORES PISTOLA *hairdryers*



## MATRIXCARE 2000 W DELUXE 300814 (CROMO/CHROMED)

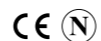
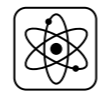

- Secador profesional de alta gama.
- Acabado: cromo brillo.
- Potencia: 2000 W.
- Caudal del aire: 45m³/h - 80 m³/h.
- Secado ultra rápido.
- Ultrasilencioso: 67 dB(A).
- Durabilidad extra larga del motor: 5000 h.
- Generador de iones.
- Accesorios:
  - Boquilla TOUCH ME (boquilla fría): 8.2 cm.
  - Difusor de rizos: Ø 12.7 cm.
- Filtro metálico extraíble.
- 2 configuraciones CARE/MAX:
  - 18 combinaciones de flujo de aire/ temperatura.
- Botón aire frío.
- Cable de SuperFlex.
- Estuche organizador de lujo.

- High-end professional hairdryer.
- Finish: bright chrome.
- Power: 2000 W.
- Air flow: 45m³/h - 80 m³/h.
- Ultra fast drying.
- Ultra quiet: 67 dB(A).
- Extra long motor durability: 5000 h.
- Ion generator.
- Accessories:
  - TOUCH ME nozzle (cold nozzle): 8.2 cm.
  - Curl diffuser: Ø 12.7 cm.
- Removable metal filter.
- 2 CARE/MAX settings:
  - 18 airflow/temperature combinations.
- Cool air button.
- SuperFlex cord.
- Deluxe organiser case.





### MATRIXCARE 2000W 300815 (CROMO/CHROME)

- Secador profesional de alta gama.
- Potencia: 2000 W.
- Caudal del aire: 45m<sup>3</sup>/h - 80 m<sup>3</sup>/h.
- Secado ultra rápido.
- Ultra silencioso: 67 dB(A).
- Durabilidad extra larga del motor: 5000 h.
- Generador de iones.
- Boquilla TOUCH ME (boquilla fría): 8.2 cm.
- Filtro metálico extraíble.
- 2 configuraciones CARE/MAX:
  - 18 combinaciones de flujo de aire/temperatura.
- Botón aire frío.
- Cable de SuperFlex.
- Incluye bolsa de algodón.



### MATRIXCARE 2000W 300816 (NEGRO/BLACK)

- High-end professional hairdryer.
- Power: 2000 W.
- Air flow: 45m<sup>3</sup>/h - 80 m<sup>3</sup>/h.
- Ultra fast drying.
- Ultra quiet: 67 dB(A).
- Extra long motor durability: 5000 h.
- Ion generator.
- TOUCH ME nozzle (cold nozzle): 8.2 cm.
- Removable metal filter.
- 2 CARE/MAX settings:
  - 18 airflow/temperature combinations.
- Cool air button.
- SuperFlex cord.
- Cotton bag.

### MATRIXCARE 1600W 300817

Igual que modelo MATRIXCARE 2000W pero de 1600 W y en color negro.  
Same as model MATRIXCARE 2000W but in 1600 W and black color.



### STEEL MASTER 2100W 306906 (NEGRO/BLACK)

- Potencia: 2100 W.
- Cuerpo metálico de acero.
- Motor ligero AC-PERFORMANCE.
- Desconexión térmica de seguridad.
- Generador de iones.
- Resistencia de seguridad contra calentamiento y resistencia ondulada.
- 6 combinaciones de caudal/temperatura del aire.
- Botón de aire frío.
- Boquilla concentradora ultra estrecha.
- Filtro metálico extraíble.
- Cable en espiral.



- Power: 2100 W.
- Metal body in premium steel.
- AC-PERFORMANCE Light Motor.
- Security thermal cutoff.
- Ion generator.
- Ripple wire SECURITY heating element.
- 6 air flow/temperature combinations.
- Cold air button.
- Ultra-slim concentrator nozzle.
- Removable metallic filter.
- Spiral cable.



### STEEL MASTER 2100W 306905 (ORO/GOLD)

- Potencia: 2100 W.
- Cuerpo metálico de acero.
- Motor ligero AC-PERFORMANCE.
- Desconexión térmica de seguridad.
- Generador de iones.
- Resistencia de seguridad contra calentamiento y resistencia ondulada.
- 6 combinaciones de caudal/temperatura del aire.
- Botón de aire frío.
- Boquilla concentradora ultra estrecha.
- Filtro metálico extraíble.
- Cable en espiral.



- Power: 2100 W.
- Metal body in premium steel.
- AC-PERFORMANCE Light Motor.
- Security thermal cutoff.
- Ion generator.
- Ripple wire SECURITY heating element.
- 6 air flow/temperature combinations.
- Cold air button.
- Ultra-slim concentrator nozzle.
- Removable metallic filter.
- Spiral cable.



**STEEL MASTER 2100W PUSH  
306901-NEW (CROMO/CHROMED)**

- Potencia: 2100 W.
- Cuerpo metálico de acero.
- Motor ligero AC-PERFORMANCE.
- Generador de iones.
- Resistencia de seguridad contra calentamiento y resistencia ondulada.
- 6 combinaciones de caudal/temperatura del aire.
- Botón encendido/apagado.
- Boquilla concentradora ultra estrecha.
- Filtro metálico extraíble.
- Cable en espiral.

- Power: 2100 W.
- Metal body in premium steel.
- AC-PERFORMANCE Light Motor.
- Ion generator.
- Ripple wire SECURITY heating element.
- 6 air flow/temperatura combinations.
- On/Off button.
- Ultra-slim concentrator nozzle.
- Removable metallic filter.
- Spiral cable.



**STEEL MASTER 1800W  
306907 (CROMO/CHROMED)**

- Potencia: 1800 W.
- Cuerpo metálico de acero cromado.
- Motor ligero PM-Pro.
- Botón encendido/apagado.
- Resistencia de seguridad contra calentamiento y resistencia ondulada.
- 6 combinaciones de caudal/temperatura del aire.
- Boquilla concentradora ultra estrecha.
- Filtro metálico extraíble.
- Cable en espiral.

- Power: 1800 W.
- Metal body in premium steel.
- PM-Pro Motor.
- On/Off push button.
- Ripple wire SECURITY heating element.
- 6 air flow/temperatura combinations.
- Ultra-slim concentrator nozzle.
- Removable metallic filter.
- Spiral cable.



**SWISS SILENT JET 8500 IONIC TF 2000W  
306303 (NEGRO/BLACK)**

- Potencia: 2000 W.
- Motor universal AC de LARGA DURACIÓN.
- Desconexión térmica de seguridad.
- Generador de iones.
- Tecnología de flujo de aire inteligente.
- Resistencia de seguridad contra calentamiento y resistencia ondulada.
- 6 ajustes de flujo de aire/temperatura.
- Botón de aire frío.
- Filtro metálico extraíble.
- 2 boquillas concentradoras ultradelgadas:
  - Boquilla TOUCH ME cool (7,5 cm).
  - Boquilla estándar (6 cm).
- Cable SuperFlex con ROTOCORD.

- Power: 2000 W.
- LONG-LIFE AC Universal Motor.
- Security thermal cutoff.
- Ions generator.
- Smart AirFlow Technology.
- Ripple wire SECURITY heating element.
- 6 air flow/temperatura settings.
- Cold air button.
- Removable metallic filter.
- 2 ultra-Slim concentrator nozzles:
  - TOUCH ME cold nozzle (7,5 cm)
  - Standard nozzle (6 cm)
- SuperFlex cable with ROTOCORD.

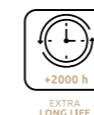

**SWISS SILENT JET 8500 PUSH  
306305 (NEGRO/BLACK)  
306308 (BLANCO/WHITE)**

- Potencia: 2000 W.
- Motor universal AC de LARGA DURACIÓN.
- Botón encendido/apagado.
- Tecnología de flujo de aire inteligente.
- Resistencia de seguridad contra calentamiento y resistencia ondulada.
- 6 ajustes de flujo de aire/temperatura.
- Filtro metálico extraíble.
- Boquilla TOUCH ME cool (7,5 cm).
- Cable espiral.

- Power: 2000 W.
- LONG-LIFE AC Universal Motor.
- Security thermal cutoff.
- On/Off push button.
- Smart AirFlow Technology.
- Ripple wire SECURITY heating element.
- 6 air flow/temperatura settings.
- Cold air button.
- Removable metallic filter.
- TOUCH ME cold nozzle (7,5 cm)
- Spiral cable.





**EXCEL 2000W IONIC TF  
303401-NEW (NEGRO/BLACK)**

- Potencia: 2000 W.
- Desconexión térmica de seguridad.
- Generador de iones.
- Resistencia de seguridad contra calentamiento y resistencia ondulada.
- 6 combinaciones de caudal/temperatura del aire.
- Configuración de aire frío.
- Boquilla concentradora.
- Filtro extraíble.
- Cable SuperFlex.
- Power: 2000 W.
- Security thermal cutoff.
- Ion generator.
- Ripple wire SECURITY heating element.
- 6 air flow/temperatura combinations.
- Cold air settings.
- Concentrator nozzle.
- Removable filter.
- SuperFlex cable.



**PLEGABLE FOLD AWAY 2000W IONIC TF  
303601 (NEGRO/BLACK)**

- Potencia: 2000 W.
- Generador de iones.
- Tecnología tourmaline.
- Motor DC de larga duracón.
- Desconexión térmica de seguridad.
- 6 combinaciones de caudal/temperatura del aire.
- Botón de aire frío.
- Rejilla de aire con bisagras.
- Boquilla concentradora.
- Cable SuperFlex.
- Power: 2000 W.
- Ions generator.
- Long-life DC motor.
- Security thermal cutoff.
- 6 air flow/temperatura combinations.
- Cool air button.
- Concentrator nozzle.
- Hinged air inlet grille.
- SuperFlex cable.



**EXCEL 1800W  
310002-N (NEGRO/BLACK)**

- Potencia: 1800 W.
- Desconexión térmica de seguridad.
- Botón encendido/apagado.
- Resistencia de seguridad contra calentamiento y resistencia ondulada.
- 6 ajustes de flujo de aire/temperatura.
- Botón de aire frío.
- Boquilla concentradora.
- Filtro extraíble.
- Cable SuperFlex.
- Power: 1800 W.
- Security thermal cutoff.
- On/Off push button.
- Ripple wire SECURITY heating element.
- 6 air flow/temperature combinations.
- Cold air button.
- Concentrator nozzle.
- Removable filter.
- SuperFlex cable.



**EXCEL 1875 PUSH  
303301 (BLANCO/WHITE)**

- Potencia: 1875 W.
- Resistencia de seguridad contra calentamiento y resistencia ondulada.
- Botón encendido/apagado.
- 6 combinaciones de caudal/temperatura del aire.
- Configuración de aire frío.
- Boquilla concentradora.
- Filtro extraíble.
- Cable en espiral.
- Power: 1875 W.
- Ripple wire SECURITY heating element.
- On/Off push button.
- 6 air flow/temperature combinations.
- Cold air setting.
- Removable filter.
- Concentrator nozzle.
- Spiral cable



**EXCEL 1600 PUSH**

**303300**

Igual que modelo EXCEL 1875 PUSH pero de 1600W.  
Same as model EXCEL 1875 PUSH but 1600W.



**EXCEL 1800W**  
**310000-N (NEGRO/BLACK)**

- Potencia: 1800 W.
- Incluye soporte.
- Desconexión térmica de seguridad.
- Botón encendido/apagado
- Resistencia de seguridad contra calentamiento y resistencia ondulada.
- 6 ajustes de flujo de aire/temperatura.
- Botón de aire frío.
- Boquilla concentradora.
- Filtro extraíble.
- Cable SuperFlex.
- Power: 1800 W.
- Wall holder included.
- Security thermal cutoff.
- On/off button
- Ripple wire SECURITY heating element.
- 6 air flow/temperature combinations.
- Cold air button.
- Concentrator nozzle.
- Removable filter.
- SuperFlex cable.



**EXCEL 1800 TF**  
**310001**

Igual que 310000-N pero sin botón on-off y con cable liso.  
Same as 310000-N but without on-off button and with plain cable.



**ACTION 1600W PUSH**  
**303100 (CROMO-NEGRO/CHROMED-BLACK)**

- Potencia: 1600 W.
- Resistencia de seguridad contra calentamiento y resistencia ondulada.
- 2 ajustes de flujo de aire.
- 3 ajustes de temperatura.
- Configuración aire frío.
- Boquilla concentradora.
- Cable espiral.
- Power: 1600 W.
- Ripple wire SECURITY heating element.
- 2 air flow settings.
- 3 temperature settings.
- Cold air button.
- Concentrator nozzle.
- Removable filter.
- SuperFlex cable.



**ACTION 1200 PUSH**  
**303200**

Igual que modelo ACTION 1600 PUSH pero de 1200W.  
Same as ACTION 1600 PUSH but 1200W.



**ACTION 1800W PUSH**  
**303104 (NEGRO/ALL BLACK)**

- Potencia: 1800 W.
- Resistencia de seguridad contra calentamiento y resistencia ondulada.
- Botón encendido/apagado.
- 2 ajustes de flujo de aire.
- 3 ajustes de temperatura.
- Configuración aire frío.
- Boquilla concentradora.
- Cable espiral.



**ACTION 1800W PUSH**  
**303103 (CROMO-BLANCO/CHROMED-WHITE)**

- Power: 1800 W.
- Ripple wire SECURITY heating element.
- On/Off push button.
- 2 air flow settings.
- 3 temperature settings.
- Concentrator nozzle.
- Spiral cable.



**ACTION 1800W PUSH**  
**303102 (CROMO-NEGRO/CHROMED-BLACK)**



**PREMIUM 1600W PUSH  
303500 (BLANCO/WHITE)**

- Potencia: 1600 W.
- Resistencia de seguridad de alambre ondulado.
- Botón encendido/apagado.
- 2 ajustes de flujo de aire.
- 3 ajustes de temperatura.
- Configuración aire frío.
- Boquilla concentradora.
- Cable espiral.
- Power: 1600 W.
- Ripple wire SECURITY heating element.
- 2 air flow settings.
- 3 temperature settings.
- Cold air setting.
- Concentrator nozzle.
- Spiral cable.



**EXECUTIVE 1200W PUSH  
303501 (BLANCO/WHITE)**

- Potencia: 1200 W.
- Resistencia de seguridad contra calentamiento y resistencia ondulada.
- Botón encendido/apagado.
- 2 combinaciones de flujo de aire/temperatura.
- Boquilla concentradora.
- Cable espiral.
- Power: 1200 W.
- Ripple wire SECURITY heating element.
- On/Off push button.
- 2 temperature/air flow settings.
- Concentrator nozzle.
- Spiral cable.



# DIMENSIONES

## Dimensions

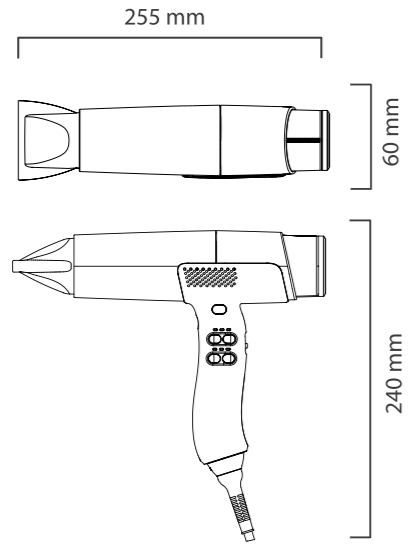

**MOD: 300814-300815-300816-300817**

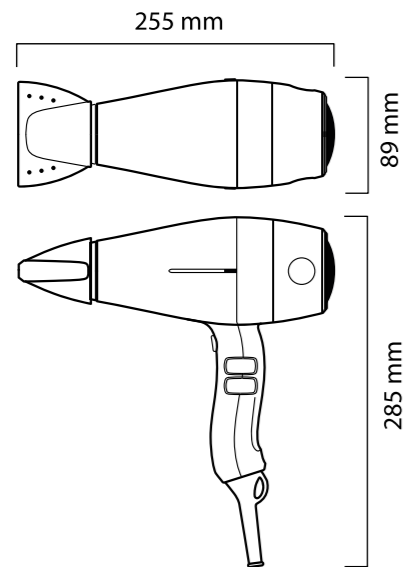

**MOD: 306305-306303-306308**

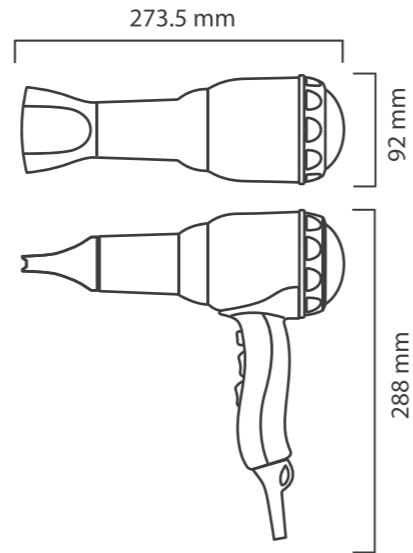

**MOD: 306906-306905-306901-NEW-306907**

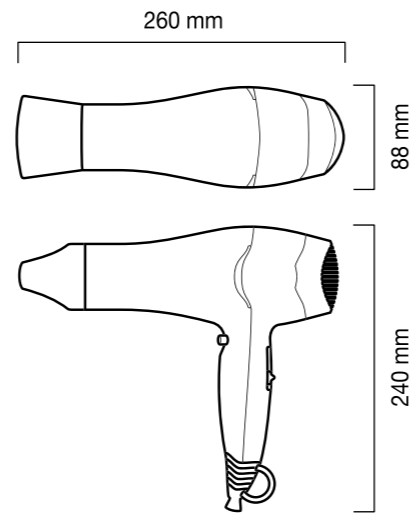

**MOD: 303401-NEW-310002-N-303301  
303300-310000-N-310001**

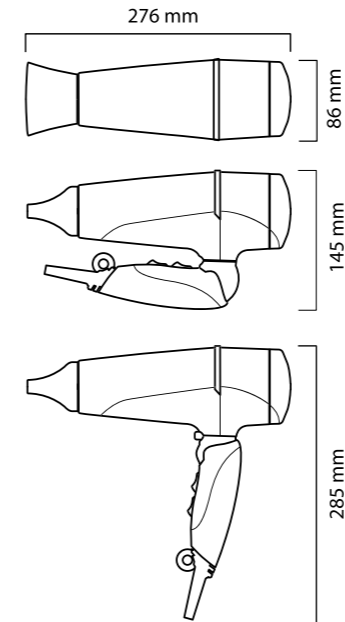

**MOD: 303601**

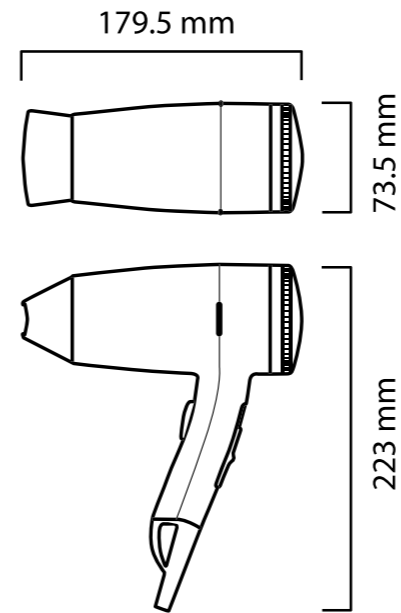

**MOD: 303500**

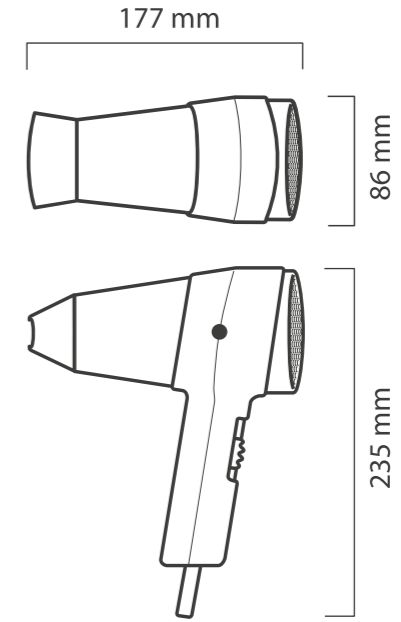

**MOD: 303100-303200-303104-303103-303102**

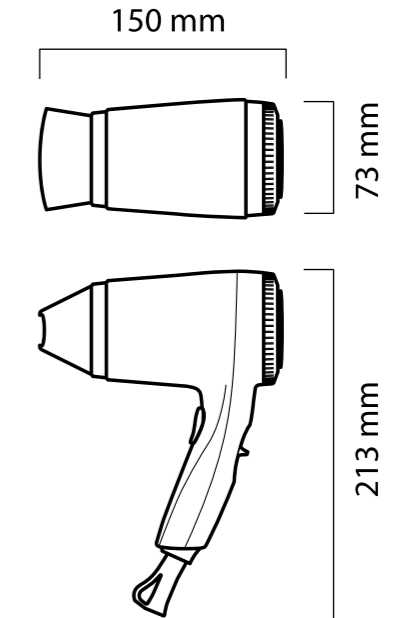

**MOD: 303501**

# SOPORTES Holders



**305000**  
Soporte JOLLY para secador antirrobo.  
Acabado: cromo brillo.  
Anti-theft hairdryer holder.  
Finish: bright chrome.



**305001**  
Soporte JOLLY para secador antirrobo.  
Acabado: transparente.  
Anti-theft hairdryer holder.  
Finish: transparent.



**305003/305003-N**  
Soporte metálico con sistema antirrobo.  
Acabado: cromo brillo/ negro mate.  
Metal bracket with anti-theft system.  
Finish: bright chrome/matte black.



**305202**  
Soporte secador para pared.  
Acabado: negro mate.  
Hairdryer wall holder.  
Finish: matte black.



**305300-NEW**  
Bolsa de algodón para secador.  
Acabado: negro.  
Cotton bag for hairdryer.  
Finish: black.



**051900**  
Soporte metal anilla.  
Acabado: cromo brillo.  
Metal ring holder.  
Finish: bright chrome.



**305201/305200**  
Soporte universal ABS.  
Acabado: cromo brillo/ negro mate.  
Universal ABS holder.  
Finish: bright chrome/matte black.



**126166**  
Soporte de secador colgante.  
Acabado: cromo brillo.  
Hanging hairdryer holder.  
Finish: bright chrome.



**126167**  
Soporte de secador colgante.  
Acabado: blanco.  
Hanging hairdryer holder.  
Finish: white.



**126168**  
Soporte de secador colgante.  
Acabado: negro.  
Hanging hairdryer holder.  
Finish: black.

# SECADORES PARED

## Wall hairdryers



### SILENT JET PROTECT 2000W 309308 (BLANCO/WHITE)

- Potencia: 2000 W.
- Motor AC larga duración.
- Tecnología de flujo de aire inteligente.
- 6 ajustes de flujo de aire/temperatura.
- Filtro metálico extraíble.
- Boquilla concentradora.
- Botón encendido/apagado.
- Resistencia de seguridad contra calentamiento y resistencia ondulada.
- Soporte para pared con:
  - Electrostop: dispositivo corriente residual RCD  $\leq 10\text{mA}$ .
  - Interruptor de seguridad automático de encendido apagado.

- Power: 2000 W.
- LONG-LIFE AC Universal Motor.
- Smart Airflow Technology.
- 6 air flow/temperature settings.
- Removable metallic filter.
- Concentrator nozzle.
- On/Off push button.
- Ripple wire security heating element.
- Wall-holder with:
  - ELECTROSTOP - RCD residual current device 10mA.
  - Automatic On/Off safety switch.



### SILENT JET PROTECT 2000W SHAVER 309301 (BLANCO/WHITE)

- Potencia: 2000 W.
- Motor AC larga duración.
- Tecnología de flujo de aire inteligente.
- 6 ajustes de flujo de aire/temperatura.
- Filtro metálico extraíble.
- Boquilla concentradora.
- Botón encendido/apagado.
- Resistencia de seguridad contra calentamiento y resistencia ondulada.
- Soporte para pared con:
  - Electrostop: dispositivo corriente residual RCD  $\leq 10\text{mA}$ .
  - Toma para afeitadora: 110-120V y 220-240V.
  - Transformador de aislamiento de seguridad.
  - Interruptor de seguridad automático de encendido/apagado.

- Power: 2000 W.
- LONG-LIFE AC Universal Motor.
- Smart Airflow Technology.
- 6 air flow/temperature settings.
- Removable metallic filter.
- Concentrator nozzle.
- On/Off push button.
- Ripple wire security heating element.
- Wall-holder with:
  - ELECTROSTOP - RCD residual current device 10mA.
  - Shaver socket 110-120V and 220-240V.
  - Safety isolating transformer.
  - Automatic On/Off safety switch.



110-120V  
220-240V



SECURITY  
SHAVER  
SOCKET



**EXCEL 1600 SHAVER  
301300 (BLANCO/WHITE)**

- Potencia: 1600 W.
- Resistencia de seguridad contra calentamiento y resistencia ondulada.
- Interruptor de control de caudal de aire: 2 ajustes.
- Interruptor de control de temperatura: 3 ajustes.
- 6 combinaciones de flujo/temperatura del aire.
- Configuración aire frío.
- Botón encendido/apagado.
- Soporte para pared con:
  - Interruptor de seguridad automático de encendido/apagado.
  - Toma para afeitadora: 110-120V y 220-240V.
  - Transformador de aislamiento de seguridad.



**EXCEL 1600 SHAVER  
301302 (SATINADO/SATIN)**

- Power 1600 W.
- Ripple wire SECURITY heating element.
- Air flow control switch: 2 settings.
- Air temperature control switch: 3 settings.
- 6 air flow/ temperature combinations.
- COOL air setting.
- Removable filter.
- On/Off push button.
- Wall-Holder with:
  - Automatic On/Off safety switch.
  - Shaver socket 110-120V and 220-240V.
  - Safety isolating transformer.

**EXCEL 1600 SHAVER  
303011 (NEGRO/BLACK)**



**PREMIUM SMART 1600 SOCKET  
301001 (BLANCO/WHITE)**

- Potencia: 1600 W.
- Resistencia de seguridad contra calentamiento y resistencia ondulada.
- Interruptor deslizante con 2 ajustes de flujo de aire y 3 ajustes de temperatura.
- Configuración aire frío.
- Botón encendido/apagado.
- Soporte para pared con:
  - Interruptor de seguridad automático de encendido/apagado.
  - Toma de corriente europea estándar de 16A.



- Power 1600 W.
- Ripple wire SECURITY heating element.
- Slide switch: 2 air flow settings and 3 air temperature settings.
- COOL air setting.
- On/Off push button.
- Concentrator nozzle.
- Wall-Holder with:
  - Automatic On/Off safety switch.
  - Standard European socket 16A.

**PREMIUM SMART 1200 SOCKET  
301000**

Igual que modelo PREMIUM SMART 1600 SOCKET pero de 1200W.  
Same as model PREMIUM SMART 1600 SOCKET but 1200W.



**PREMIUM SMART 1600 SHAVER  
301101 (BLANCO/WHITE)**

- Potencia: 1600 W.
- Resistencia de seguridad contra calentamiento y resistencia ondulada.
- Interruptor deslizante con 2 ajustes de flujo de aire y 3 ajustes de temperatura.
- Configuración aire frío.
- Botón encendido/apagado.
- Soporte para pared con:
  - Interruptor de seguridad automático de encendido/apagado.
  - Toma para afeitadora: 110-120V y 220-240V.
  - Transformador de aislamiento de seguridad.



- Power 1600 W.
- Ripple wire SECURITY heating element.
- Slide switch: 2 air flow settings and 3 air temperature settings.
- COOL air setting.
- On/Off push button.
- Concentrator nozzle.
- Wall-Holder with:
  - Automatic On/Off safety switch.
  - Shaver socket 110-120V and 220-240V.
  - Safety isolating transformer.

**PREMIUM SMART 1200 SHAVER  
301200**

Igual que modelo PREMIUM SMART 1600 SHAVER pero de 1200W.  
Same as model PREMIUM SMART 1600 SHAVER but 1200W.



**ACTION SUPER PLUS SHAVER 1600W  
300805 (BLANCO-CROMO/WHITE-CHROMED)**

- Potencia: 1600 W.
- Resistencia de seguridad contra calentamiento y resistencia ondulada.
- Interruptor deslizable con 2 ajustes de flujo de aire y 3 ajustes de temperatura.
- Configuración aire frío.
- Botón encendido/apagado.
- Soporte para pared con:
  - Interruptor de seguridad automático de encendido/apagado.
  - Toma para afeitadora: 110-120V y 220-240V.
  - Transformador de aislamiento de seguridad.

**ACTION SUPER PLUS SHAVER 1600W  
300809 (CROMO-SATINADO/CHROMED-SATIN)**

- Power 1600 W.
- Ripple wire SECURITY heating element.
- Slide switch: 2 air flow settings and 3 air temperature settings.
- COOL air setting.
- On/Off push button.
- Concentrator nozzle.
- Wall-Holder with:
  - Automatic On/Off safety switch.
  - Shaver socket 110-120V and 220-240V.
  - Safety isolating transformer.



**ACTION SUPER PLUS 1600W  
300800 (BLANCO-CROMO/WHITE-CHROMED)**

- Potencia: 1600 W.
- Resistencia de seguridad contra calentamiento y resistencia ondulada.
- Interruptor deslizable con 2 ajustes de flujo de aire y 3 ajustes de temperatura.
- Configuración aire frío.
- Botón encendido/apagado.
- Soporte para pared con:
  - Interruptor de seguridad automático de encendido/apagado.



**ACTION SUPER PLUS 1800W  
300804 (BLANCO-CROMO/WHITE-CHROMED)**  
Igual que modelo ACTION SUPER PLUS 1600 pero de 1800W.  
Same as model ACTION SUPER PLUS 1600W but 1800W.

**ACTION SUPER PLUS 1200W  
300900 (BLANCO-CROMO/WHITE-CHROMED)**  
Igual que modelo ACTION SUPER PLUS 1600 pero de 1200W.  
Same as model ACTION SUPER PLUS 1600W but 1200W.



**ACTION SUPER PLUS 1600W  
300801 (NEGRO-CROMO/BLACK-CHROMED)**

- Power 1600 W.
- Ripple wire SECURITY heating element.
- Slide switch: 2 air flow settings and 3 air temperature settings.
- COOL air setting.
- On/Off push button.
- Concentrator nozzle.
- Wall-Holder with:
  - Automatic On/Off safety switch.

**ACTION SUPER PLUS 1800W  
300806 (NEGRO-CROMO/BLACK-CHROMED)**  
Igual que modelo ACTION SUPER PLUS 1600 pero de 1800W.  
Same as model ACTION SUPER PLUS 1600W but 1800W.

**ACTION SUPER PLUS 1200W  
300901 (NEGRO-CROMO/BLACK-CHROMED)**  
Igual que modelo ACTION SUPER PLUS 1600 pero de 1200W.  
Same as model ACTION SUPER PLUS 1600W but 1200W.





**ACTION SUPER PLUS 1800W  
300803 (SATINADO/SATIN)**

- Potencia: 1800 W.
- Resistencia de seguridad contra calentamiento y resistencia ondulada.
- Interruptor deslizante con 2 ajustes de flujo de aire y 3 ajustes de temperatura.
- Configuración aire frío.
- Botón encendido/apagado.
- Boquilla concentradora.
- Soporte para pared con:
  - Interruptor de seguridad automático de encendido/apagado.

**ACTION SUPER PLUS 1800W  
300808 (WHITE/BLANCO)**

- Power 1800 W.
- Ripple wire SECURITY heating element.
- Slide switch: 2 air flow settings and 3 air temperature settings.
- COOL air setting.
- On/Off push button.
- Concentrator nozzle.
- Wall-Holder with:
  - Automatic On/Off safety switch.

**ACTION SUPER PLUS 1800W  
300810 (NEGRO/BLACK)**

**EXECUTIVE 1200W  
303800 (BLANCO/WHITE)**

- Potencia: 1200 W.
- Resistencia de seguridad contra calentamiento y resistencia ondulada.
- Botón encendido/apagado.
- 1 ajuste de aire/temperatura.
- Boquilla concentradora.
- Soporte para pared con conexión a red eléctrica sin interruptor.
- Power 1200 W.
- Ripple wire SECURITY heating element.
- On/Off push button.
- 1 temperature/air flow setting.
- Concentrator nozzle.
- Wall-Holder with connection to electrical mains without switch.

**EXECUTIVE 1200W SUPER  
303801 (BLANCO/WHITE)**

- Potencia: 1200 W.
- Resistencia de seguridad contra calentamiento y resistencia ondulada.
- Interruptor deslizante con 2 ajustes de flujo de aire y 3 ajustes de temperatura.
- Botón encendido/apagado.
- Boquilla concentradora.
- Soporte para pared con botón de seguridad encendido/apagado.
- Power 1200 W.
- Ripple wire SECURITY heating element.
- Slide switch: 2 temperature/air flow settings.
- On/Off push button.
- Concentrator nozzle.
- Wall-Holder with On/Off safety switch.





**PREMIUM 1100W  
300501 (BLANCO/WHITE)**

- Potencia: 1100 W.
- Resistencia de seguridad contra calentamiento y resistencia ondulada.
- Botón encendido/apagado.
- 1 ajuste de aire/temperatura.
- Boquilla concentradora.
- Soporte para pared con conexión a red eléctrica sin interruptor
- Power 1100 W.
- Ripple wire SECURITY heating element.
- On/Off push button.
- 1 temperature/air flow setting.
- Concentrator nozzle.
- Wall-Holder with connection to electrical mains without switch.



**PREMIUM DRAWER 1200W  
300600 (BLANCO/WHITE)**

- Potencia: 1200 W.
- Resistencia de seguridad contra calentamiento y resistencia ondulada.
- Interruptor deslizante con 2 ajustes de flujo de aire y 3 ajustes de temperatura.
- Ajuste aire frío.
- Botón encendido/apagado.
- Boquilla concentradora.
- Soporte para pared interruptor de seguridad On/Off con piloto luminoso.
- Cable de 3 m para conexión a la red eléctrica.
- Power 1200 W.
- Ripple wire SECURITY heating element
- Slide switch: 2 temperature/air flow settings.
- Cool air setting.
- On/Off push button.
- Concentrator nozzle.
- Wall-Holder with On/Off safety switch with pilot lamp.
- Cable 3 m for connection to electrical mains.
- Automatic On/Off safety switch.



**PREMIUM 1600W SUPER  
300100 (BLANCO/WHITE)**

- Potencia: 1600 W.
- Resistencia de seguridad contra calentamiento y resistencia ondulada.
- Interruptor deslizante con 2 ajustes de flujo de aire y 3 ajustes de temperatura.
- Ajuste de aire frío.
- Botón encendido/apagado.
- Boquilla concentradora.
- Soporte para pared con interruptor de seguridad automático de encendido/apagado.
- Power 1600 W.
- Ripple wire SECURITY heating element.
- Slide switch: 2 temperature/air flow settings.
- Cool air setting.
- On/Off push button.
- Concentrator nozzle.
- Wall-holder with On/Off safety switch.



**PREMIUM 1600W  
300200 (BLANCO/WHITE)**

- Potencia: 1600 W.
- Resistencia de seguridad contra calentamiento y resistencia ondulada.
- Botón encendido/apagado.
- 1 ajuste de aire/temperatura.
- Boquilla concentradora.
- Soporte para pared con conexión a red eléctrica sin interruptor.
- Power 1600 W.
- Ripple wire SECURITY heating element.
- On/Off push button.
- 1 temperature/air flow setting.
- Concentrator nozzle.
- Wall-Holder with connection to electrical mains without switch.



**PREMIUM 1200W SUPER  
300300**

Igual que modelo PREMIUM 1600 SUPER pero de 1200W.  
Same as model PREMIUM 1600 SUPER but 1200W.

**PREMIUM 1200W  
300400**

Igual que modelo PREMIUM 1600 pero de 1200W.  
Same has model PREMIUM 1600 but 1200W.



**HOTELLO 1200W**  
**302900 (BLANCO/WHITE)**  
**302901 (SATINADO/SATIN)**

- Potencia 1200 W.
- Súper compacto (147 x 238 mm).
- Potente flujo de aire gracias a un módulo de aireación rediseñado.
- Encendido automático al retirar el mango del soporte.
- Temporizador automático de seguridad de 8 minutos.
- Mango giratorio frío al tacto.
- Tubo flexible y extensible (hasta 1,20 m.)
- Fácil montaje sin necesidad de agujeros.
- 2 posibilidades de cableado eléctrico:
  - Conexión directa a la red eléctrica (hardwire).
  - Conexión con enchufe (softwire).
- Resistencia de seguridad contra calentamiento y resistencia ondulada.

- Power 1200 W.
- Super compact (147 x 238 mm).
- Powerful airflow thanks to a re-designed aeration module.
- Automatic switching on when removing the handgrip from holder.
- 8 mins automatic safety timer.
- "Cool touch" swivel handgrip.
- Extensible hose (up to m 1,20).
- Easy wall-mounting without opening.
- 2 possibilities of electrical wiring:
  - Direct connection to electrical mains (hardwire).
  - Connection with plug (softwire).
- Ripple wire SECURITY heating element.



**HOTELLO SUPER AC**  
**302903 (BLANCO/WHITE)**

- Potencia 1400 W.
- Súper compacto (147 x 238 mm).
- Potente flujo de aire gracias a un módulo de aireación rediseñado.
- Motor AC de larga duración.
- Encendido automático al retirar el mango del soporte.
- Temporizador automático de seguridad de 8 minutos.
- Mango giratorio frío al tacto.
- Tubo flexible y extensible (hasta 1,20 m.)
- Fácil montaje sin necesidad de agujeros.
- 2 posibilidades de cableado eléctrico:
  - conexión directa a la red eléctrica (hardwire)
  - conexión con enchufe (softwire)
- Resistencia de seguridad contra calentamiento y resistencia ondulada.

- Power 1400 W.
- Super compact (147 x 238 mm).
- Powerful airflow thanks to a re-designed aeration module.
- EXTRA LONG-LIFE AC Universal Motor.
- Automatic switching on when removing the handgrip from holder.
- 8 mins automatic safety timer.
- "Cool touch" swivel handgrip.
- Extensible hose (up to m 1,20).
- Easy wall-mounting without opening.
- 2 possibilities of electrical wiring:
  - Direct connection to electrical mains (hardwire).
  - Connection with plug (softwire).
- Ripple wire SECURITY heating element.



**HOTELLO SUPER AC SHAVER**  
**302905 (NEGRO/BLACK)**

- Potencia 1400 W.
- Súper compacto (147 x 238 mm).
- Potente flujo de aire gracias a un módulo de aireación rediseñado.
- Motor AC de larga duración.
- Encendido automático al retirar el mango del soporte.
- Temporizador automático de seguridad de 8 minutos.
- Mango giratorio frío al tacto.
- Tubo flexible y extensible (hasta 1,20 m.)
- Toma para afeitadora: 110-120V y 220-240V.
- Transformador de aislamiento de seguridad.
- Fácil montaje sin necesidad de agujeros.
- 2 posibilidades de cableado eléctrico:
  - Conexión directa a la red eléctrica (hardwire).
  - Conexión con enchufe (softwire).
- Resistencia de seguridad contra calentamiento y resistencia ondulada.

- Power 1400 W.
- Super compact (147 x 238 mm).
- Powerful airflow thanks to a re-designed aeration module.
- EXTRA LONG-LIFE AC Universal Motor.
- Automatic switching on when removing the handgrip from holder.
- 8 mins automatic safety timer.
- "Cool touch" swivel handgrip.
- Extensible hose (up to m 1,20).
- Shaver socket 110-120V and 220-240V.
- Safety isolating transformer.
- Easy wall-mounting without opening.
- 2 possibilities of electrical wiring:
  - Direct connection to electrical mains (hardwire).
  - Connection with plug (softwire).
- Ripple wire SECURITY heating element.



**HOTELLO 1200 SHAVER**  
**303000 (BLANCO/WHITE)**

- Potencia 1200 W.
- Súper compacto (147 x 238 mm).
- Potente flujo de aire gracias a un módulo de aireación rediseñado.
- Encendido automático al retirar el mango del soporte.
- Temporizador automático de seguridad de 8 minutos.
- Mango giratorio frío al tacto.
- Tubo flexible y extensible (hasta 1,20 m.)
- Toma para afeitadora: 110-120V y 220-240V.
- Transformador de aislamiento de seguridad.
- Fácil montaje sin necesidad de agujeros.
- 2 posibilidades de cableado eléctrico:
  - Conexión directa a la red eléctrica (hardwire)
  - Conexión con enchufe (softwire)
- Resistencia de seguridad contra calentamiento y resistencia ondulada.

- Power 1200 W.
- Super compact (147 x 238 mm).
- Powerful airflow thanks to a re-designed aeration module.
- Automatic switching on when removing the handgrip from holder.
- 8 mins automatic safety timer.
- "Cool touch" swivel handgrip.
- Extensible hose (up to m 1,20).
- Shaver socket 110-120V and 220-240V.
- Safety isolating transformer.
- Easy wall-mounting without opening.
- 2 possibilities of electrical wiring:
  - Direct connection to electrical mains (hardwire).
  - Connection with plug (softwire).
- Ripple wire SECURITY heating element.



# DIMENSIONES

## Dimensions

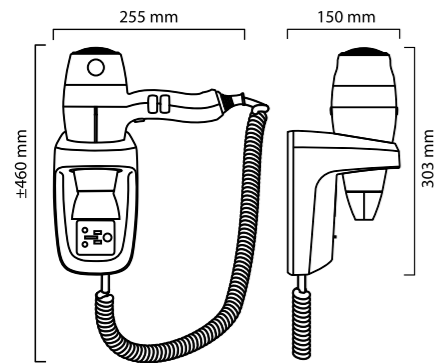

**MOD: 309308-309301**

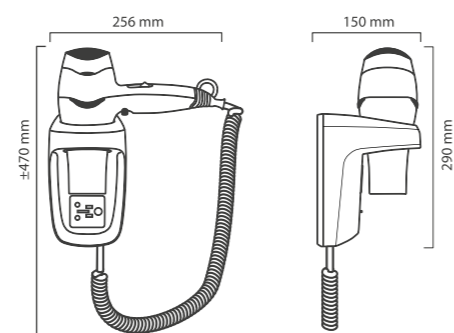
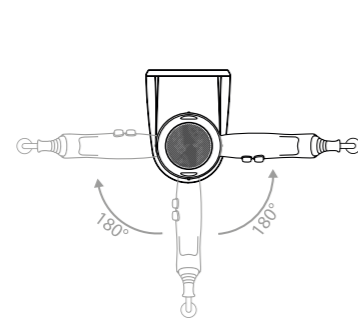

**MOD: 301300-301302-303011**

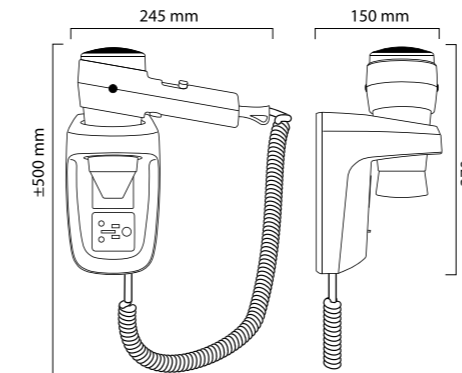
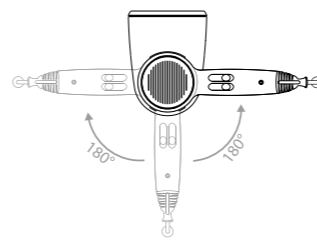

**MOD: 300800-300804-300900-300801-300806-300901**

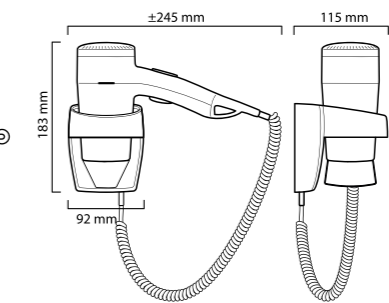
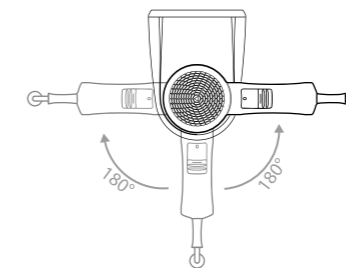

**MOD: 300501-300100-300300-300200-300400**

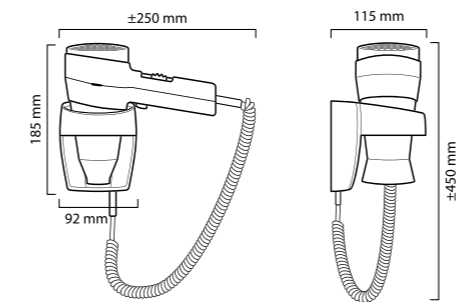
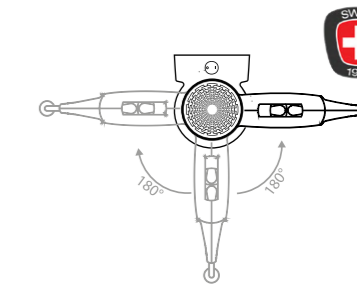

**MOD: 300803-300808-300810**

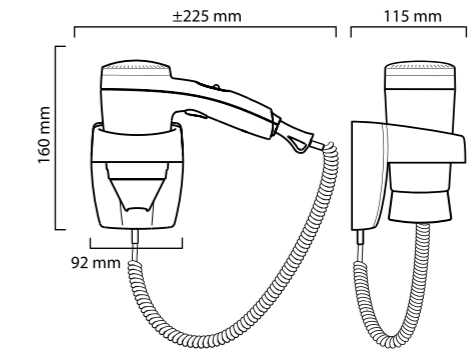
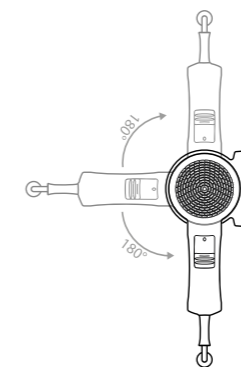

**MOD: 303800-303801**

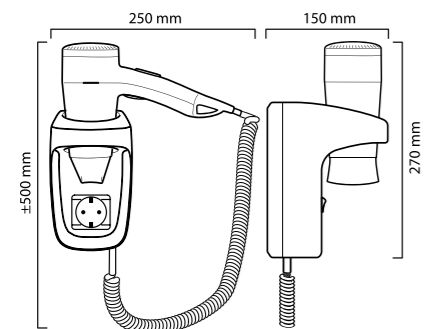
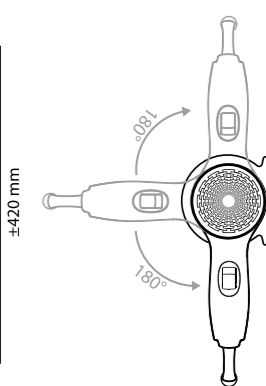

**MOD: 301001-301000-301101-301200**

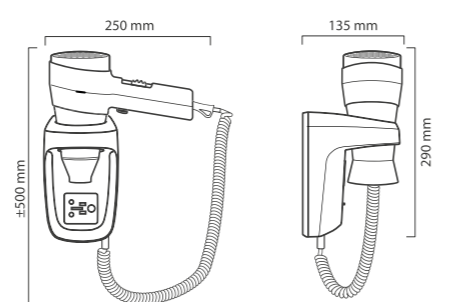
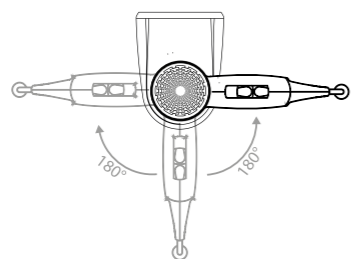

**MOD: 300805-300809**

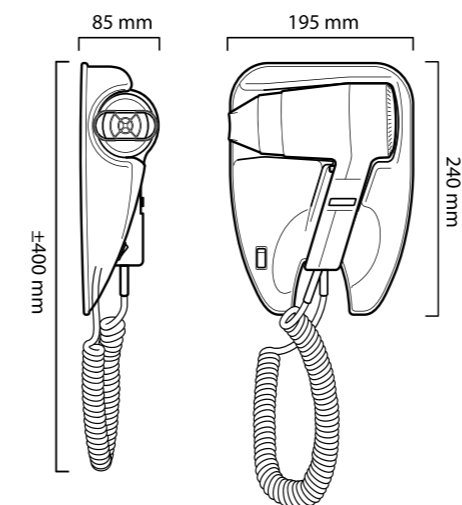
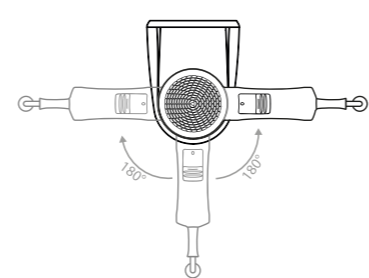

**MOD: 300600**

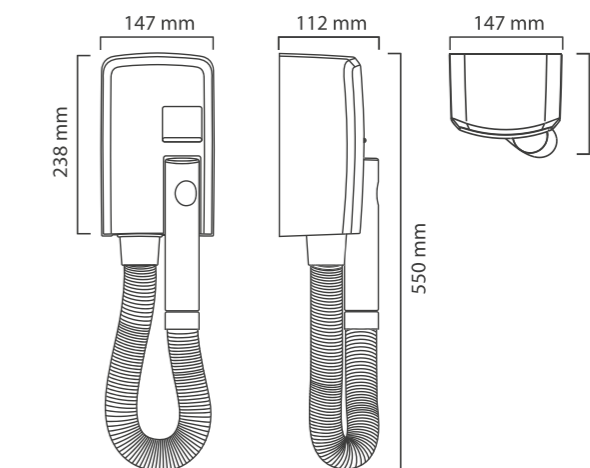

**MOD: 302900-302901-302903-302905-303000**

# SECADORES PISTOLA *hairdryers*



## ECO LINE 309500 (NEGRO/BALCK)



- Potencia: 1800 W.
- Motor alta calidad + 1000 h.
- Interruptor deslizante con 3 ajustes de temperatura de aire.
- Voltaje: 220-240V / 50 Hz.
- Flujo de aire: 75-105 m3/h.
- RPM: 16000-17000.
- Temperatura del aire 100° (± 5° a 21° temperatura ambiente).
- Nivel de ruido: 80 dB.
- Incluye 2 boquillas.
- Cable espiral.
- Power: 1800 W.
- High quality motor +1000 h.
- Slide switch with 3 air temperature settings.
- Voltage: 220-240V / 50 Hz.
- Airflow 75-105 m3/h.
- RPM 16000-17000.
- Air temperatura 100° (± 5° a 21° with ambient temperature).
- Noise level: 80 dB.
- 2 nozzles included.
- Spiral cable.



## SUSAN II 309501 (NEGRO MATE/MATTE BLACK)



- Potencia: 1800W
- Motor AC alta calidad + 1000 h.
- Interruptor deslizante con 3 ajustes de temperatura de aire.
- Voltaje: 220-240V / 50 Hz.
- Flujo de aire: 75-105 m3/h.
- RPM: 16000-17000.
- Temperatura del aire 100° (± 5° a 21° temperatura ambiente).
- Nivel de ruido: 80 dB.
- Incluye 2 boquillas.
- Cable espiral.
- Power: 1800 W.
- High quality AC motor +1000 h.
- Slide switch with 3 air temperature settings.
- Voltage: 220-240V / 50 Hz.
- Airflow 75-105 m3/h.
- RPM 16000-17000.
- Air temperatura 100° (± 5° a 21° with ambient temperature).
- Noise level: 80 dB.
- 2 nozzles included.
- Spiral cable.

# SECADORES PARED

## Wall hairdryers



**ECO 1200W**  
**306501 (BLANCO/WHITE)**



- Potencia: 1200 W.
- Fabricado en ABS de alta calidad.
- Interruptor deslizante con 2 ajustes de temperatura de aire.
- Voltaje: 230V - 50 Hz.
- Velocidad del aire: 12 m/s.
- Cable espiral.

- Power: 1200 W.
- Made of high quality ABS.
- Slide switch with 2 air temperature settings.
- Voltage: 230V - 50 Hz.
- Air speed: 12 m/s.
- Spiral cable.



**DRAWER 1200W**  
**306502 (BLANCO/WHITE)**



- Potencia: 1200 W. BLANCO
- Fabricado en ABS de alta calidad.
- Interruptor deslizante con 2 ajustes de temperatura de aire.
- Voltaje: 230 V / 60 Hz.
- Velocidad del aire: 12 m/s.
- Cable espiral.

- Power: 1200 W.
- Made of high quality ABS.
- Slide switch with 2 air temperature settings.
- Voltage: 230V - 60 Hz.
- Air speed: 12 m/s.
- Spiral cable.

**DRAWER 1500W**  
**306502-N (NEGRO MATE/MATTE BLACK)**

Igual que modelo DRAWER 1200W pero de 1500W, con enchufe para afeitadora y en negro mate.  
Same as model DRAWER 1200W but 1500W, with shaver socket and matte black.



**ECO 1800W**  
**306504 (BLANCO/WHITE)**



- Potencia: 1800 W.
- Interruptor deslizante con dos ajustes de temperatura de aire.
- Voltaje: 230 V- 50 Hz.
- Velocidad del aire: 21 m/s.
- Con botón de aire frío.
- Funciona cuando se descuelga del soporte.
- Motor silencioso y de larga duración.
- Con sistema de protección contra sobre calentamiento.
- Boquilla concentradora.

- Power: 1800 W.
- Slide switch with two air temperature settings.
- Voltage: 230 V- 50 Hz.
- Air speed: 21 m/s.
- With cold air trigger button.
- It works when it is taken off the stand.
- Quiet and long-lasting motor.
- With overheating protection system.
- Concentrator nozzle.



**ECO 1800W**  
**306504-N (NEGRO/ BLACK)**



- Potencia: 1800 W.
- Interruptor deslizante con dos ajustes de temperatura de aire.
- Voltaje: 230 V- 50 Hz.
- Velocidad del aire: 21 m/s.
- Con botón de aire frío.
- Funciona cuando se descuelga del soporte.
- Motor silencioso y de larga duración.
- Con sistema de protección contra sobre calentamiento.
- Boquilla concentradora.

- Power: 1800 W.
- Slide switch with two air temperature settings.
- Voltage: 230 V- 50 Hz.
- Air speed: 21 m/s.
- With cold air trigger button.
- It works when it is taken off the stand.
- Quiet and long-lasting motor.
- With overheating protection system.
- Concentrator nozzle.

Dos propuestas de planchas de pelo que elevan la experiencia de tus clientes al siguiente nivel.

Diseñadas con la última tecnología, con placas de turmalina cerámica, permiten un manejo cómodo y seguro y un look perfectamente moldeado.



Two hair straighteners that take your customers' experience to the next level. Designed with the latest technology, with ceramic tourmaline plates, they allow for comfortable, safe handling and a perfectly shaped look.

# PLANCHAS

## HAIR STRAIGHTENER

# PLANCHAS DE PELO

*hair  
straightener*



## SWISS'X PULSECARE 307010



- Sistema de frecuencia de pulsos con 200 controles de sensor por segundo para una gestión total de la temperatura.
- Regulación electrónica de la temperatura con 5 ajustes de 120°C a 230°C (250°F - 450°F).
- Diseño fino, redondeado y compacto con zona de enrollado del cabello caliente para rizos y ondas perfectamente moldeados.
- Tamaño de la placa: 24 x 90 mm, diámetro 36 mm.
- Puntas cool-touch aisladas térmicamente para un manejo cómodo y seguro.
- 5x revestimiento cerámico con turmalina para un alisado superior y más sano.
- Potente generador de iones para un peinado delicado, ideal para cabellos teñidos.
- Sistema de placas flotantes para un contacto perfecto y uniforme con el cabello.
- Calentamiento ultrarrápido, aviso de temperatura alcanzada y apagado automático después de 60 min.
- Thermocap: funda protectora de silicona termoaislante.
- Bolsa blanda termoaislante.
- Cable giratorio de 3 m.
- Pulse Frequency System with 200 sensor controls per second for total temperature management.
- Electronical temperature regulation with 5 settings from 120°C to 230°C (250°F – 450°F).
- Slim, rounded and compact design with hot hair-coiling case zone for perfectly shaped curls and waves.
- Plate size 24 x 90 mm, diameter 36 mm.
- Heat-insulated cool-touch tips for comfortable and safe handling.
- 5x ceramic coating with tourmaline for superior and healthier straightening.
- Powerful ions generator for delicate styling, ideal for coloured hair.
- Floating plates system for a perfect and uniform contact with the hair.
- Ultra-fast heat up, HOT advisor, auto shut-off after 60 min.
- Thermocap: thermo-insulating silicone protection cap.
- Thermo-insulating soft pouch.
- Swivel cord 3 m (10 ft.).



**SWISS'X THERMOFIT  
307011**



- Control adaptativo del calor para un equilibrio perfecto de la temperatura.
- Encendido/Apagado 230°C.
- Diseño delgado, redondeado y compacto con para rizos y ondas perfectamente moldeados rizos y ondas.
- Tamaño de la placa 24 x 90 mm, diámetro 36 mm.
- Puntas cool-touch aisladas térmicamente para un manejo cómodo y seguro.
- 5 x revestimiento cerámico con turmalina para un alisado superior y más sano.
- Sistema de placas flotantes para un contacto perfecto y uniforme con el cabello.
- Calentamiento ultrarrápido.
- Thermocap: tapa protectora de silicona termoaislante.
- Cable giratorio de 3 m.
- Adaptive Heat Control for perfect temperature balance.
- On/Off 230°C.
- Slim, rounded and compact design with hot hair-coiling case zone for perfectly shaped curls and waves.
- Plate size 24 x 90 mm, diameter 36 mm.
- Heat-insulated cool-touch tips for comfortable and safe handling.
- 5 x ceramic coating with tourmaline for superior and healthier straightening.
- Floating plates system for a perfect and uniform contact with the hair.
- Ultra-fast heat up.
- Thermocap: thermo-insulating silicone protection cap.
- Swivel cord 3 m (10 ft.).



**307106**

Soporte de pared de latón para plancha de pelo.  
Acabado: negro mate.  
Brass wall-mounted hair straightener holder.  
Finish: matte black.



**307105**

Soporte de pared de latón para plancha de pelo.  
Acabado: cromo brillo.  
Brass wall-mounted hair straightener holder.  
Finish: bright chrome.



**126169**

Soporte colgante de latón para plancha de pelo.  
Acabado: cromo brillo.  
Brass hanging hair straightener holder.  
Finish: bright chrome.



**126170**

Soporte colgante de latón para plancha de pelo.  
Acabado: blanco mate.  
Brass hanging hair straightener holder.  
Finish: matte white.



**126171**

Soporte colgante de latón para plancha de pelo.  
Acabado: negro mate.  
Brass hanging hair straightener holder.  
Finish: matte black.

La serie de *Centros de planchado* ofrece una amplia gama de tablas de planchar, diferentes modelos de planchas y soportes organizadores que facilitan su instalación en cualquier habitación, habitación, garantizándola comodidad y satisfacción de los clientes.



The *Ironing Centre* series offers a wide range of ironing boards, different models of irons and organiser stands that facilitate installation in any room, guaranteeing comfort and customer satisfaction.

## Centros de planchado

### *Ironing centres*

PLANCHAS Y SOPORTES	238
BLACK LINE PREMIUM	242
BLACK LINE	244
PABLO	245
CEPILLO DE VAPOR	246
OCEAN PREMIUM	250

# PLANCHAS

## Irons



### PLANCHA VAPOR BLACK LINE PREMIUM 400245

- Plancha de vapor con base de cerámica.
- Potencia: 2000 -2200 W.
- Voltaje: 220-240 V, 50-60 Hz.
- Dial de control de temperatura.
- Funciones: seco, vapor, cepillado de vapor, auto-limpieza, anti-cal, anti-derrame.
- Apagado automático:
  - En posición horizontal: 30 segundos.
  - En posición vertical: 8 minutos.
- Luz indicadora de temperatura.
- Depósito de agua: 320 ml.

### BLACK LINE PREMIUM STEAM IRON

- Steam iron with ceramic base.
- Power: 2000 -2200 W.
- Voltage: 220-240 V, 50-60 Hz.
- Temperature control dial.
- Functions: dry, steam, steambrushing, self-cleaning, anti-calc, anti-spill.
- Automatic shut-off:
  - In horizontal position: 30 seconds.
  - In vertical position: 8 minutes.
- Temperature indicator light.
- Watertank: 320 ml.



### PLANCHA EN SECO BLACK LINE 400311

- Plancha en seco.
- Potencia: 1000 W.
- Dial de control de temperatura.
- Protección de seguridad por sobrecalentamiento.
- Luz indicadora de temperatura.
- Suela antiadherente.
- Apagado automático:
  - En posición horizontal: 30 segundos.
  - En posición vertical: 8 minutos.
- Cable 1,8 m.

### BLACK LINE DRY IRON

- Dry iron.
- Power: 1000 W.
- Temperature control dial.
- Safety protection from overheating.
- Temperature indicator light.
- Non-sticksole.
- Automatic shut-off:
  - In horizontal position: 30 seconds.
  - In vertical position: 8 minutes.
- Cable: 1,8 m.



### SOPORTE ORGANIZADOR PARA TABLA 400233

- Soporte para tabla de planchar.
- Con gancho para colgar en el armario.
- Fabricado en acero inoxidable pintado y goma antideslizante resistente al calor.

### ORGANISER STAND FOR IRONING BOARD

- Ironing board holder.
- With hook for hanging in the wardrobe.
- Made of painted stainless steel and heat-resistant non-slip rubber.

450 x 145 x 170 mm.



### SOPORTE ORGANIZADOR PARA PLANCHA 400244

- Soporte organizador para plancha de vapor.
- Instalación en tabla de planchar.
- Sistema de seguridad antirrobo.
- Fácil de montar.
- Fijaciones: incluidas.

### ORGANISER STAND FOR TABLE

- Organiser stand for steam iron.
- Installation on ironing board.
- Anti-theft security system.
- Easy to assemble.
- Fixings: included.

200 x 220 x 180 mm.



# BLACK LINE PREMIUM

Centro de planchado completo:

- Plancha de vapor o en seco.
- Tabla de planchado con gancho.
- Soporte para plancha de vapor.

Complete ironing center:

- Steam or dry iron.
- Ironing board with hook.
- Steam iron stand.



## TABLA DE PLANCHAR BLACK LINE PREMIUM 400243

- Tabla de planchado.
- Funda de algodón con refuerzo de fieltro y esponja de 10 mm de espesor.
- Ajustable en altura (máx. 85 cm).
- Altura ajustable en 7 niveles.
- Incluye gancho para colgar en armario.

Desplegada: 850 x 1100 x 330 mm.

## BLACK LINE PREMIUM IRONING BOARD

- Ironing board.
- Cotton cover with felt reinforcement and 10 mm thick sponges.
- Height adjustable (max. 85 cm).
- Height adjustable in 7 levels.
- Includes hook for hanging in wardrobe.

Unfolded: 850 x 1100 x 330 mm.



## PLANCHA DE VAPOR BLACK LINE PREMIUM 400245

- Consultar características en página 240.

## BLACK LINE PREMIUM STEAM IRON

- See features on page 240.



## PLANCHA EN SECO BLACK LINE 400311

- Consultar características en página 240.

## BLACK LINE DRY IRON

- See features on page 240.



## SOPORTE ORGANIZADOR PARA PLANCHA 400244

- Consultar características en página 241.

## ORGANISER STAND FOR IRON

- See features on page 241.

# BLACK LINE

Centro de planchado completo:

- Plancha de vapor.
- Tabla de planchado con gancho.
- Soporte para plancha de vapor.

Complete ironing center:

- Steam iron.
- Ironing board with hook.
- Steam iron stand.



## TABLA DE PLANCHAR BLACK LINE 400229

- Tabla de planchado.
- Funda de algodón con refuerzo de fieltro y esponja de 10 mm de espesor.
- Ajustable en altura (máx. 85 cm).
- Altura ajustable en 7 niveles.
- Disponible con soporte de la plancha con gancho para colgar en el armario (no incluido).

Desplegada: 850 x 1100 x 330 mm.

## BLACK LINE PREMIUM IRONING BOARD

- Ironing board.
- Cotton cover with felt reinforcement and 10 mm thick sponges.
- Height adjustable (max. 85 cm).
- Height adjustable in 7 levels.
- Available with ironing board holder with hook for hanging in the wardrobe (not included).

Unfolded: 850 x 1100 x 330 mm.



## PLANCHA DE VAPOR BLACK LINE PREMIUM 400245

- Consultar características en página 240.

## BLACK LINE PREMIUM STEAM IRON

- See features on page 240.



## PLANCHA EN SECO BLACK LINE 400311

- Consultar características en página 240.

## BLACK LINE DRY IRON

- See features on page 240.



## SOPORTE ORGANIZADOR PARA TABLA 400233

- Consultar características en página 241.

## ORGANISER STAND FOR IRONING BOARD

- See features on page 241.

# PABLO



## TABLA DE PLANCHAR PABLO 400214-S

- Modelo de tabla muy compacto con gran superficie de planchado.
- Solo 4,5 cm de ancho cuando se guarda en el armario.
- Altura de planchado perfecta debido a la ubicación de la mesa.
- Soporte de hierro integrado para una colocación segura del hierro.
- Protectores de goma debajo para proteger los muebles.
- Mecanismo lógico de desplegado / plegado.
- Fácil de colocar, fácil de usar y fácil de almacenar.

Desplegada: 160 x 1000 x 310 mm.

## PABLO IRONING BOARD

- Very compact table model with large ironing surface.
- Only 4,5 cm wide when stored in the wardrobe.
- Perfect ironing height due to the table/desk placement.
- Integrated iron rest for safe iron placement.
- Rubber protectors underneath to protect the furniture.
- Logical unfolding / folding mechanism.
- Easy to place, easy to use and easy to store.

Unfolded: 160 x 1000 x 310 mm.

## COMPATIBLE CON: COMPATIBLE WITH:



## SOPORTE PARA PLANCHA LASER 400218

- Ahorro de espacio, fácil de colocar y fácil de usar.
- Se puede montar directamente en casi todas las superficies atornillables.
- También se puede usar solo como soporte para planchar.
- Inserciones de goma para evitar el deslizamiento.

## LASER ORGANISER FOR IRON

- Space saving, easy to fit and easy to use for housekeeping and guests
- Directly mountable on almost every screwable surface
- Can also be used as iron organiser only
- Rubber inserts to prevent sliding



# CEPILLO VAPOR



## CEPILLO DE VAPOR 400306

- Alimentación: 220V, 50/60Hz, 1500W.
- Temperatura vapor: 98°C.
- Calentador: aluminio.
- Capacidad tanque agua: 100 ml.
- Auto apagado por sobrecalentamiento o falta de agua.
- Peso Neto: 0.7 kg.
- VDE conexión.
- Color negro.

## STEAM BRUSH

- Power: 220V, 50/60Hz, 1500W.
- Steam temperature: 98°C.
- Heater: aluminium.
- Water tank capacity: 100 ml.
- Auto power off for over-heating or water shortage.
- Net weight: 0.7 kg.
- VDE plug.
- Black color.

180 x 145 x 75 mm.



## SOPORTE DE PARED 305200

- Fabricado en ABS.
- Acabado en negro mate.

## WALL HOLDER

- Made of ABS
- Finish: matte black.

# PLANCHAS

## Irons



### PLANCHA DE VAPOR 400300-S

- Potencia: 1800 W.
- Voltaje: 220-240 V, 50-60 Hz.
- Apagado automático:
  - En posición horizontal: 30 segundos.
  - En posición vertical: 15 minutos.
- Luz roja indicadora de temperatura.
- Suela de acero inoxidable antiadherente.
- Potente botón de golpe de vapor con función de rocío (70 g/min).
- Depósito de agua: 250 ml. (Incluye 2 envases de relleno).
- Cable antirrobo: 2.5 m.
- Fácil de guardar, con gancho suspendido, patentado para la plancha y colocación en el armario.

### STEAM IRON

- Power: 1600-2000 W.
- Voltage: 220-240 V, 50-60 Hz.
- Automatic switch-off:
  - In horizontal position: 30 seconds.
  - In vertical position: 8 minutes.
- Red "in use" indicator light.
- Non-stick soleplate.
- Powerful steam jet button with spray function (70 g/min).
- Water tank: 250 ml. (Includes 2 refill containers)
- Anti-theft cable: 2.5 m.
- Easy to store, with suspended, patented hook for ironing and cabinet placement.



### PLANCHA EN SECO 400300-D

- Potencia: 1100 W.
- Voltaje: 220-240 V, 50-60 Hz.
- Apagado automático:
  - En posición horizontal: 30 segundos.
  - En posición vertical: 8 minutos.
- Luz roja indicadora de temperatura.
- Suela de acero inoxidable antiadherente.
- Cable antirrobo: 2.5 m.
- Fácil de guardar, con gancho suspendido, patentado para la plancha y colocación en el armario.

### DRY IRON

- Power: 11100 W.
- Voltage: 220-240 V, 50-60 Hz.
- Automatic switch-off:
  - In horizontal position: 30 seconds.
  - In vertical position: 8 minutes.
- Red "in use" indicator light.
- Non-stick stainless steel soleplate.
- Anti-theft cable: 2.5 m.
- Easy to store, with suspended, patented hook for ironing and cabinet placement.



### PLANCHA DE VAPOR CON CABLE RETRÁCTIL 400305

- Potencia: 2200 W.
- Voltaje: 220-240 V, 50-60 Hz.
- Apagado automático:
  - En posición horizontal: 30 segundos.
  - En posición vertical: 8 minutos.
- Función antigoteo.
- Suela de cerámica antiadherente.
- Función de vapor y rociado.
- Depósito de agua: 250 ml.
- Cable retráctil: 1,95 m.
- Fácil de guardar gracias al cable retráctil.

### STEAM IRON RETRACTABLE

- Power: 2200 W.
- Voltage: 220-240 V, 50-60 Hz.
- Automatic switch-off:
  - In horizontal position: 30 seconds.
  - In vertical position: 8 minutes.
- Non-drip function.
- Nano-ceramic anti-scratch soleplate.
- Steam boost & spray function.
- Water tank: 250 ml.
- Retractable cable: 1.95 m.
- Easy to store, due to retractable cable.



### SOPORTE LASER CON GANCHO 400238

- Organizador y colgador de plancha integrado que ahorra espacio.
- Mantiene la superficie de planchado gracias al mecanismo giratorio.
- Fácil de usar.
- Inserciones de goma para evitar deslizamientos.
- Soporte de metal resistente y organizador de plástico resistente al calor.
- Se coloca en la parte superior de la tabla de planchar.
- Fácil de montar, tornillos incluidos.

### LASER ORGANISER WITH HOOK

- Space-saving integrated iron organiser and hanger.
- Maintains the ironing surface due to the swivel mechanism.
- Rubber inserts to prevent sliding.
- Bracket made of strong metal and organiser of heat resistant plastic.
- Positioned at the top of the ironing board.
- Easy to mount, screws included.



### SOPORTE LASER PARA PLANCHA 400218

- Ahorra espacio, fácil de colocar y fácil de usar para el servicio doméstico y los invitados.
- Se monta directamente en casi todas las superficies atornillables.
- También se puede utilizar sólo como organizador de planchas.
- Inserciones de goma para evitar deslizamientos.
- Fabricado en plástico duradero y resistente al calor.

### LASER ORGANISER FOR IRON

- Space-saving, easy to position and easy to use for housekeeping and guests.
- Mounts directly to almost all screwable surfaces.
- Can also be used as an iron organiser only.
- Rubber inserts to prevent slipping.
- Made of durable, heat-resistant plastic.



### SOPORTE BOTTOM PARA PLANCHA Y TABLA 400246

- Ahorro extra de espacio gracias a la colocación especial en la parte inferior.
- Sin pérdida de espacio para planchar gracias al espacio extra debajo del organizador.
- Inserciones de goma para evitar el deslizamiento de la plancha.
- Fabricado en metal duradero y plástico resistente al calor.
- Fácil de montar, tornillos incluidos.

### BOTTOM ORGANISER FOR IRON AND IRONING TABLE

- Extra space saving thanks to the special positioning at the bottom of the organizer.
- No loss of ironing space due to extra space underneath the organizer.
- Rubber inserts to prevent slipping of the iron.
- Made of durable metal and heat resistant plastic.
- Easy to assemble, screws included.

# OCEAN PREMIUM

Centro de planchado completo:

- Plancha de vapor o en seco.
- Tabla de planchado con gancho.
- Soporte para plancha de vapor.

Complete ironing center:

- Steam or dry iron.
- Ironing board with hook.
- Steam iron stand.



## TABLA DE PLANCHAR OCEAN PREMIUM 400240

- Tabla de planchado.
- Funda de algodón con refuerzo de fieltro y esponja de 10 mm de espesor.
- Ajustable en altura (máx. 75 cm).
- Altura ajustable en 7 niveles.
- Patas antideslizantes.

Desplegada: 750 x 1040 x 410 mm.

## OCEAN PREMIUM IRONING BOARD

- Ironing board.
- Cotton cover with felt reinforcement and 10 mm thick sponges.
- Height adjustable (max. 75 cm).
- Height adjustable in 7 levels.
- Non-slip feet.

Unfolded: 750 x 1040 x 410 mm.

COMPATIBLE CON:  
COMPATIBLE WITH:



PLANCHA DE VAPOR  
STEAM IRON  
400300-S



PLANCHA EN SECO  
DRY IRON  
400300-D



PLANCHA DE VAPOR CON  
CABLE RETRÁCTIL  
STEAM IRON RETRACTABLE  
400305



SOPORTE LASER CON  
GANCHO  
LASER ORGANISER  
WITH HOOK  
400238



SOPORTE PARA  
PLANCHA LASER  
LASER ORGANISER  
FOR IRON  
400218



SOPORTE BOTTOM PARA  
PLANCHA Y TABLA  
BOTTOM ORGANISER FOR  
IRON AND IRONING TABLE  
400246

Nuestra selección de complementos para la habitación y el baño está pensada para hacer la estancia de los huéspedes más cómoda y placentera.

Desde papeleras, amenities y banquetas hasta básculas, hervidores, bandejas de bienvenida, perchas y reposamaletas, ofrecemos todo lo necesario para completar el diseño de cada espacio en el hotel.

Seleccionamos productos de la mejor calidad, pensados para cubrir todas las necesidades del huésped y facilitar el día a día del hotel.

Diseño, calidad y confort en cada detalle.

*Our selection of room and bathroom accessories is designed to make your guests' stay more comfortable and pleasant.*

*From wastepaper baskets, amenities and stools to scales, kettles, welcome trays, hangers and luggage racks, we offer everything you need to complete the design of each space in the hotel.*

*We select products of the highest quality, designed to meet all the needs of the guest and facilitate the daily life of the hotel.*

*Design, quality and comfort in every detail.*

## Complementos Inroom

*Inroom complements*

PAPELERAS <i>WASTEBASKETS</i>	254	BANQUETAS <i>STOOLS</i>	286
HIGIENE <i>HIGIENIC</i>	260	BÁSCULAS <i>SCALES</i>	288
GAMA POLIPIEL <i>LEATHERETTE LINE</i>	262	PERCHAS <i>HANGERS</i>	290
HERVIDORES <i>KETTLES</i>	272	TENDEDORES <i>CLOTHESLINE</i>	296
REPOSAMALETAS <i>LUGGAGE RACKS</i>	280		



# PAPELERAS

## Wastebaskets



POLIPIEL  
LEATHER



### 501510

Papelera cuadrada.  
Acabado: negro.  
Material: polipiel.

Square wastebasket.  
Finish: black.  
Material: leatherette.

310 x 230 x 230 mm.



### 501512-W

Papelera cuadrada.  
Acabado: marrón oscuro.  
Material: polipiel.

Square wastebasket.  
Finish: dark brown.  
Material: leatherette.

310 x 230 x 230 mm.



### 501513-BL

Papelera cuadrada.  
Acabado: blanco.  
Material: polipiel.

Square wastebasket.  
Finish: white.  
Material: leatherette.

310 x 230 x 230 mm.

### CUBOS INTERIORES / INNER BUCKETS



### 501515-N

Cubilete interior para  
papelera cuadrada.  
Acabado: negro.  
Material: metal.

Inner bucket for  
square wastebasket.  
Finish: black.  
Material: metal.

300 x 230 x 230 mm.



### 501607 / 501608

Cubilete trapezoidal  
para doble separación.  
Acabado: negro / verde.  
Material: metal.

Trapezoidal beaker for  
double separation.  
Finish: black / green.  
Material: metal.

300 x 230 x 115 mm.



### 501211

Papelera doble cuerpo aro  
extraíble negro y forro vinilo.  
Acabado: negro.  
Material: metal y vinilo.

Wastebasket with double  
body, black removable ring  
and vinyl.  
Finish: black.  
Material: metal and vinyl.  
270 x 225 x 225 mm.



### 501210

Papelera doble cuerpo aro  
extraíble negro y forro vinilo.  
Acabado: blanco.  
Material: metal y vinilo.

Wastebasket with double  
body, black removable ring  
and vinyl.  
Finish: white.  
Material: metal and vinyl.  
270 x 225 x 225 mm.

### CUBO INTERIOR INNER BUCKET



### 501220

Cubilete interior verde  
para separación de  
residuos.  
Acabado: verde.  
Material: plástico.

Green inner bucket for  
waste separation.  
Finish: green.  
Material: plastic.  
250 x 103 x 205 mm.

250 x 103 x 205 mm.



### 501217

Papelera doble cuerpo.  
Acabado: ivory.  
Material: ABS y polipiel.

Double body wastebasket.  
Finish: ivory.  
Material: ABS and  
leatherette.  
298 x 228 x 228 mm.

298 x 228 x 228 mm.



### 501218

Papelera doble cuerpo.  
Acabado: gris piedra.  
Material: ABS y polipiel.

Double body wastebasket.  
Finish: stone.  
Material: ABS and leatherette.  
298 x 228 x 228 mm.

298 x 228 x 228 mm.

**POLIPIEL  
LEATHER**



**501506**  
Papelera forro vinilo.  
Acabado: negro.  
Material: ABS y vinilo.

Vinyl wastebasket.  
Finish: black.  
Material: ABS and vinyl.

380 x 250 x 250 mm.



**501507**  
Papelera forro vinilo.  
Acabado: blanco.  
Material: ABS y vinilo.

Vinyl wastebasket.  
Finish: white.  
Material: ABS and vinyl.

380 x 250 x 250 mm.



**501517**  
Papelera forro vinilo.  
Acabado: kaki claro.  
Material: ABS y vinilo.

Vinyl wastebasket.  
Finish: light khaki.  
Material: ABS and vinyl.

380 x 250 x 250 mm.



**501500**  
Papelera forro vinilo.  
Acabado: marrón.  
Material: ABS y vinilo.

Vinyl wastebasket.  
Finish: brown.  
Material: ABS and vinyl.

380 x 250 x 250 mm.



**501501**  
Papelera forro vinilo.  
Acabado: gris.  
Material: ABS y vinilo.

Vinyl wastebasket.  
Finish: grey.  
Material: ABS and vinyl.

380 x 250 x 250 mm.



**501214**  
Papelera ignífuga doble cuerpo antihuellas.  
Acabado: negro.  
Material: acero inoxidable y ABS.

Flame retardant bin with double body.  
Finish: black.  
Material: stainless steel and ABS.

298 x 228 x 228 mm.



**501518**  
Papelera tapa basculante.  
Acabado: negro.  
Material: acero inoxidable.

Wastepaper bin with hinged lid.  
Finish: black.  
Material: stainless steel.

300 x 200 x 200 mm.



**501519**  
Papelera reciclaje triselectiva.  
Acabado: negro.  
Material: acero inoxidable.

Triselective recycling bin.  
Finish: black.  
Material: stainless steel.

308 x 250 x 250 mm.



**501721**  
Papelera cuadrada con cubeta extraíble 14.5 L.  
Acabado: cromo brillo.  
Material: acero inoxidable.

Waste bin with removable inner bucket 14.5 L.  
Finish: bright chrome.  
Material: stainless steel.

320 x 220 x 220 mm.



**501721-N**  
Papelera cuadrada con cubeta extraíble 14.5 L.  
Acabado: negro mate.  
Material: acero inoxidable.

Waste bin with removable inner bucket 14.5 L.  
Finish: matte black.  
Material: stainless steel.

320 x 220 x 220 mm.

**METÁLICAS  
METALLIC**



**501705**  
Papelera redonda 10 L.  
Acabado: blanco.  
Material: acero inoxidable.

Waste bin-round 10 L.  
Finish: white.  
Material: stainless steel.

300 x 210 x 210 mm.



**501705-N**  
Papelera redonda 10 L.  
Acabado: negro.  
Material: acero inoxidable.

Waste bin-round 10 L.  
Finish: black.  
Material: stainless steel.

300 x 210 x 210 mm.



**501704**  
Papelera redonda 10 L.  
Acabado: brillo.  
Material: acero inoxidable.

Waste bin-round 10 L.  
Finish: bright.  
Material: stainless steel.

308 x 250 x 250 mm.



**501215**  
Papelera doble cuerpo 8 L.  
Acabado: beige.  
Material: ABS.

Double layer bin 8 L.  
Finish: beige.  
Material: ABS.

290 x 230 x 230 mm.



**501216**  
Papelera doble cuerpo 8 L.  
Acabado: negro.  
Material: ABS.

Double layer bin 8 L.  
Finish: black.  
Material: ABS.

290 x 230 x 230 mm.



**500905-N**  
Papelera para reciclado.  
Acabado: negro.  
Material: ABS.

Waste bin system.  
Finish: black.  
Material: ABS.

325 x 290 x 290 mm.



**6-500905-A/ 6-500905-AZ/ 6-500905-V**

Separador de reciclado.  
Acabado: amarillo/azul/verde.  
Material: ABS.

Divider for recycling for bin.  
Finish: yellow/blue/green.  
Material: ABS.



**501730**  
Papelera cuadrada.  
Acabado: brillo.  
Material: acero inoxidable.

Wall mounted square waste bin.  
Finish: bright.  
Material: stainless steel.

300 x 180 x 180 mm.



**501731**  
Papelera cuadrada.  
Acabado: satinado.  
Material: acero inoxidable.

Wall mounted square waste bin.  
Finish: satin.  
Material: stainless steel.

300 x 180 x 180 mm.



**501731-N**  
Papelera cuadrada.  
Acabado: negro mate.  
Material: acero inoxidable.

Wall mounted square waste bin.  
Finish: matte black.  
Material: stainless steel.

300 x 180 x 180 mm.



**6-20274-N-REDONDA**  
Papelera POLARIS redonda 10 L.  
Acabado: negro.  
Material: plástico.

Round POLARIS wastebasket 10 L.  
Finish: black.  
Material: plastic.

290 x 250 x 250 mm.



**6-20274-M-REDONDA**  
Papelera POLARIS redonda 10 L.  
Acabado: marron.  
Material: plástico.

Round POLARIS wastebasket 10 L.  
Finish: brown.  
Material: plastic.

290 x 250 x 250 mm.

# HIGIENE

## Higienic



### 503600/503602

Portabolsitas higiénicas.  
Acabado: cromo brillo/satinado.  
Material: ABS.

Sanitary bag dispenser.  
Finish: bright chrome/satin.  
Material: ABS.

137 x 97 x 27 mm.



### 503603/503604

Portabolsitas higiénicas.  
Acabado: blanco/negro.  
Material: ABS.

Sanitary bag dispenser.  
Finish: white/black.  
Material: ABS.

137 x 97 x 27 mm.



### 503700/503702

Portabolsitas higiénicas.  
Acabado: brillo/satinado.  
Material: acero inoxidable.

Sanitary bag dispenser.  
Finish: bright/satin.  
Material: stainless steel.

140 x 92 x 25 mm.



### 503700-A / 503702-A

Portabolsitas higiénicas eco.  
Acabado: brillo/satinado.  
Material: acero inoxidable.

Eco sanitary bag dispenser.  
Finish: bright/satin.  
Material: stainless steel.

145 x 110 x 38 mm.



### 503800/503802 503803/503804

Dispensador cubo toallitas.  
Acabado: cromo brillo/satinado/blanco/negro.  
Material: ABS.

Cube tissue box.  
Finish: bright chrome/satin/white/black.  
Material: ABS.

132 x 125 x 125 mm.



### 503900/503902 503903/503904

Portacleanex rectangular.  
Acabado: cromo brillo/satinado/blanco/negro.  
Material: ABS.

Rectangular tissue box.  
Finish: bright chrome/satin/white/black.  
Material: ABS.

60 x 256 x 140 mm.



### 502000/502002

Portacleanex rectangular.  
Acabado: brillo/satinado.  
Material: acero inoxidable.

Rectangular tissue box.  
Finish: bright/satin.  
Material: acero inoxidable.

60 x 270 x 143 mm.

# GAMA POLIPIEL HABITACIÓN- BAÑO

*Leatherette  
line for room-  
bathroom*



**506308**

Portacleanex rectangular.  
Acabado: negro.  
Material: polipiel.

Rectangular tissue box.  
Finish: black.  
Material: leatherette.

85 x 250 x 135 mm.



**506309**

Dispensador cubo toallitas.  
Acabado: negro.  
Material: polipiel.

Cube tissue box.  
Finish: black.  
Material: leatherette.

140 x 135 x 135 mm.



**506322**

Cubitera con pinzas.  
Acabado: negro.  
Material: polipiel.

Ice bucket with tongs.  
Finish: black.  
Material: leatherette.

180 x 140 x 140 mm.



**506319**

Bandeja sachet.  
Acabado: negro.  
Material: polipiel.

Sachet tray.  
Finish: black.  
Material: leatherette.

55 x 160 x 130 mm.



**506320**

Bandeja de servicio rectangular.  
Acabado: negro.  
Material: polipiel.

Rectangular serving tray.  
Finish: black.  
Material: leatherette.

30 x 400 x 200 mm.



**506321**

Bandeja de servicio cuadrada.  
Acabado: negro.  
Material: polipiel.

Square serving tray.  
Finish: black.  
Material: leatherette.

50 x 350 x 350 mm.



**506324**

Bandeja con cajón.  
Acabado: negro.  
Material: polipiel.

Tray with drawe.  
Finish: black.  
Material: leatherette.

80 x 300 x 200 mm.



**506324-XL**

Bandeja XL con cajón.  
Acabado: negro.  
Material: polipiel.

XL tray with drawer.  
Finish: black.  
Material: leatherette.

80 x 405 x 335 mm.



**506333**

Cargador inalámbrico multifunción.  
Acabado: negro.  
Material: polipiel.

Multifunctional charger.  
Finish: black.  
Material: leatherette.

135 x 160 x 135 mm.



**506330**

Revistero.  
Acabado: negro.  
Material: polipiel.

Magazine stand.  
Finish: black.  
Material: leatherette.

285 x 170 x 270 mm.



**506331**

Caja lavandería.  
Acabado: negro.  
Material: polipiel.

Laundry box.  
Finish: black.  
Material: leatherette.

150 x 480 x 350 mm.



**506335**

Portacleanex rectangular.  
Acabado: arena.  
Material: polipiel.

Rectangular tissue box.  
Finish: sand.  
Material: leatherette.

85 x 250 x 135 mm.



**506336**

Dispensador cubo toallitas.  
Acabado: arena.  
Material: polipiel.

Cube tissue box.  
Finish: sand.  
Material: leatherette.

140 x 135 x 135 mm.



**506340**

Cubitera con pinzas.  
Acabado: arena.  
Material: polipiel.

Ice bucket with tongs.  
Finish: sand.  
Material: leatherette.

180 x 140 x 140 mm.



**506337**

Bandeja sachet.  
Acabado: arena.  
Material: polipiel.

Sachet tray.  
Finish: sand.  
Material: leatherette.

55 x 160 x 130 mm.



**506334**

Caja devolución de zapatos.  
Acabado: negro.  
Material: polipiel.

Shoe return box.  
Finish: black.  
Material: leatherette.

160 x 400 x 280 mm.



**506332**

Joyero.  
Acabado: negro.  
Material: polipiel.

Stationery box.  
Finish: black.  
Material: leatherette.

40 x 350 x 150 mm.



**506368**

Cepillo largo calzado.  
Acabado: negro.  
Material: ABS.

Shoe brush.  
Finish: black.  
Material: ABS.

386 x 40 x 61 mm.



**506366**

Calzador largo.  
Acabado: negro.  
Material: ABS.

Shoe horn.  
Finish: black.  
Material: ABS.

386 x 40 x 36 mm.



**506338**

Bandeja de servicio rectangular.  
Acabado: arena.  
Material: polipiel.

Rectangular serving tray.  
Finish: sand.  
Material: leatherette.

30 x 400 x 200 mm.



**506339**

Bandeja de servicio cuadrada.  
Acabado: arena.  
Material: polipiel.

Square serving tray.  
Finish: sand.  
Material: leatherette.

50 x 350 x 350 mm.



**506341**

Bandeja con cajón.  
Acabado: arena.  
Material: polipiel.

Tray with drawe.  
Finish: sand.  
Material: leatherette.

80 x 300 x 200 mm.



**506341-XL**

Bandeja XL con cajón.  
Acabado: arena.  
Material: polipiel.

XL tray with drawer.  
Finish: sand.  
Material: leatherette.

80 x 405 x 335 mm.

**POLIPIEL**  
**LEATHER**



**506346**

Cargador inalámbrico multifunción.  
Acabado: arena.  
Material: polipiel.

Multifunctional charger.  
Finish: sand.  
Material: leatherette.

135 x 160 x 135 mm.



**506342**

Revistero.  
Acabado: arena.  
Material: polipiel.

Magazine stand.  
Finish: sand.  
Material: leatherette.

285 x 170 x 270 mm.



**506344**

Caja lavandería.  
Acabado: arena.  
Material: polipiel.

Laundry box.  
Finish: sand.  
Material: leatherette.

150 x 480 x 350 mm.



**503805**

Dispensador cubo tollitas.  
Acabado: gris piedra.  
Material: ABS y polipiel.

Cube tissue box.  
Finish: stone.  
Material: ABS and leatherette.

140 x 125 x 125 mm.



**503906**

Portacleanex rectangular.  
Acabado: gris piedra.  
Material: ABS y polipiel.

Square tissue box.  
Finish: stone.  
Material: ABS and leatherette.

75 x 205 x 125 mm.



**506364**

Jabonera.  
Acabado: negro.  
Material: ABS.

Soap dish.  
Finish: black.  
Material: ABS.

20 x 88 x 88 mm.



**506343**

Caja devolución de zapatos.  
Acabado: arena.  
Material: polipiel.

Shoe return box.  
Finish: sand.  
Material: leatherette.

160 x 400 x 280 mm.



**506345**

Joyero.  
Acabado: arena.  
Material: polipiel.

Stationery box.  
Finish: sand.  
Material: leatherette.

40 x 350 x 150 mm.



**506369**

Cepillo largo calzado.  
Acabado: gris.  
Material: ABS.

Shoe brush.  
Finish: grey.  
Material: ABS.

386 x 40 x 61 mm.



**506367**

Calzador largo.  
Acabado: gris.  
Material: ABS.

Shoe horn.  
Finish: grey.  
Material: ABS.

386 x 40 x 36 mm.



**506347**

Bandeja para vasos/ botellas.  
Acabado: gris piedra.  
Material: ABS y polipiel.

Tray for 2 bottles of water.  
Finish: stone.  
Material: ABS and leatherette.

20 x 185 x 100 mm.



**506348**

Bandeja para block notas.  
Acabado: gris piedra.  
Material: ABS y polipiel.

Tray for notes.  
Finish: stone.  
Material: ABS and leatherette.

20 x 170 x 115 mm.



**506349**

Bandeja de servicio.  
Acabado: gris piedra.  
Material: ABS y polipiel.

Serving tray.  
Finish: stone.  
Material: ABS and leatherette.

30 x 320 x 230 mm.



**506350**

Bandeja de bienvenida.  
Acabado: gris piedra  
Material: ABS y polipiel

Welcome tray.  
Finish: stone  
Material: ABS and leatherette.

35 x 395 x 265 mm.



**506351**

Bandeja sachet.  
Acabado: gris piedra.  
Material: ABS y polipiel.

Sachet tray.  
Finish: stone.  
Material: ABS and leatherette.

60 x 100 x 90 mm.



**506352**

Bandeja sachet alargada.  
Acabado: gris piedra.  
Material: ABS y polipiel.

Rectangular sachet tray.  
Finish: stone.  
Material: ABS and leatherette.

55 x 185 x 65 mm.



**506353**

Organizador mando a distancia.  
Acabado: gris piedra.  
Material: ABS y polipiel.

Remote control holder.  
Finish: stone.  
Material: ABS and leatherette.

90 x 100 x 120 mm.



**506354**

Dispensador cubo toallitas.  
Acabado: ivory.  
Material: ABS y polipiel.

Cube tissue box.  
Finish: ivory.  
Material: ABS and leatherette.

140 x 125 x 125 mm.



**506356**

Portacleanex rectangular.  
Acabado: ivory.  
Material: ABS y polipiel.

Square tissue box.  
Finish: ivory.  
Material: ABS and leatherette.

75 x 205 x 125 mm.



**506365**

Jabonera.  
Acabado: gris.  
Material: ABS.

Soap dish.  
Finish: grey.  
Material: ABS.

20 x 88 x 88 mm.



**506357**

Bandeja para vasos/ botellas.  
Acabado: ivory.  
Material: ABS y polipiel.

Tray for 2 bottles of water.  
Finish: ivory.  
Material: ABS and leatherette.

20 x 185 x 100 mm.



**506358**

Bandeja para block notas.  
Acabado: ivory.  
Material: ABS y polipiel.

Tray for notes.  
Finish: ivory.  
Material: ABS and leatherette.

20 x 170 x 115 mm.



**506359**

Bandeja de servicio.  
Acabado: ivory.  
Material: ABS y polipiel.

Serving tray.  
Finish: ivory.  
Material: ABS and leatherette.

30 x 320 x 230 mm.



**506360**

Bandeja de bienvenida.  
Acabado: ivory.  
Material: ABS y polipiel.

Welcome tray.  
Finish: ivory.  
Material: ABS and leatherette.

35 x 395 x 265 mm.

**POLIPIEL + ABS**  
**LEATHER + ABS**



**506361**  
Bandeja sachet.  
Acabado: ivory.  
Material: ABS y polipiel.

Sachet tray.  
Finish: ivory.  
Material: ABS and leatherette.

60 x 100 x 90 mm.



**506362**  
Bandeja sachet alargada.  
Acabado: ivory.  
Material: ABS y polipiel.

Rectangular sachet tray.  
Finish: ivory.  
Material: ABS and leatherette.

55 x 185 x 65 mm.



**506363**  
Organizador mando a distancia.  
Acabado: ivory.  
Material: ABS y polipiel.

Remote control holder.  
Finish: ivory.  
Material: ABS and leatherette.

90 x 100 x 120 mm.



**506314 / 506314-MT**  
Bandeja de servicio.  
Acabado: negro/negro mate.  
Material: acrílico.

Amenity tray.  
Finish: black/matte black.  
Material: acrylic.

25 x 300 x 105 mm.



**506316/506316-MT**  
Jabonera.  
Acabado: negro/negro mate.  
Material: acrílico.

Soap dish.  
Finish: black/matte black.  
Material: acrylic.

25 x 110 x 85 mm.



**506312**  
Algodonera.  
Acabado: negro mate.  
Material: acrílico.

Cotton container.  
Finish: matte black.  
Material: acrylic.

108 x 65 x 65 mm.



**503804**  
Dispensador cubo toallitas.  
Acabado: negro.  
Material: ABS.

Cube tissue box.  
Finish: black.  
Material: ABS.

132 x 125 x 125 mm.



**503904**  
Portacleanex rectangular.  
Acabado: negro.  
Material: ABS.

Rectangular tissue box.  
Finish: black.  
Material: ABS.

60 x 256 x 140 mm.



**506315/506315-MT**  
Bandeja de servicio.  
Acabado: blanco/blanco mate.  
Material: acrílico.

Amenity tray.  
Finish: white/matte white.  
Material: acrylic.

25 x 300 x 105 mm.



**506317/506317-MT**  
Jabonera.  
Acabado: blanco/blanco mate.  
Material: acrílico.

Soap dish.  
Finish: white/matte white.  
Material: acrylic.

25 x 110 x 85 mm.



**506313**  
Algodonera.  
Acabado: blanco mate.  
Material: acrílico.

Cotton container.  
Finish: matte white.  
Material: acrylic.

108 x 65 x 65 mm.



**503803**  
Dispensador cubo toallitas.  
Acabado: blanco.  
Material: ABS.

Cube tissue box.  
Finish: white.  
Material: ABS.

132 x 125 x 125 mm.



**503903**  
Portacleanex rectangular.  
Acabado: blanco.  
Material: ABS.

Rectangular tissue box.  
Finish: white.  
Material: ABS.

60 x 256 x 140 mm.



# HERVIDORES KETTLES



## HERVIDOR RETRO 506217

Capacidad: 0.6 L.  
Potencia: 1350 W.  
Termostato UK STRIX: triple protección de seguridad.  
Indicador de la temperatura del agua.  
Silbato recordatorio de ebullición.  
Selección de 3 temperaturas con botón táctil.  
Asa movable para transporte y llenado fácil.  
Sonda de detección de temperatura oculta.  
Acabado: negro mate.  
Material: acero inoxidable.  
240 x 200 x 175 mm.



## RETRO KETTLE

Capacity: 0.6 L.  
Power: 1350 W.  
UK STRIX thermostat: triple safety protection.  
Water temperature display.  
Boiling whistle reminder.  
Touch button, three temperature can be selected.  
Movable carrying handle, easy to add water.  
Hidden temperature sensing probe.  
Finish: matte black.  
Material: stainless steel.

## HERVIDOR SAFRON 505500

Capacidad: 1 L.  
Potencia: 1500 W.  
Rotación de 360° sobre la base.  
Luz indicadora de funcionamiento.  
Parada automática a temperatura de ebullición.  
Protector para no hervir en seco.  
Filtro de agua en la boquilla.  
Visor indicador de nivel de agua.  
Control Strix  
Acabado: satinado.  
Material: acero inoxidable.  
215 x 145 x 145 mm.



## SAFRON KETTLE

Capacity: 1 L.  
Power: 1500 W.  
360° rotation on the base.  
Operation indicator light.  
Automatic stop at boiling temperature.  
Protector to prevent boiling dry.  
Water filter in spout.  
Water level indicator.  
Full Strix controlled.  
Finish: satin.  
Material: stainless steel.



**HERVIDOR ECOCORAL  
506200-L/506209**

Capacidad: 0.5 L.  
Potencia: 800 W.  
Rotación de 360° sobre la base.  
Luz indicadora de funcionamiento.  
Parada automática a temperatura de ebullición.  
Protector para no hervir en seco.  
Acabado: satinado/negro mate.  
Material: acero inoxidable.  
195 x 205 x 140 mm.

**ECOCORAL KETTLE**

Capacity: 0.5 L.  
Power: 800 W.  
360° rotation on the base.  
Operation indicator light.  
Automatic stop at boiling temperature.  
Protector to prevent boiling dry.  
Finish: satin/matte black.  
Material: stainless steel.



**HERVIDOR PREMIUM  
505407**

Capacidad: 1 L.  
Potencia: 1000-1200 W.  
Rotación de 360° sobre la base.  
Luz indicadora de funcionamiento.  
Parada automática a temperatura de ebullición y vaciado.  
Acabado: satinado.  
Material: acero inoxidable.  
190 x 130 x 130 mm.

**PREMIUM KETTLE**

Capacity: 1 L.  
Power: 1000-1200 W.  
360° rotation base.  
Operating indicator light.  
Automatic switch-off when boiling or empty.  
Finish: satin.  
Material: stainless steel.



**HERVIDOR NAOMI  
505403/505406**

Capacidad: 0.8 L.  
Potencia: 1000 W.  
Rotación de 360° sobre la base.  
Parada automática a temperatura de ebullición.  
Protector para no hervir en seco.  
Acabado: negro/blanco.  
Material: plástico.  
210 x 200 x 140 mm.

**NAOMI KETTLE**

Capacity: 0.8 L.  
Power: 1000 W.  
360° rotation on the base.  
Automatic stop at boiling temperature.  
Protector to prevent boiling dry.  
Finish: black/white.  
Material: plastic.



**HERVIDOR NAOMI BASE  
CON CABLE RETRÁCTIL  
505410/505411**

Capacidad: 1 L.  
Potencia: 1200-1400 W.  
Rotación de 360° sobre la base.  
Parada automática a temperatura de ebullición.  
Protector para no hervir en seco.  
Acabado: satinado/negro mate.  
Material: acero inoxidable.  
200 x 180 x 130 mm.



**NAOMI KETTLE RETRACTIL  
CABLE**

Capacity: 1 L.  
Power: 1200-1400 W.  
360° rotation on the base.  
Automatic stop at boiling temperature.  
Protector to prevent boiling dry.  
Finish: satin/matte black.  
Material: stainless steel.



**HERVIDOR HALO PLUS  
506216/506215**

Capacidad: 0.8 L.  
Power: 1000-1200 W.  
Estructura doble cuerpo.  
Luz indicadora de funcionamiento.  
Parada automática a temperatura de ebullición.  
Protector para no hervir en seco.  
Tapa amplia.  
Acabado: negro mate/blanco mate.  
Material: acero inoxidable.  
200 x 120 x 180 mm.

**HALO PLUS KETTLE**

Capacity: 0.8 L.  
Power: 1000-1200 W.  
Double body structure.  
Operation indicator light.  
Automatic stop at boiling temperature.  
No boil-dry protector.  
Wide lid.  
Finish: matte black/matte white.  
Material: stainless steel.



**HERVIDOR BLACK LINE  
505401**

Capacidad: 1.2 L.  
Power: 1350 W.  
Rotación de 360° sobre la base.  
Luz indicadora de funcionamiento.  
Acabado: brillo.  
Material: acero inoxidable.  
215 x 145 x 145 mm.

**BLACK LINE KETTLE**

Capacity: 1.2 L.  
Power: 1350 W.  
360° rotation on base.  
Operation indicator light  
Finish: bright.  
Material: stainless steel.



**TAZA CANELLA  
506003**

Capacidad: 150 ml  
Acabado: negro.  
Material: melamina.  
86 x 72 x 90 mm.

**CANELLA CUP**

Capacity: 150 ml.  
Finish: black.  
Material: melamine.



**CONJUNTO XANTHIC  
ECOCORAL  
505600+506200-L**

Bandeja Xanthic XL  
Hervidor Ecocoral 0.5 L.  
Acabado: caoba.  
Material: madera.  
45 x 500 x 200 mm.

**SET XANTHIC ECOCORAL**

Xanthic XL Tray  
Ecocoral Kettle 0.5 L.  
Finish: mahogany.  
Material: wood.



**CONJUNTO ORANGE  
ECOCORAL  
506207+506200-L**

Bandeja Orange.  
Hervidor Ecocoral 0.5 L.  
Acabado: negro.  
Material: madera.  
40 x 240 x 240 mm.

**SET ORANGE ECOCORAL**

Orange Tray.  
Ecocoral Kettle 0.5 L.  
Finish: black.  
Material: wood.



**CONJUNTO ETERNITY  
506208+505407**

Bandeja Eternity.  
Hervidor Premium 1 L.  
Acabado: roble  
Material: madera.  
35 x 360 x 250 mm.

**SET ETERNITY**

Eternity Tray.  
Premium Kettle 1 L.  
Finish: oak  
Material: wood.



**CONJUNTO XANTHIC  
HALO PLUS  
505600+506216**

Bandeja Xanthic XL  
Hervidor Halo Plus 0.8 L.  
Acabado: caoba.  
Material: madera.  
46 x 500 x 200 mm.

**SET XANTHIC HALO PLUS**

Xanthic XL Tray  
Halo Plus Kettle Halo Plus 0.8 L.  
Finish: mahogany.  
Material: wood.



**CONJUNTO HALO PLUS  
506201+506215**

Bandeja para hervidor.  
Hervidor Halo Plus 0.8 L.  
Acabado: caoba.  
Material: madera.  
30 x 420 x 200 mm.

**SET HALO PLUS**

Kettle tray.  
Kettle Halo Plus 0.8 L.  
Finish: mahogany.  
Material: wood.



**CONJUNTO BLACK LINE  
505103-A+505303-A+505401**

Bandeja principal Black Line.  
Bandeja sachet Black Line.  
Hervidor Black Line 1.2 L.  
Acabado: negro mate.  
Material: ABS.  
23 x 385 x 308 mm.

**SET BLACK LINE**

Black Line main tray.  
Black Line sachet tray.  
Black Line kettle 1.2 L.  
Finish: matte black.  
Material: ABS.



**CONJUNTO NAOMI  
505404-A + 505405-A + 505403**

Bandeja principal Naomi.  
Bandeja sachet Naomi.  
Hervidor Naomi 0.8 L.  
Acabado: negro.  
Material: ABS.  
20 x 380 x 280 mm.

**SET NAOMI**

Naomi main tray.  
Naomi sachet tray.  
Naomi kettle 0.8 L.  
Finish: black.  
Material: ABS.



**CONJUNTO NAOMI**  
505404-A + 505405-A + 505410

Bandeja principal Naomi.  
Bandeja sachet Naomi.  
Hervidor Naomi 1 L.  
Acabado: negro.  
Material: melamina.  
20 x 380 x 280 mm.

**SET NAOMI**  
Naomi main tray.  
Naomi sachet tray.  
Naomi kettle 1 L.  
Finish: black.  
Material: melamine.



**CONJUNTO NAOMI**  
505404-A + 505405-A + 505411

Bandeja principal Naomi.  
Bandeja sachet Naomi.  
Hervidor Naomi 1 L.  
Acabado: caoba.  
Material: madera.  
20 x 380 x 280 mm.

**SET NAOMI**  
Naomi main tray.  
Naomi sachet tray.  
Naomi kettle 1 L.  
Finish: mahogany.  
Material: wood.



**CONJUNTO NESPRESSO**  
**GRIS PIEDRA**  
506350+506351

Bandeja de bienvenida.  
Bandeja sachet.

**SET NESPRESSO STONE**  
Welcome tray.  
Sachet tray.



**CONJUNTO NESPRESSO**  
**IVORY**  
506360 + 506361

Bandeja de bienvenida.  
Bandeja sachet.

**SET NESPRESSO IVORY**  
Welcome tray.  
Sachet tray.



**CONJUNTO HALO PLUS**  
**GRIS PIEDRA**  
506350+506347+506351+506216

Bandeja bienvenida.  
Bandeja para dos botellas/tazas.  
Bandeja sachet.  
Hervidor Halo Plus 0.8 L.

**SET HALO PLUS STONE**  
Welcome tray.  
Tray for two bottles/cups.  
Sachet tray.  
Halo Plus kettle 0.8 L..



**CONJUNTO HALO PLUS**  
**IVORY**  
506360+506357+506361+506216

Bandeja bienvenida.  
Bandeja para dos botellas/tazas.  
Bandeja sachet.  
Hervidor Halo 0.8 L.

**SET HALO PLUS IVORY**  
Welcome tray.  
Tray for two bottles/cups.  
Sachet tray.  
Halo kettle 0.8 L..



**CONJUNTO NESPRESSO**  
506306 + 506200-L

Bandeja bienvenida Nespresso.  
Hervidor Ecocoral 0.5 L.  
  
Acabado: haya.  
Material: madera.  
35 x 460 x 370 mm.

**SET NESPRESSO**  
Nespresso welcome tray.  
Ecocoral kettle 0.5 L.  
  
Finish: beech.  
Material: wood.



**CONJUNTO NESPRESSO**  
506318 + 505410

Bandeja bienvenida Nespresso.  
Hervidor Naomi 1 L. con cable retráctil  
Acabado: negro.  
Material: madera.  
35 x 460 x 370 mm.

**SET NESPRESSO**  
Nespresso welcome tray.  
Naomi kettle 1 L. retractil cable  
Finish: black.  
Material: wood.

# REPOSAMALETAS

## LUGGAGE RACKS



**504028**

Reposamaletas Sienna I.  
Acabado: madera natural.  
Material: madera.

Sienna I luggage rack.  
Finish: beech.  
Material: wood.

Abierto/Open: 555 x 600 x 540 mm.  
Plegado/Folded: 810 x 600 x 95 mm.



**504031**

Reposamaletas Sienna I.  
Acabado: wengue.  
Material: madera.

Sienna I luggage rack.  
Finish: wengue.  
Material: wood.

Abierto/Open: 555 x 600 x 540 mm.  
Plegado/Folded: 810 x 600 x 95 mm.



**504032**

Reposamaletas Sienna I.  
Acabado: negro.  
Material: madera.

Sienna I luggage rack.  
Finish: black.  
Material: wood.

Abierto/Open: 555 x 600 x 540 mm.  
Plegado/Folded: 810 x 600 x 95 mm.



**504021**

Reposamaletas Sienna II.  
Acabado: madera natural.  
Material: madera.

Sienna II luggage rack.  
Finish: beech.  
Material: wood.

Abierto/Open: 620 x 600 x 585 mm.  
Plegado/Folded: 840 x 600 x 95 mm.



**504030**

Reposamaletas Sienna II.  
Acabado: wengue.  
Material: madera.

Sienna II luggage rack.  
Finish: wengue.  
Material: wood.

Abierto/Open: 620 x 600 x 585 mm.  
Plegado/Folded: 840 x 600 x 95 mm.



**504019**

Reposamaletas Sienna II.  
Acabado: negro.  
Material: madera.

Sienna II luggage rack.  
Finish: black.  
Material: wood.

Abierto/Open: 620 x 600 x 585 mm.  
Plegado/Folded: 840 x 600 x 95 mm.



**504014**  
Reposamaletas Grand Collection.  
Acabado: haya.  
Material: madera.

Grand collection luggage rack.  
Finish: beech.  
Material: wood.

Abierto/Open: 420 x 600 x 460 mm.  
Plegado/Folded: 600 x 600 x 70 mm.



**504017**  
Reposamaletas Grand Collection.  
Acabado: blanco.  
Material: madera.

Grand collection luggage rack.  
Finish: white.  
Material: wood.

Abierto/Open: 420 x 600 x 460 mm.  
Plegado/Folded: 600 x 600 x 70 mm.



**504015**  
Reposamaletas Grand Collection.  
Acabado: wengue.  
Material: madera.

Grand collection luggage rack.  
Finish: wengue.  
Material: wood.

Abierto/Open: 420 x 600 x 460 mm.  
Plegado/Folded: 600 x 600 x 70 mm.



**504020**  
Reposamaletas Excellence.  
Acabado: brillo y gris.  
Material: acero inoxidable.

Excellence luggage rack.  
Finish: bright and grey.  
Material: stainless steel.

Abierto/Open: 530 x 610 x 430 mm.  
Plegado/Folded: 680 x 610 x 30 mm.



**504020-N**  
Reposamaletas Excellence.  
Acabado: negro mate y marrón.  
Material: acero inoxidable.

Excellence luggage rack..  
Finish: matte black and brown.  
Material: stainless steel.

Abierto/Open: 530 x 610 x 430 mm.  
Plegado/Folded: 680 x 610 x 30 mm.



**504012**  
Reposamaletas cuadrado Avant.  
Acabado: cromo brillo.  
Material: acero inoxidable.

Avant square folding luggage rack.  
Finish: bright chrome.  
Material: stainless steel.

Abierto/Open: 570 x 560 x 420 mm.  
Plegado/Folded: 700 x 560 x 45 mm.



**504011**  
Reposamaletas Cubik sin respaldo.  
Acabado: cromo brillo.  
Material: acero inoxidable.

Cubik luggage rack.  
Finish: bright chrome.  
Material: stainless steel.

Abierto/Open: 715 x 680 x 480 mm.  
Plegado/Folded: 854 x 680 x 110 mm.



**504006**  
Reposamaletas con respaldo.  
Acabado: cromo brillo.  
Material: acero inoxidable.

Luggage rack with backrest.  
Finish: bright chrome.  
Material: stainless steel.

Abierto/Open: 715 x 680 x 480 mm.  
Plegado/Folded: 854 x 680 x 110 mm.



**504000-N** ● ●  
Reposamaletas.  
Acabado: cromo brillo / negro mate  
Material: acero inoxidable.

Luggage rack.  
Finish: bright chrome / matte black.  
Material: stainless steel.

Abierto/Open: 520 x 680 x 420 mm.  
Plegado/Folded: 655 x 680 x 110 mm.

## SUSAN COLLECTION



Abierto/Open: 530 x 610 x 430 mm. | Plegado/Folded: 680 x 610 x 30 mm.

Reposamaletas combinable, elige estructura y base.  
Combinable luggage rack, choose structure and base.

Estructura para reposamaletas.  
Material: acero inoxidable.  
Structure for luggage rack.  
Material: stainless steel.

### 504024

Acabado: negro.  
Finish: black.

### 504026

Acabado: oro mate.  
Finish: matte gold.

### 504029

Acabado: oro viejo.  
Finish: old gold.

Polipiel para reposamaletas.  
Material: polipiel.  
Leatherette for luggage rack.  
Material: leatherette.

### 504024-PC

Acabado: camel.  
Finish: camel.

### 504024-PM

Acabado: marrón.  
Finish: brown.

### 504027

Acabado: negro.  
Finish: black.



# BANQUETAS STOOLS



## 503000

Banqueta.  
Acabado: brillo.  
Material: acero inoxidable.

Bath stool.  
Finish: bright.  
Material: stainless steel.

410 x 280 x 280 mm.



## 503000-N

Banqueta.  
Acabado: negro mate.  
Material: acero inoxidable.

Bath stool.  
Finish: matte black.  
Material: stainless steel.

410 x 280 x 280 mm.



## 503100

Banqueta.  
Acabado: blanco.  
Material: ABS.

Bath stool.  
Finish: white.  
Material: ABS.

400 x 320 x 320 mm.



## 503001

Banqueta classic.  
Acabado: cromo brillo y blanco.  
Material: acero y madera MDF.

Classic bath stool.  
Finish: bright chrome and white.  
Material: steel y wood MDF.

425 x 320 x 320 mm.

# BÁSCULAS SCALES



## 506403

Báscula electrónica Snow.  
Acabado: blanco.  
Material: vidrio templado.

Snow electronic scale.  
Finish: white.  
Material: tempered glass.

25 x 305 x 247 mm.



## 506404

Báscula electrónica Naomi.  
Acabado: negro.  
Material: vidrio templado..

Naomi electronic scale.  
Finish: black.  
Material: tempered glass.

27 x 285 x 312 mm.



## 506405

Báscula electrónica Cindy sin batería.  
Acabado: negro.  
Material: vidrio templado.

Cindy electronic scale.  
Finish: black.  
Material: tempered glass.

25 x 320 x 260 mm.



## 506700-NEW

Báscula digital ultra plana.  
Acabado: blanco.  
Material: vidrio templado.

Ultra thin digital scale.  
Finish: white.  
Material: tempered glass.

19 x 300 x 300 mm.

# PERCHAS HANGERS



## 700900

Percha madera gancho normal y pinzas metálicas.  
Acabado: madera natural.  
Material: madera.

Wooden hanger with metal clips.  
Finish: beech.  
Material: wood.

265 x 450 x 12 mm.



## 701100

Percha madera gancho antirrobo y pinzas metálicas.  
Acabado: madera natural.  
Material: madera.

Wooden security hanger with metal clips.  
Finish: beech.  
Material: wood.

250 x 450 x 12 mm.

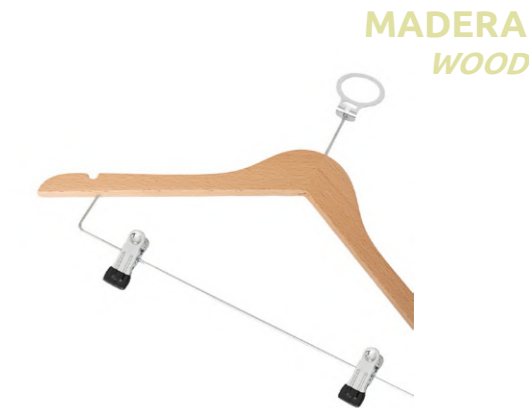

## 701100 + 700200

Percha de madera gancho antirrobo, anilla antirrobo metálica y pinzas metálicas.

Wooden security hanger with metal clips and anti-theft metal ring

265 x 450 x 12 mm.



## 701200

Percha madera gancho normal.  
Acabado: madera natural.  
Material: madera.

Wooden hanger with hook.  
Finish: beech.  
Material: wood.

225 x 445 x 12 mm.



## 701400

Percha madera gancho antirrobo.  
Acabado: madera natural.  
Material: madera.

Wooden security hanger.  
Finish: beech.  
Material: wood.

215 x 440 x 12 mm.



## 701400 + 700200

Percha de madera gancho antirrobo con anilla antirrobo metálica.

Wooden security hanger with anti-theft metal ring.

225 x 445 x 12 mm.

Disponibles otros acabados especiales. Perchas de madera personalizables con grabado láser.  
Other special finishes are available. Customisable wooden hangers with laser engraving.

**MADERA**  
WOOD



**701413-N**

Percha madera gancho normal y pinzas metálicas.  
Acabado: negro.  
Material: madera.

Wooden hanger with metal clips.  
Finish: black.  
Material: wood.

235 x 450 x 14 mm.



**701411-N**

Percha madera gancho antirrobo y pinzas metálicas.  
Acabado: negro.  
Material: madera.

Wooden security hanger with metal clips.  
Finish: black.  
Material: wood.

220 x 450 x 14 mm.



**701411-N + 700200**

Percha de madera gancho antirrobo con anilla antirrobo metálica y pinzas metálicas.

Wooden security hanger with metal clips and anti-theft metal ring.

235 x 450 x 14 mm.



**701412-N**

Percha madera gancho normal.  
Acabado: negro.  
Material: madera.

Wooden hanger with hook.  
Finish: black.  
Material: wood.

225 x 450 x 14 mm.



**701401-N**

Percha madera gancho antirrobo.  
Acabado: negro.  
Material: madera.

Wooden security hanger.  
Finish: black.  
Material: wood.

185 x 400 x 14 mm.



**701401-N + 700200**

Percha de madera gancho antirrobo con anilla antirrobo metálica.

Wooden security hanger with anti-theft metal ring.

225 x 450 x 14 mm.

**PLÁSTICO**  
PLASTICO



**700301**

Percha plástico gancho normal y pinzas metálicas.  
Acabado: negro.  
Material: plástico.

Plastic hanger with metal clips.  
Finish: black.  
Material: plastic.

245 x 440 x 22 mm.



**700501**

Percha plástico gancho antirrobo y pinzas metálicas.  
Acabado: negro.  
Material: plástico.

Plastic security hanger with metal clips.  
Finish: black.  
Material: plastic.

215 x 440 x 26 mm.



**700501 + 700200**

Percha plástico gancho antirrobo con pinzas metálicas y anilla antirrobo metálica.

Plastic hanger with anti-theft hook with metal clips and metal anti-theft ring.

245 x 440 x 26 mm.



**700601**

Percha plástico gancho normal.  
Acabado: negro.  
Material: plástico.

Plastic hanger with hook.  
Finish: black.  
Material: plastic.

220 x 440 x 40 mm.



**700801**

Percha plástico gancho antirrobo.  
Acabado: negro.  
Material: plástico.

Plastic security hanger.  
Finish: black.  
Material: plastic.

200 x 440 x 40 mm.



**700801 + 700200**

Percha plástico gancho antirrobo con anilla antirrobo metálica.

Plastic hanger with anti-theft hook and metal anti-theft ring.

220 x 440 x 40 mm.

Disponibles otros acabados especiales. Perchas de madera personalizables con grabado láser.  
Other special finishes are availables. Customisable wooden hangers with laser engraving.

**701001**

Percha cruz.  
Acabado: madera natural.  
Material: madera.

Cross hanger.  
Finish: beech.  
Material: wood.

640 x 450 x 16 mm.

**701001-N**

Percha cruz.  
Acabado: negro mate.  
Material: madera.

Cross hanger.  
Finish: matte black.  
Material: wood.

640 x 540 x 16 mm.

**700100**

Anilla antirrobo plástico D.30 mm interior.  
Acabado: negro.  
Material: plástico.

Anti-theft plastic ring ø30 mm.  
Finish: black.  
Material: plastic.

61 x 37 x 13 mm.

**700200**

Anilla antirrobo. D. 38 mm interior.  
Acabado: satinado.  
Material: acero.

Anti-theft ring D. 38 mm interior.  
Finish: satin.  
Material: steel.

62 x 50 x 15 mm.



# TENDEDORES CLOTHESLINE



## 507200/ 507202

Tendedor 70 cm.  
Acabado: brillo/ satinado.  
Material: acero inoxidable.

Wall mounted clothes drying rack.  
Finish: bright/ satin.  
Material: stainless steel.

45 x 730 x 225 mm.



## 507200-N

Tendedor 70 cm.  
Acabado: negro.  
Material: acero inoxidable.

Wall mounted clothes drying rack.  
Finish: black.  
Material: stainless steel.

45 x 730 x 225 mm.



## 507500/ 507502/ 507508/ 507500-N

Tendedor 4 barras giratorias 45 cm.  
Acabado: brillo/ satinado/ blanco/ negro.  
Material: acero inoxidable.

Horizontal drying rack 4 bars 45 cm.  
Finish: bright/ satin/ white/ black.  
Material: stainless steel.

210 x 450 x 450 mm.



## 507300/ 507302

Tendedor elevable 70 cm.  
Acabado: brillo/ satinado.  
Material: acero inoxidable.

Folding wall mount clothes drying rack.  
Finish: bright/ satin.  
Material: stainless steel.

135 x 700 x 340 mm.



## 507100

Tendedor telepack 70 cm.  
Acabado: blanco.  
Material: aluminio.

Telescoping wall mount clothes drying rack.  
Finish: white.  
Material: aluminium.

75 x 700 x 390 mm.



## 507000

Tendedor extensible bañera.  
Acabado: cromo brillo.  
Material: acero inoxidable.

Bath retractable clothesline.  
Finish: bright chrome.  
Material: stainless steel.

95 x 95 x 55 mm.

Nuestra selección de complementos para la habitación y el baño está pensada para hacer la estancia de los huéspedes más cómoda y placentera.

Desde papeleras, amenities y banquetas hasta básculas, hervidores, bandejas de bienvenida, perchas y reposamaletas, ofrecemos todo lo necesario para completar el diseño de cada espacio en el hotel.

Seleccionamos productos de la mejor calidad, pensados para cubrir todas las necesidades del huésped y facilitar el día a día del hotel.

Diseño, calidad y confort en cada detalle.

*Our selection of room and bathroom accessories is designed to make your guests' stay more comfortable and pleasant.*

*From wastepaper baskets, amenities and stools to scales, kettles, welcome trays, hangers and luggage racks, we offer everything you need to complete the design of each space in the hotel.*

*We select products of the highest quality, designed to meet all the needs of the guest and facilitate the daily life of the hotel.*

*Design, quality and comfort in every detail.*



## Complementos Outroom

*Outroom complements*

SECAMANOS 300  
HAND DRYERS

DISPENSADORES 304  
DISPENSERS

CAMBIAPAÑALES Y 312  
COMPRESEROS  
BABY CHANGING TABLES  
AND SANITARY PEDAL

PAPELERAS 314  
TRASH

CARROS DE LIMPIEZA 320  
CLEANING TROLLEYS

# SECAMANOS

## Hand dryers



### SECAMANOS MURAL 306601-HEPA

Secamanos de alta velocidad con filtro HEPA.  
Potencia: 1850 W.  
Sistema de detección de manos interior.  
Sistema de detección de salida de manos para parada de funcionamiento.  
Iluminación LED durante el secado.  
Bandeja extraíble recoge agua con filtro de partículas.  
Alimentación 230v/50Hz.  
Velocidad del aire: 95 m/s.  
Tiempo de secado: 6-9 s.  
Acabado: blanco.  
Material: ABS.

### MURAL HAND DRYER

High-speed hand dryer with HEPA filter.  
Power: 1850 W.  
Interior hand detection system.  
Hand exit detection system to stop operation.  
LED lighting during drying.  
Removable water collection tray with particle filter.  
Power supply 230v/50Hz.  
Air speed: 95 m/s.  
Drying time: 6-9 s.  
Finish: white.  
Material: ABS.

695 x 295 x 225 mm.



### SECAMANOS MURAL 306603-HEPA

Secamanos de alta velocidad con filtro HEPA.  
Potencia: 1850 W.  
Sistema de detección de manos interior.  
Sistema de detección de salida de manos para parada de funcionamiento.  
Iluminación LED durante el secado.  
Bandeja extraíble recoge agua con filtro de partículas.  
Alimentación 230v/50Hz.  
Velocidad del aire: 95 m/s.  
Tiempo de secado: 6-9 s.  
Acabado: satinado.  
Material: ABS.

### MURAL HAND DRYER

High-speed hand dryer with HEPA filter.  
Power: 1850 W.  
Interior hand detection system.  
Hand exit detection system to stop operation.  
LED lighting during drying.  
Removable water collection tray with particle filter.  
Power supply 230v/50Hz.  
Air speed: 95 m/s.  
Drying time: 6-9 s.  
Finish: satin.  
Material: ABS.

695 x 295 x 225 mm.



### SECAMANOS MURAL 306612-HEPA

Secamanos de alta velocidad con filtro HEPA.  
Potencia: 1850 W.  
Sistema de detección de manos interior.  
Sistema de detección de salida de manos para parada de funcionamiento.  
Iluminación LED durante el secado.  
Bandeja extraíble recoge agua con filtro de partículas.  
Alimentación 230v/50Hz.  
Velocidad del aire: 95 m/s.  
Tiempo de secado: 6-9 s.  
Acabado: negro mate.  
Material: ABS.

### MURAL HAND DRYER

High-speed hand dryer with HEPA filter.  
Power: 1850 W.  
Interior hand detection system.  
Hand exit detection system to stop operation.  
LED lighting during drying.  
Removable water collection tray with particle filter.  
Power supply 230v/50Hz.  
Air speed: 95 m/s.  
Drying time: 6-9 s.  
Finish: matte black.  
Material: ABS.

695 x 295 x 225 mm.



**SECAMANOS ÓPTICO VENDAVAL  
VENDAVAL OPTICAL HAND DRYER  
306700**

Potencia: 2500 W.  
Alimentación: 230v/50Hz.  
Velocidad del aire: 270 m3/h.  
Tiempo de secado: 30-40 s.  
Funcionamiento por sensor de infrarrojos.  
Acabado: blanco.  
Material: acero inoxidable.

Power: 2500 W.  
Power supply: 230v/50Hz.  
Air speed: 270 m3/h.  
Drying time: 30-40 s.  
Infrared sensor operation.  
Finish: white.  
Material: stainless steel.

240 x 265 x 210 mm.



**SECAMANOS ÓPTICO VENDAVAL  
VENDAVAL OPTICAL HAND DRYER  
306701**

Potencia: 2500 W.  
Alimentación: 230v/50Hz.  
Velocidad del aire: 270 m3/h.  
Tiempo de secado: 30-40 s.  
Funcionamiento por sensor de infrarrojos.  
Acabado: cromo brillo.  
Material: acero inoxidable.

Power: 2500 W.  
Power supply: 230v/50Hz.  
Air speed: 270 m3/h.  
Drying time: 30-40 s.  
Infrared sensor operation.  
Finish: bright chrome.  
Material: stainless steel.

240 x 265 x 210 mm.



**SECAMANOS CIERZO  
CIERZO HAND DRYER  
306604**

Potencia: 1650 W.  
Alimentación: 230v/50Hz.  
Velocidad del aire: 11 m/s.  
Tiempo de secado: 40-50 s.  
Funcionamiento por sensor de infrarrojos.  
Acabado: blanco.  
Material: ABS.

Power: 1650 W.  
Power supply: 230v/50Hz.  
Air speed: 11 m/s.  
Drying time: 40-50 s.  
Infrared sensor operation.  
Finish: white.  
Material: ABS.

285 x 220 x 147 mm.



**SECAMANOS CIERZO  
CIERZO HAND DRYER  
306605**

Potencia: 1650 W.  
Alimentación: 230v/50Hz.  
Velocidad del aire: 11 m/s.  
Tiempo de secado: 40-50 s.  
Funcionamiento por sensor de infrarrojos.  
Acabado: cromo brillo.  
Material: acero inoxidable.

Power: 1650 W.  
Power supply: 230v/50Hz.  
Air speed: 11 m/s.  
Drying time: 40-50 s.  
Infrared sensor operation.  
Finish: bright chrome.  
Material: stainless steel.

285 x 220 x 147 mm.



**SECAMANOS ÓPTICO VENDAVAL  
VENDAVAL OPTICAL HAND DRYER  
306702**

Potencia: 2500 W.  
Alimentación: 230v/50Hz.  
Velocidad del aire: 270 m3/h.  
Tiempo de secado: 30-40 s.  
Funcionamiento por sensor de infrarrojos.  
Acabado: satinado.  
Material: acero inoxidable.

Power: 2500 W.  
Power supply: 230v/50Hz.  
Air speed: 270 m3/h.  
Drying time: 30-40 s.  
Infrared sensor operation.  
Finish: satin.  
Material: stainless steel.

240 x 265 x 210 mm.



**SECAMANOS ÓPTICO VENDAVAL  
VENDAVAL OPTICAL HAND DRYER  
306701-N**

Potencia: 2500 W.  
Alimentación: 230v/50Hz.  
Velocidad del aire: 270 m3/h.  
Tiempo de secado: 30-40 s.  
Funcionamiento por sensor de infrarrojos.  
Acabado: negro mate.  
Material: acero inoxidable.

Power: 2500 W.  
Power supply: 230v/50Hz.  
Air speed: 270 m3/h.  
Drying time: 30-40 s.  
Infrared sensor operation.  
Finish: matte black.  
Material: stainless steel.

240 x 265 x 210 mm.



**SECAMANOS CIERZO  
CIERZO HAND DRYER  
306606**

Potencia: 1650 W.  
Alimentación: 230v/50Hz.  
Velocidad del aire: 11 m/s.  
Tiempo de secado: 40-50 s.  
Funcionamiento por sensor de infrarrojos.  
Acabado: satinado.  
Material: acero inoxidable.

Power: 1650 W.  
Power supply: 230v/50Hz.  
Air speed: 11 m/s.  
Drying time: 40-50 s.  
Infrared sensor operation.  
Finish: satin.  
Material: stainless steel.

285 x 220 x 147 mm.



**SECAMANOS CIERZO  
CIERZO HAND DRYER  
306610**

Potencia: 1650 W.  
Alimentación: 230v/50Hz.  
Velocidad del aire: 11 m/s.  
Tiempo de secado: 40-50 s.  
Funcionamiento por sensor de infrarrojos.  
Acabado: negro mate.  
Material: ABS.

Power: 1650 W.  
Power supply: 230v/50Hz.  
Air speed: 11 m/s.  
Drying time: 40-50 s.  
Infrared sensor operation.  
Finish: matte black.  
Material: ABS.

285 x 220 x 147 mm.

# DISPENSADORES

## Dispensers



**502300**

Dosificador de jabón vertical 1 L.  
Acabado: cromo brillo.  
Material: acero inoxidable.

Vertical soap dispenser 1 L.  
Finish: bright chrome.  
Material: stainless steel.

205 x 125 x 120 mm.



**502302**

Dosificador de jabón vertical 1 L.  
Acabado: satinado.  
Material: acero inoxidable.

Vertical soap dispenser 1 L.  
Finish: satin.  
Material: stainless steel.

205 x 125 x 120 mm.



**502300-N**

Dosificador de jabón vertical 1 L.  
Acabado: negro mate.  
Material: acero inoxidable.

Vertical soap dispenser 1 L.  
Finish: matte black.  
Material: stainless steel.

205 x 125 x 120 mm.



**502400**

Dosificador de jabón vertical 0.5 L.  
Acabado: cromo brillo.  
Material: acero inoxidable.

Vertical soap dispenser 0.5 L.  
Finish: bright chrome.  
Material: stainless steel.

150 x 100 x 115 mm.



**502402**

Dosificador de jabón vertical 0.5 L.  
Acabado: satinado.  
Material: acero inoxidable.

Vertical soap dispenser 0.5 L.  
Finish: satin.  
Material: stainless steel.

150 x 100 x 115 mm.



**502400-N**

Dosificador de jabón vertical 0.5 L.  
Acabado: negro mate.  
Material: acero inoxidable.

Vertical soap dispenser 0.5 L.  
Finish: matte black.  
Material: stainless steel.

150 x 100 x 115 mm.

**502100**

Dosificador de jabón horizontal 1 L.  
Acabado: cromo brillo.  
Material: acero inoxidable.

Horizontal soap dispenser 1 L.  
Finish: bright chrome.  
Material: stainless steel.

125 x 205 x 110 mm.

**502102**

Dosificador de jabón horizontal 1 L.  
Acabado: satinado.  
Material: acero inoxidable.

Horizontal soap dispenser 1 L.  
Finish: satin.  
Material: stainless steel.

125 x 205 x 110 mm.

**502600-H**

Portarollos industrial.  
Acabado: cromo brillo.  
Material: acero inoxidable.

Industrial toilet roll dispenser.  
Finish: bright chrome.  
Material: stainless steel.

295 x 285 x 120 mm.

**502602-H**

Portarollos industrial.  
Acabado: satinado.  
Material: acero inoxidable.

Industrial toilet roll dispenser.  
Finish: satin.  
Material: stainless steel.

295 x 285 x 120 mm.

**502602-N-H**

Portarollos industrial.  
Acabado: negro mate.  
Material: acero inoxidable.

Industrial toilet roll dispenser.  
Finish: matte black.  
Material: stainless steel.

295 x 285 x 120 mm.

**502500-H**

Dispensador toallitas papel zig-zag.  
Acabado: cromo brillo.  
Material: acero inoxidable.

Zig-zag paper towel dispenser.  
Finish: bright chrome.  
Material: stainless steel.

305 x 265 x 120 mm.

**502502-H**

Dispensador toallitas papel zig-zag.  
Acabado: satinado.  
Material: acero inoxidable.

Zig-zag paper towel dispenser.  
Finish: satin.  
Material: stainless steel.

305 x 265 x 120 mm.

**502501-H**

Dispensador toallitas papel zig-zag.  
Acabado: negro mate.  
Material: acero inoxidable.

Zig-zag paper towel dispenser.  
Finish: matte black.  
Material: stainless steel.

305 x 265 x 120 mm.

**502511**

Dispensador papel mecha.  
Con cerradura superior.  
Con visor del contenido.  
Acabado: cromo brillo.  
Material: acero inoxidable.

Paper towel dispenser.  
Key locking.  
Visual level indicator.  
Finish: bright chrome.  
Material: stainless steel.

370 x 215 x 215 mm.

**502510**

Dispensador papel mecha.  
Con cerradura superior.  
Con visor del contenido.  
Acabado: satinado.  
Material: acero inoxidable.

Paper towel dispenser.  
Key locking.  
Visual level indicator.  
Finish: satin.  
Material: stainless steel.

370 x 215 x 215 mm.

**502512**

Dispensador doble rollo.  
Con cerradura superior.  
Acabado: cromo brillo.  
Material: acero inoxidable.

Double toilet tissue dispenser.  
Key locking.  
Finish: bright chrome.  
Material: stainless steel.

292 x 128 x 124 mm.

**502513**

Dispensador doble rollo.  
Con cerradura superior.  
Acabado: satinado.  
Material: acero inoxidable.

Double toilet tissue dispenser.  
Key locking.  
Finish: satin.  
Material: stainless steel.

292 x 128 x 124 mm.

**502700**

Dosificador de jabón 1 cuerpo.  
Acabado: blanco.  
Material: ABS.

Soap dispenser 1 part.  
Finish: white.  
Material: ABS.

192 x 80 x 92 mm.

**502702**

Dosificador de jabón 1 cuerpo.  
Acabado: gris.  
Material: ABS.

Soap dispenser 1 part.  
Finish: grey.  
Material: ABS.

192 x 80 x 92 mm.

**502800**

Dosificador de jabón 2 cuerpos.  
Acabado: blanco.  
Material: ABS.

Soap dispenser 2 part.  
Finish: white.  
Material: ABS.

192 x 190 x 95 mm.

**502802**

Dosificador de jabón 2 cuerpos.  
Acabado: gris.  
Material: ABS.

Soap dispenser 2 part.  
Finish: grey.  
Material: ABS.

192 x 128 x 124 mm.

**502901**

Dosificador grifo sobrecimera 1 L.  
Diámetro embellecedor: Ø 43 mm.  
Acabado: cromo brillo.  
Material: acero inoxidable y polietileno.

On-table soap dispenser 1 L.  
Trim diameter: Ø 43 mm.  
Finish: bright chrome.  
Material: stainless steel y polyethylene.

270 x 104 x 104 mm.

**502900**

Dosificador grifo sobrecimera 0.4 L.  
Diámetro embellecedor: Ø 43 mm.  
Acabado: cromo brillo.  
Material: acero inoxidable y polietileno.

On-table soap dispenser 0,4 L.  
Trim diameter: Ø 43 mm.  
Finish: bright chrome.  
Material: stainless steel y polyethylene.

270 x 60 x 60 mm.

**508001**

SENSI-E dosificador de jabón o gel hidroalcohólico.  
Capacidad: 600 ml.  
Dosis: 1 ml.  
Voltaje: DC 6V / 4 pilas AA/LR6.  
Rango sensor: 3-5 cm.  
Duración batería: 20.000 ciclos.  
Duración sensor: 300.000 ciclos.  
Acabado: blanco.  
Material: ABS.

SENSI-E soap or hydroalcoholic dispenser.  
Capacity: 600 ml.  
Dose: 1 ml.  
Voltage: DC 6V / 4 AA/LR6 batteries.  
Sensor range: 3-5 cm.  
Battery life: 20.000 cycles.  
Sensor life: 300.000 cycles.  
Finish: white.  
Material: ABS.  
165 x 110 x 95 mm.

**508002**

SENSI dosificador de jabón o gel hidroalcohólico.  
Capacidad: 1100 ml.  
Dosis: 1 ml.  
Voltaje: DC 6V / 4 pilas AA/LR6.  
Rango sensor: 3-5 cm.  
Duración batería: 70.000 ciclos.  
Acabado: blanco.  
Material: ABS.

SENSI soap or hydroalcoholic dispenser.  
Capacity: 1100 ml.  
Dose: 1 ml.  
Voltage: DC 6V / 4 AA/LR6 batteries.  
Sensor range: 3-5 cm.  
Battery life: 70.000 cycles.  
Finish: white.  
Material: ABS.

235 x 140 x 107 mm.

**508005**

SENSINOX dosificador de jabón o gel hidroalcohólico.  
Capacidad: 1200 ml.  
Dosis: 1 ml.  
Voltaje: DC 6V / 4 pilas AA/LR6.  
Rango sensor: 8 cm.  
Duración batería: 70.000 ciclos.  
Acabado: blanco.  
Material: acero inoxidable.

SENSINOX soap or hydroalcoholic dispenser.  
Capacity: 1200 ml.  
Dose: 1 ml.  
Voltage: DC 6V / 4 AA/LR6 batteries.  
Sensor range: 8 cm.  
Battery life: 70.000 cycles.  
Finish: white.  
Material: stainless steel.

215 x 145 x 108 mm.

**508020**

Dispensador de jabón con palanca 1 L.  
Capacidad: 1000 ml.  
Dosis: 1,2-1,5 ml.  
Visor frontal control contenido.  
Acabado: blanco.  
Material: ABS.

Elbow dispenser.  
Capacity: 1000 ml.  
Dose: 1.2-1.5 ml.  
Front display for content control.  
Finish: white.  
Material: ABS.

231 x 111 x 114 mm.

**508006**

Estacion higiénica suelo TOTEM ONE con visor.  
Acabado: negro mate.  
Material: acero.

Floor hygienic station with display.  
Finish: matte black.  
Material: steel.

1540 x 350 x 350 mm.

**508007**

Estacion higiénica suelo TOTEM ONE con visor.  
Acabado: blanco.  
Material: acero.

Floor hygienic station with display.  
Finish: white.  
Material: steel.

1540 x 350 x 350 mm.

**502706**

Dosificador jabón 1 L.  
Acabado: blanco.  
Material: ABS.

Soap dispenser 1 L.  
Finish: white.  
Material: ABS.

210 x 180 x 90 mm.

**502902**

Dispensador de papel.  
Con cerradura superior.  
Con visor del contenido.  
Acabado: blanco.  
Material: ABS.

Toilet roll dispenser.  
Key locking.  
Visual level indicator.  
Finish: white.  
Material: ABS.

326 x 315 x 130 mm.

**502904**

Dispensador de papel mecha.  
Con cerradura superior.  
Con visor del contenido.  
Acabado: blanco.  
Material: ABS.

Roll towel dispenser.  
Key locking.  
Visual level indicator.  
Finish: white.  
Material: ABS.

321 x 207 x 220 mm.

**502707**

Dosificador jabón 1 L.  
Acabado: negro mate.  
Material: ABS.

Soap dispenser 1 L.  
Finish: matte black.  
Material: ABS.

210 x 180 x 90 mm.

**502907**

Dispensador de papel.  
Con cerradura superior.  
Con visor del contenido.  
Acabado: negro mate.  
Material: ABS.

Toilet roll dispenser.  
Key locking.  
Visual level indicator.  
Finish: matte black.  
Material: ABS.

326 x 315 x 130 mm.

**502909**

Dispensador de papel mecha.  
Con cerradura superior.  
Con visor del contenido.  
Acabado: negro mate.  
Material: ABS.

Roll towel dispenser.  
Key locking.  
Visual level indicator.  
Finish: matte black.  
Material: ABS.

321 x 207 x 220 mm.

**502903**

Dispensador de toallitas zig-zag.  
Con cerradura superior.  
Con visor del contenido.  
Acabado: blanco.  
Material: ABS.

Zig-zag paper towel dispenser.  
Key locking.  
Visual level indicator.  
Finish: white.  
Material: ABS.

370 x 285 x 140 mm.

**502906**

Dispensador de toallitas mini.  
Con cerradura superior.  
Con visor del contenido.  
Acabado: blanco.  
Material: ABS.

Mini paper towel dispenser.  
Key locking.  
Visual level indicator.  
Finish: white.  
Material: ABS.

277 x 135 x 135 mm.

**502905**

Dispensador de papel mecha mini.  
Con cerradura superior.  
Con visor del contenido.  
Acabado: blanco.  
Material: ABS.

Mini roll towel dispenser.  
Key locking.  
Visual level indicator.  
Finish: white.  
Material: ABS.

285 x 140 x 150 mm.

**502908**

Dispensador de toallitas zig-zag.  
Con cerradura superior.  
Con visor del contenido.  
Acabado: negro mate.  
Material: ABS.

Zig-zag paper towel dispenser.  
Key locking.  
Visual level indicator.  
Finish: matte black.  
Material: ABS.

370 x 285 x 140 mm.

**502910**

Dispensador de toallitas mini.  
Con cerradura superior.  
Con visor del contenido.  
Acabado: negro mate.  
Material: ABS.

Mini paper towel dispenser.  
Key locking.  
Visual level indicator.  
Finish: matte black.  
Material: ABS.

277 x 135 x 135 mm.

**502911**

Dispensador de papel mecha mini.  
Con cerradura superior.  
Con visor del contenido.  
Acabado: negro mate.  
Material: ABS.

Mini roll towel dispenser.  
Key locking.  
Visual level indicator.  
Finish: matte black.  
Material: ABS.

285 x 140 x 150 mm.

# CAMBIAPAÑALES Y COMPRESEROS

## *Baby changing tables and sanitary pedal*



### 509012

Cambiapañales horizontal.  
Soporta un máximo de 25 kg.  
Acabado: gris.  
Material: polietileno.

Horizontal baby changing table.  
Holds a maximum of 25 kg.  
Finish: grey.  
Material: polyethylene.

900 x 510 x 100 mm.



### 509015

Cambiapañales vertical.  
Soporta un máximo de 20 kg.  
Acabado: blanco.  
Material: polietileno.

Vertical baby changing table.  
Holds a maximum of 20 kg.  
Finish: white.  
Material: polyethylene.

470 x 555 x 860 mm.



### 509040

Cambiapañales horizontal.  
Acabado: satinado.  
Material: HDPE y acero inoxidable.

Horizontal baby changing table.  
Finish: satin.  
Material: HDPE y stainless steel.

920 x 530 x 510 mm.



### 509041

Cambiapañales horizontal.  
Acabado: cromo brillo.  
Material: HDPE y acero inoxidable.

Horizontal baby changing table.  
Finish: bright chrome.  
Material: HDPE y stainless steel.

920 x 530 x 510 mm.



### 509042

Cambiapañales horizontal.  
Acabado: negro mate.  
Material: HDPE y acero inoxidable.

Horizontal baby changing table.  
Finish: matte black.  
Material: HDPE y stainless steel.

920 x 530 x 510 mm.



### 509000

Papelera compresero pedal.  
Acabado: blanco.  
Material: ABS.

Sanitary pedal bin.  
Finish: white.  
Material: ABS.

570 x 180 x 360 mm.



### 509001

Papelera compresero.  
Acabado: satinado.  
Material: acero inoxidable.

Sanitary bin.  
Finish: satin.  
Material: stainless steel.

650 x 200 x 320 mm.

# PAPELERAS *Trash*



**500805**  
Cubo pedal hybrid 20 L.  
Acabado: satinado.  
Material: resina y metal.

Hybrid pedal bin 20 L.  
Finish: satin.  
Material: resin y metal.

430 x 360 x 360 mm.



**500810**  
Cubo pedal hybrid 30 L.  
Acabado: carbono.  
Material: resina y metal.

Hybrid pedal bin 30 L.  
Finish: carbon.  
Material: resin y metal.

590 x 360 x 300 mm.



**500812**  
Cubo pedal hybrid 40 L.  
Acabado: carbono.  
Material: resina y metal.

Hybrid pedal bin 40 L.  
Finish: carbon.  
Material: resin y metal.

676 x 295 x 353 mm.



**500811**  
Cubopedal hybrid 50 L.  
Acabado: carbono.  
Material: resina y metal.

Hybrid pedal bin 50 L.  
Finish: carbon.  
Material: resin y metal.

670 x 440 x 290 mm.



**501700**  
Papelerera rectangular mural 25 L.  
Acabado: cromo brillo.  
Material: acero inoxidable.

Wall mounted waste bin rectangular 25 L.  
Finish: bright chrome.  
Material: stainless steel.

450 x 355 x 155 mm.



**501701**  
Papelerera rectangular mural 25 L.  
Acabado: satinado.  
Material: acero inoxidable.

Wall mounted waste bin rectangular 25 L.  
Finish: satin.  
Material: stainless steel.

450 x 355 x 155 mm.



**501700-N**  
Papelerera rectangular mural 25 L.  
Acabado: negro mate.  
Material: acero inoxidable.

Wall mounted waste bin rectangular 25 L.  
Finish: matte black.  
Material: stainless steel.

450 x 355 x 155 mm.



**501721**  
Papelerera cuadrada con cubeta extraíble 14.5 L.  
Acabado: cromo brillo.  
Material: acero inoxidable.

Waste bin with removable inner bucket 14.5 L.  
Finish: bright chrome.  
Material: stainless steel.

320 x 220 x 220 mm.



**501726**  
Papelerera cabezal basculante 100 L.  
Acabado: satinado.  
Material: acero inoxidable.

Swivel-head wastepaper bin 100 L.  
Finish: satin.  
Material: stainless steel.

970 x 360 x 360 mm.



**501602**  
Papelerera cabezal basculante 40 L.  
Acabado: satinado.  
Material: acero inoxidable.

Swivel-head wastepaper bin 40 L.  
Finish: satin.  
Material: stainless steel.

680 x 320 x 260 mm.



**501601-N**  
Papelerera cabezal basculante 40 L.  
Acabado: negro mate.  
Material: acero inoxidable.

Swivel-head wastepaper bin 40 L.  
Finish: matte black.  
Material: stainless steel.

680 x 320 x 260 mm.



**501601**  
Papelerera cabezal basculante 40 L.  
Acabado: blanco.  
Material: acero inoxidable.

Swivel-head wastepaper bin 40 L.  
Finish: white.  
Material: stainless steel.

680 x 320 x 260 mm.



**501725**  
Papelerera pasillo 40 L.  
Acabado: satinado.  
Material: acero inoxidable.

Aisle trash bin 40 L.  
Finish: satin.  
Material: stainless steel.

700 x 240 x 240 mm.



**501730**  
Papelerera cuadrada 10L.  
Acabado: inox brillo.  
Material: acero inoxidable.

Wall mounted square waste bin 10 L.  
Finish: bright inox.  
Material: stainless steel.

300 x 180 x 180 mm.



**501731**  
Papelerera cuadrada 10L.  
Acabado: inox satinado.  
Material: acero inoxidable.

Wall mounted square waste bin 10 L.  
Finish: satin inox.  
Material: stainless steel.

300 x 180 x 180 mm.



**501731-N**  
Papelerera cuadrada 10L.  
Acabado: negro mate.  
Material: acero inoxidable.

Wall mounted square waste bin 10 L.  
Finish: matte black.  
Material: stainless steel.

300 x 180 x 180 mm.



**501708**  
Papelerera cilíndrica perforada 60 L.  
Acabado: cromo brillo.  
Material: acero inoxidable.

Outdoor trash bin 60L.  
Finish: bright chrome.  
Material: stainless steel.

850 x 460 x 370 mm.



**501709**  
Papelerera cilíndrica perforada 60 L.  
Acabado: blanco.  
Material: acero inoxidable.

Outdoor trash bin 60L.  
Finish: white.  
Material: stainless steel.

850 x 460 x 370 mm.



**501808**

Papelera reciclaje tres residuos con aros sujeta-bolsas.  
Acabado: negro.  
Material: chapa electrocincada.

Three-waste recycling bin with bag-holding rings.  
Finish: black.  
Material: electrogalvanised sheet metal.

840 x 500 x 300 mm.



**501813**

Papelera clasificacion tres residuos con aros sujeta-bolsas.  
Acabado: satinado.  
Material: acero inoxidable y chapa electrocincada.

Three waste sorting bin with bag-holder rings.  
Finish: satin.  
Material: stainless steel y electrogalvanised sheet metal.

900 x 490 x 575 mm.



**501707**

Papelra mural 10 L.  
Acabado: satinado.  
Material: acero inoxidable.

Wall mounted waste bin 10L.  
Finish: satin.  
Material: stainless steel.

350 x 257 x 125 mm.



**501728**

Cenicero arenero.  
Acabado: satinado.  
Material: acero inoxidable.

Sandbox ashtray.  
Finish: satin.  
Material: stainless steel.

810 x 440 x 440 mm.



**501734**

Papelera cenicero mural cubo abatible.  
Acabado: negro .  
Material: chapa electrocincada.

Ashtray wall hinged bucket.  
Finish: black .  
Material: electrogalvanised sheet metal.

500 x 320 x 160 mm.



**501520**

Papelera reciclaje exterior doble cubo.  
Acabado: múltiple.  
Material: chapa de acero y chapa electrocincada.

Outdoor recycling bin double bin.  
Finish: multiple.  
Material: steel sheet metal y electrogalvanised sheet metal.

880 x 520 x 250 mm.



**501521**

Papelera reciclaje exterior triple cubo.  
Acabado: múltiple.  
Material: chapa de acero y chapa electrocincada.

Outdoor recycling bin triple bin.  
Finish: multiple.  
Material: steel sheet metal y electrogalvanised sheet metal.

880 x 780 x 250 mm.



# CARROS DE LIMPIEZA

## CLEANING TROLLEYS



### 509020

Carro de limpieza en L.  
Acabado: gris.  
Material: HDPE.

Cleaning trolley.  
Finish: grey.  
Material: HDPE.

980 x 510 x 1135 mm.



### 509028

Carro de limpieza en L.  
Acabado: negro.  
Material: HDPE.

Cleaning trolley.  
Finish: black.  
Material: HDPE.

1000 x 545 x 1300 mm.



### 509024

Carro lavandería recto.  
Acabado: negro y caqui.  
Material: acero y lona sintética.

Laundry trolley.  
Finish: black y khaki.  
Material: steel and synthetic fabric.

900 x 940 x 560 mm.



### 509027

Carro lavandería en X.  
Acabado: cromo brillo y caqui.  
Material: acero y lona sintética.

Laundry trolley.  
Finish: bight chrome and khaki.  
Material: steel and synthetic fabric.

985 x 625 x 625 mm.

La serie de Ayudas Técnicas ofrece una gama de productos diseñados para garantizar la seguridad y comodidad de las personas con movilidad reducida.

Entre ellos se encuentran **barras de apoyo, asientos de ducha, espejos abatibles y artículos sanitarios para geriatría**, todos pensados para facilitar el acceso y la autonomía en baños y espacios adaptados.

Fabricados en **acero inoxidable y acero recubierto de PVC**, estos productos cumplen con la normativa europea, asegurando resistencia, durabilidad y un diseño funcional que se integra en cualquier entorno.

*The Technical Aids series offers a range of products designed to ensure the safety and comfort of people with reduced mobility.*

*These include **grab bars, shower seats, folding mirrors and sanitary ware for geriatrics**, all designed to facilitate access and autonomy in adapted bathrooms and spaces.*

*Manufactured in **stainless steel and PVC-coated steel**, these products comply with European standards, ensuring strength, durability and a functional design that integrates into any environment* Translated with DeepL.com (free version)

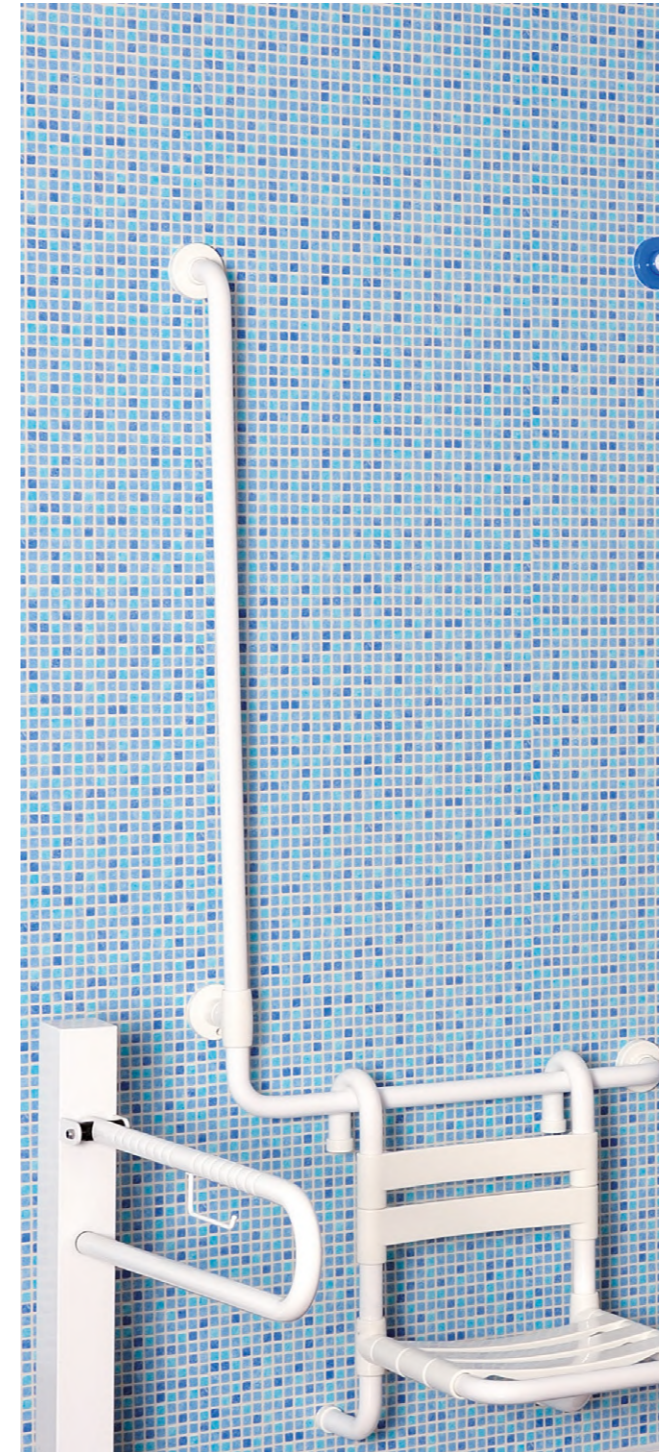

## Ayudas técnicas

*Technical aids*

ACERO INOXIDABLE 324  
TAINLESS STEEL

ACERO RECUBIERTO PVC 332  
PVC-COATED STEEL

ESPEJOS 336  
MIRRORS

SANITARIOS GERIATRÍA 338  
GERIATRIC SANITARY WARE

# ACERO INOXIDABLE

## Stainless steel

**600100**

Asidero barra 30 cm.  
Acabado: cromo brillo.  
Material: acero inoxidable.  
Grab rail 30 cm.  
Finish: bright chrome.  
Material: stainless steel.  
61 x 331 x 79 mm.

**600102**  
Satinado / Satin

**600108**  
Blanco / White

**600200**

Asidero barra 40 cm.  
Acabado: cromo brillo.  
Material: acero inoxidable.  
Grab rail 40 cm.  
Finish: bright chrome.  
Material: stainless steel.  
62 x 431 x 79 mm.

**600202**  
Satinado / Satin

**600208**  
Blanco / White

**600300**

Asidero barra 50 cm.  
Acabado: cromo brillo.  
Material: acero inoxidable.  
Grab rail 50 cm.  
Finish: bright chrome.  
Material: stainless steel.  
63 x 531 x 79 mm.

**600302**  
Satinado / Satin

**600308**  
Blanco / White

**600400**

Asidero barra 60 cm.  
Acabado: cromo brillo.  
Material: acero inoxidable.  
Grab rail 60 cm.  
Finish: bright chrome.  
Material: stainless steel.  
64 x 631 x 79 mm.

**600402**  
Satinado / Satin

**600408**  
Blanco / White

**600500**

Asidero barra 80 cm.  
Acabado: cromo brillo.  
Material: acero inoxidable.  
Grab rail 80 cm.  
Finish: bright chrome.  
Material: stainless steel.  
65 x 831 x 79 mm.

**600502**  
Satinado / Satin

**600508**  
Blanco / White

**600900**

Asidero rincón 75 cm.  
Acabado: cromo brillo.  
Material: acero inoxidable.  
Corner grab rail 75 cm.  
Finish: bright chrome.  
Material: stainless steel.  
61 x 805 x 805 mm.

**600902**  
Satinado / Satin

**600908**  
Blanco / White

**600700**

Asidero 90°.  
Acabado: cromo brillo.  
Material: acero inoxidable.  
90° angled grab rail.  
Finish: bright chrome.  
Material: stainless steel.  
546 x 546 x 79 mm.

**600702**  
Satinado / Satin

**600708**  
Blanco / White

**601000**

Asidero rincón 120 cm.  
Acabado: cromo brillo.  
Material: acero inoxidable.  
Corner grab rail 120 cm.  
Finish: bright chrome.  
Material: stainless steel.  
61 x 1255 x 805 mm.

**601002**  
Satinado / Satin

**601008**  
Blanco / White

**600600**

Asidero 135°.  
Acabado: cromo brillo.  
Material: acero inoxidable.  
135° angled grab rail.  
Finish: bright chrome.  
Material: stainless steel.  
267 x 548 x 79 mm.

**600602**  
Satinado / Satin

**600608**  
Blanco / White

**600800**

Asidero 30°.  
Acabado: cromo brillo.  
Material: acero inoxidable.  
30° angled grab rail.  
Finish: bright chrome.  
Material: stainless steel.  
304 x 966 x 79 mm.

**600802**  
Satinado / Satin

**600808**  
Blanco / White

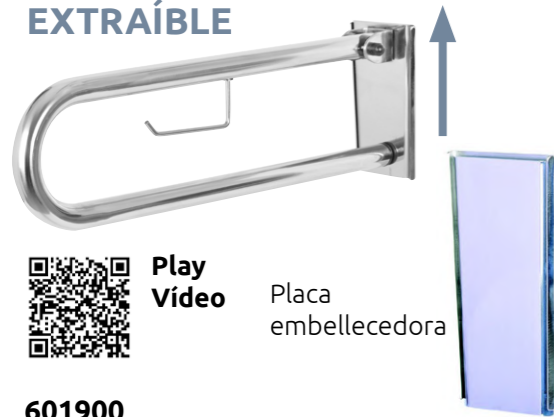
**SISTEMA EXTRAÍBLE**

Play Video

Placa embellecedora

**601900**

Asidero abatible y extraíble con portarrollos.  
Acabado: cromo brillo.  
Material: acero inoxidable.  
Removable folding support rail with paper holder.  
Finish: bright chrome.  
Material: stainless steel.  
200 x 708 x 104 mm.

**601902**

Satinado / Satin

**601908**

Blanco / White

**601100**

Asidero abatible con portarrollos.  
Acabado: cromo brillo.  
Material: acero inoxidable.  
Folding support rail with paper holder.  
Finish: bright chrome.  
Material: stainless steel.  
200 x 700 x 79 mm.  
200 x 800 x 79 mm. (601700)

**601102 (700 mm)**Satinado / Satin  
601702 (800 mm)**601108 (700 mm)**Blanco / White  
601708 (800 mm)**601300**

Asidero fijo 3 apoyos  
Acabado: cromo brillo.  
Material: acero inoxidable.  
3 anchoring points grab rail.  
Finish: bright chrome.  
Material: stainless steel.  
204 x 699 x 204 mm.

**601302**

Satinado / Satin

**601308**

Blanco / White

**601200**

Asiento abatible al suelo con lamas de PVC.  
Acabado: cromo brillo.  
Material: acero inoxidable y PVC.  
Folding seat with PVC slats.  
Finish: bright chrome.  
Material: stainless steel and PVC.  
480 x 422 x 427 mm.

**601202**

Satinado / Satin

**601208**

Blanco / White

**SISTEMA EXTRAÍBLE****608210**

Asiento abatible y extraíble con lamas de PVC.  
Acabado: cromo brillo.  
Material: acero inoxidable y PVC.  
Removable folding seat with PVC slats.  
Finish: bright chrome.  
Material: stainless steel and PVC.  
385 x 420 x 505 mm.

**608212**

Satinado / Satin

**608218**

Blanco / White

**601600**

Asidero abatible pedestal.  
Acabado: cromo brillo.  
Material: acero inoxidable.  
Floor folding grab rail.  
Finish: bright chrome.  
Material: stainless steel.  
850 x 807 x 130 mm.

**601602**

Satinado / Satin

**601608**

Blanco / White

**601400**

Asidero abatible pata.  
Acabado: cromo brillo.  
Material: acero inoxidable.  
Folding grab rail with leg.  
Finish: bright chrome.  
Material: stainless steel.  
781 x 764 x 108 mm.

**601402**

Satinado / Satin

**601408**

Blanco / White

**604700**

Asidero abatible con pata articulada 80 cm.  
Acabado: cromo brillo.  
Material: acero inoxidable.  
Folding grab rail with articulated leg 80 cm.  
Finish: bright chrome.  
Material: stainless steel.  
780 x 108 x 796 mm

**604702**

Satinado / Satin

**601500**

Asidero apoyo suelo 90°  
Acabado: cromo brillo.  
Material: acero inoxidable.  
90° floor grab rail.  
Finish: bright chrome.  
Material: stainless steel.  
774 x 800 x 204 mm.

**601502**

Satinado / Satin

**601508**

Blanco / White

**608404**

Asiento abatible con lamas de PVC.  
Acabado: gris.  
Material: acero inoxidable y PVC.  
Folding seat with PVC slats.  
Finish: grey.  
Material: stainless steel and PVC.  
115 x 470 x 410 mm.

**608407**

Asiento abatible con placa corta y lamas de PVC.  
Acabado: blanco.  
Material: acero inoxidable y PVC.  
Folding seat with short plate and PVC slats.  
Finish: white.  
Material: stainless steel and PVC.  
140 x 490 x 410 mm.

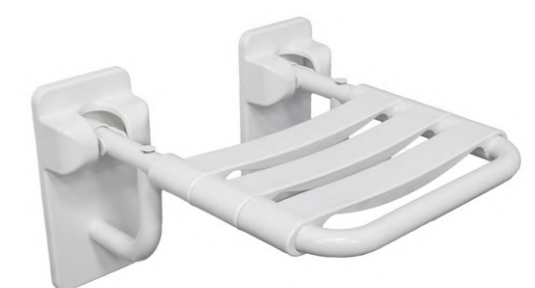
**608406**

Asiento abatible con placa larga, patas y lamas de PVC.  
Acabado: blanco.  
Material: acero inoxidable y PVC.  
Folding seat with long plate, legs and PVC slats.  
Finish: white.  
Material: stainless steel and PVC.  
300 x 490 x 470 mm.

# ACERO INOXIDABLE

## *Stainless steel*

**600100-N**

Asidero barra 30 cm.  
Acabado: negro mate.  
Material: acero inoxidable.  
Grab rail 30 cm.  
Finish: matte black.  
Material: stainless steel.  
61 x 331 x 79 mm.

**600200-N**

Asidero barra 40 cm.  
Acabado: negro mate.  
Material: acero inoxidable.  
Grab rail 40 cm.  
Finish: matte black.  
Material: stainless steel.  
62 x 431 x 79 mm.

**600300-N**

Asidero barra 50 cm.  
Acabado: negro mate.  
Material: acero inoxidable.  
Grab rail 50 cm.  
Finish: matte black.  
Material: stainless steel.  
63 x 531 x 79 mm.

**600400-N**

Asidero barra 60 cm.  
Acabado: negro mate.  
Material: acero inoxidable.  
Grab rail 60 cm.  
Finish: matte black.  
Material: stainless steel.  
64 x 631 x 79 mm.

**600500-N**

Asidero barra 80 cm.  
Acabado: negro mate.  
Material: acero inoxidable.  
Grab rail 80 cm.  
Finish: matte black.  
Material: stainless steel.  
65 x 831 x 79 mm.

**600900-N**

Asidero rincón 75 cm.  
Acabado: negro mate.  
Material: acero inoxidable.  
Corner grab rail 75 cm.  
Finish: matte black.  
Material: stainless steel.  
61 x 805 x 805 mm.

**600600-N**

Asidero 135°.  
Acabado: negro mate.  
Material: acero inoxidable.  
135° angled grab rail.  
Finish: matte black.  
Material: stainless steel.  
267 x 548 x 79 mm.

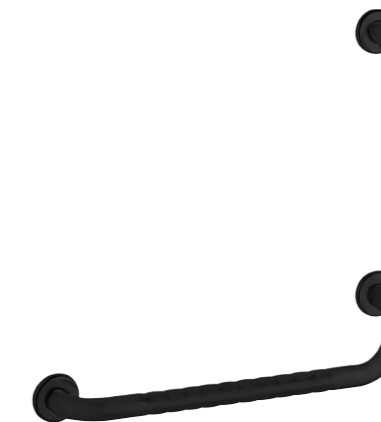
**600700-N**

Asidero 90°.  
Acabado: negro mate.  
Material: acero inoxidable.  
90° angled grab rail.  
Finish: matte black.  
Material: stainless steel.  
546 x 546 x 79 mm.

**600800-N**

Asidero 30°.  
Acabado: negro mate.  
Material: acero inoxidable.  
30° angled grab rail.  
Finish: matte black.  
Material: stainless steel.  
304 x 966 x 79 mm.



**SISTEMA EXTRAÍBLE**



Play Video

Placa embellecedora

**601900-N**

Asidero abatible y extraíble con portarrollos.  
Acabado: negro mate.  
Material: acero inoxidable.  
Removable folding support rail with paper holder.  
Finish: matte black.  
Material: stainless steel.  
200 x 708 x 104 mm.



**601100-N**

Asidero abatible con portarrollos.  
Acabado: negro mate.  
Material: acero inoxidable.  
Folding support rail with paper holder.  
Finish: matte black.  
Material: stainless steel.  
200 x 700 x 79 mm.



**601200-N**

Asiento abatible al suelo con lamas de PVC.  
Acabado: negro mate.  
Material: acero inoxidable y PVC.  
Folding seat with PVC slats.  
Finish: matte black.  
Material: stainless steel and PVC.  
480 x 422 x 427 mm.



**608408**

Asiento abatible con placa corta y lamas de PVC.  
Acabado: negro mate.  
Material: acero inoxidable y PVC.  
Folding seat with short plate and PVC slats.  
Finish: matte black.  
Material: stainless steel and PVC.  
140 x 490 x 410 mm.



**SISTEMA EXTRAÍBLE**



**608210-N**

Asiento abatible y extraíble con lamas de PVC.  
Acabado: negro mate.  
Material: acero inoxidable y PVC.  
Removable folding seat with PVC slats.  
Finish: matte black.  
Material: stainless steel and PVC.  
385 x 420 x 505 mm.



**608405**

Asiento abatible con placa larga, patas y lamas de PVC.  
Acabado: negro mate.  
Material: acero inoxidable y PVC.  
Folding seat with short plate, legs and PVC slats.  
Finish: matte black.  
Material: stainless steel and PVC.  
300 x 490 x 470 mm.

# ACERO RECUBIERTO PVC

## PVC coated steel

**605709**

Asidero barra 30 cm.  
Acabado: blanco.  
80 x 380 x 82 mm.

Grab rail 30 cm.  
Finish: white.

**605809**

Asidero barra 40 cm.  
Acabado: blanco.  
80 x 480 x 82 mm.

Grab rail 40 cm.  
Finish: white.

**605909**

Asidero barra 50 cm.  
Acabado: blanco.  
80 x 580 x 82 mm.

Grab rail 50 cm.  
Finish: white.

**606009**

Asidero barra 60 cm.  
Acabado: blanco.  
80 x 680 x 82 mm.

Grab rail 60 cm.  
Finish: white.

**606109**

Asidero barra 70 cm.  
Acabado: blanco.  
80 x 780 x 82 mm.

Grab rail 70 cm.  
Finish: white.

**606209**

Asidero barra 80 cm.  
Acabado: blanco.  
80 x 880 x 82 mm.

Grab rail 80 cm.  
Finish: white.

**606309**

Asidero barra 90 cm.  
Acabado: blanco.  
80 x 980 x 82 mm.

Grab rail 90 cm.  
Finish: white.

**607109**

Asidero rincón 70 cm.  
Acabado: blanco.  
Corner grab rail 70 cm.  
Finish: white.  
81 x 814 x 814 mm.

**607209**

Asidero rincón 120 cm.  
Acabado: blanco.  
Corner grab rail 120 cm.  
Finish: white.  
81 x 1314 x 814 mm.

**606409**

Asidero ángulo 135°.  
Acabado: blanco.  
135° angled grab rail.  
Finish: white.  
303 x 618 x 82 mm.

**606909**

Asidero 90° con soporte ducha izquierda.  
Acabado: blanco.  
90° grab rail left hand shower support.  
Finish: white.  
1280 x 804 x 804 mm.

**606709**

Asidero 90° con soporte ducha izquierda.  
Acabado: blanco.  
90° grab rail left hand shower support.  
Finish: white.  
1280 x 780 x 82 mm.

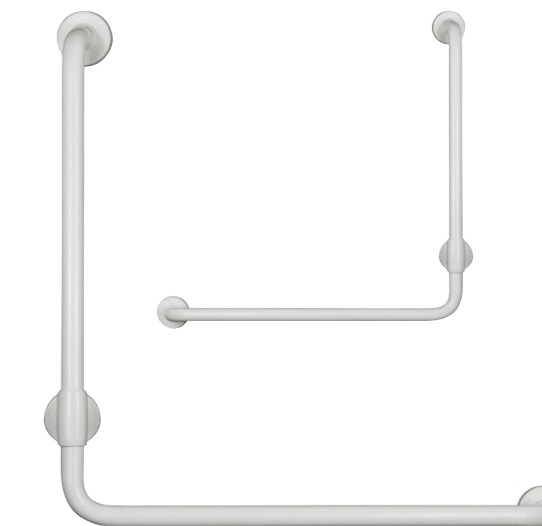
**606509**

Asidero 90° izquierda.  
Acabado: blanco.  
90° left grab rail.  
Finish: white.  
780 x 780 x 82 mm.

**607009**  
Derecha/Right

**606809**  
Derecha/Right

**606609**  
Derecha/Right

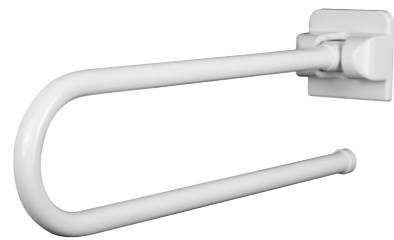
**603009**

Asidero abatible 60 cm.  
Acabado: blanco.  
Folding grab rail 60 cm.  
Finish: white.  
240 x 600 x 145 mm.

**603109**  
70 cm.

**603209**  
80 cm.

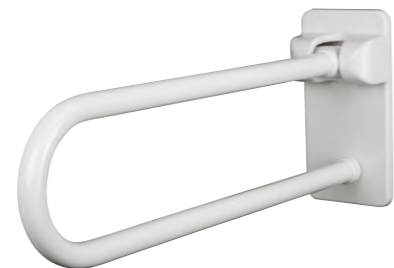
**603609**

Asidero abatible con placa trasera 60 cm.  
Acabado: blanco.  
Folding grab rail with back plate 60 cm.  
Finish: white.  
297 x 600 x 145 mm.

**603709**  
70 cm.

**603709**  
80 cm.

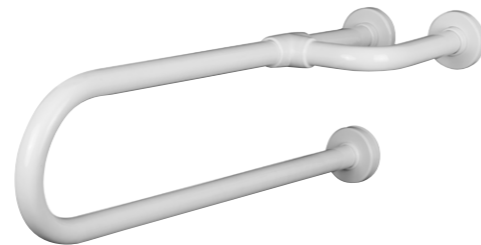
**604809**

Asidero fijo 3 apoyos reversible 60 cm.  
Acabado: blanco.  
Reversible 3-support fixed grab rail 60 cm.  
Finish: white.  
225 x 598 x 225 mm.

**604909**  
70 cm.

**605009**  
80 cm.

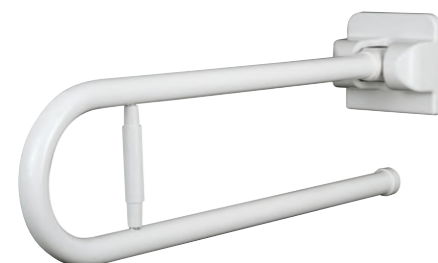
**603309**

Asidero abatible con portarrollos 60 cm.  
Acabado: blanco.  
Folding grab rail with paper holder 60 cm.  
Finish: white.  
240 x 600 x 145 mm.

**603409**  
70 cm.

**603509**  
80 cm.

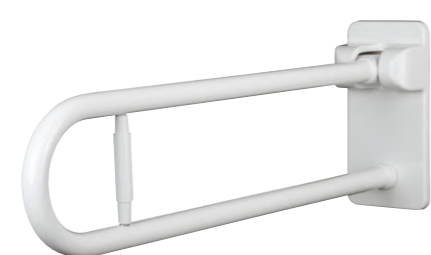
**603909**

Asidero abatible con placa trasera y portarrollos 60 cm.  
Acabado: blanco.  
Folding grab rail with back plate and paper holder 60 cm.  
Finish: white.  
297 x 600 x 145 mm.

**604009**  
70 cm.

**604109**  
80 cm.

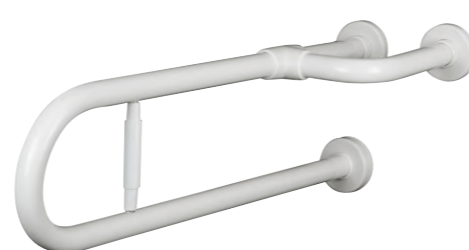
**605109**

Asidero fijo 3 apoyos reversible con portarrollos 60 cm.  
Acabado: blanco.  
Reversible 3-support fixed grab rail and paper holder 60 cm.  
Finish: white.  
225 x 598 x 225 mm.

**605209**  
70 cm.

**605309**  
80 cm.

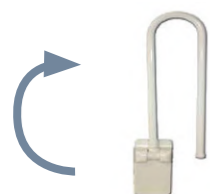

Disponibles con giro de 180° a pared bajo consulta previa.  
Available for rotation up to 180° on request.

**604209**

Asidero abatible con pedestal 60 cm.  
Acabado: blanco.  
Folding grab rail with pedestal 60 cm.  
Finish: white.  
850 x 600 x 80 mm.

**604309**  
70 cm.

**604409**  
80 cm.

**604209-P**

Con portarrollos 60 cm.  
With paper holder 60 cm.

**604309-P**

Con portarrollos 70 cm.  
With paper holder 70 cm.

**604409-P**

Con portarrollos 80 cm.  
With paper holder 80 cm.

**604509**

Asidero abatible con pata articulada 60 cm.  
Acabado: blanco.  
Folding grab rail with articulated leg 60 cm.  
Finish: white.  
721 x 594 x 145 mm.

**604609**  
70 cm.

**604709**  
80 cm.

**604509-P**

Con portarrollos 60 cm.  
With paper holder 60 cm.

**604609-P**

Con portarrollos 70 cm.  
With paper holder 70 cm.

**604709-P**

Con portarrollos 80 cm.  
With paper holder 80 cm.

**605409**

Asidero pared suelo 3 anclajes.  
Acabado: blanco.  
Floor wall handle 3 anchorages.  
Finish: white.  
760 x 640 x 225 mm.

**605509**  
70 cm.

**605609**  
80 cm.

# ESPEJOS ABATIBLES

## *Folding mirrors*

**608201**

Espejo abatible con marco inox.  
Acabado: brillo.  
Material: acero inoxidable.  
Folding mirror with stainless steel frame.  
Finish: bright.  
Material: stainless steel.  
705 x 505 x 86 mm

**608200**

Espejo abatible con marco blanco.  
Acabado: blanco.  
Material: acero inoxidable.  
Folding mirror with white frame.  
Finish: white.  
Material: stainless steel.  
700 x 560 x 90 mm.

**608202**

Espejo abatible sin marco.  
Acabado: brillo.  
Material: acero inoxidable.  
Folding mirror without frame.  
Finish: bright.  
Material: stainless steel.  
700 x 560 x 90 mm.

# SANITARIO GERIATRÍA

## *Geriatric sanitary ware*

**720001**

Inodoro a pared con apertura frontal.

*Ergonomic WC with front opening-wall.*

510 x 385 x 580 mm

**720002**

Salida a suelo.  
*Opening-floor.*

**720500**

Inodoro bidé salida a suelo.  
*Ergonomic WC bidet with frontal opening-floor.*

**720900**

Inodoro monoblock a pared.

*WC monoblock-wall*

870 x 380 x 800 mm.

**720901**

Cisterna.  
*Cistern.*

**720902**

Tapa.  
*Seat cover.*

**721000**

Inodoro monoblock con apertura frontal al suelo – salida suelo.

*Ergonomic WC monoblock - floor.*

840 x 390 x 750 mm.

**721001**

Salida a pared.  
*Opening-floor.*

**721002**

Cisterna.  
*Cistern.*

**720800**

Inodoro suspendido con apertura fontal.

*Ergonomic suspended WC frontal opening*

500 x 390 x 560 mm.

**720801**

Tapa.  
*Seat cover.*

**720300**

Cisterna en ABS con pulsador a pared.  
 ABS toilet cistern with wall mounted push button.  
 410 x 440 x 130 mm.

**720301**

Cisterna ABS completa.  
 ABS toilet cistern.  
 1200-500 x 380 x 128 mm.

**705800**

Grifo con palanca clínica.  
 Clinical lever tap.  
 210 x 50 x 115 mm.

**720100**

Lavabo ergonómico.  
 Ergonomic wash basin.  
 235 x 650 x 570 mm.

**720200**

Soporte lavabo hidráulico.  
 Pneumatic support for disabled.  
 155 x 587 x 570 mm.

**720004**

Tapa alzador 10 cm con tratamiento antibacteriano.  
 Rubber ring 10 cm raised with antibacterial treatment.  
 10 x 380 x 440 mm.

**720003**

Tapa inodoro.  
 WC seat cover.  
 58 x 380 x 490 mm.

**720600**

Sifón flexible.  
 Flexible siphon.

**720700**

Soportes fijación sanitario suspendido.  
 Suspended sanitary fixing brackets.

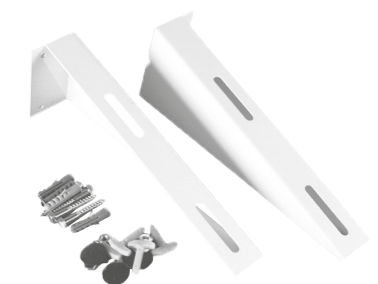
**720102**

Conjunto soportes fijación lavabo ergonómico.  
 Ergonomic washbasin fixing bracket set.





**ASIDERO PARED/SUELO 90°**  
*90° FLOOR TO WALL GRAB RAIL*

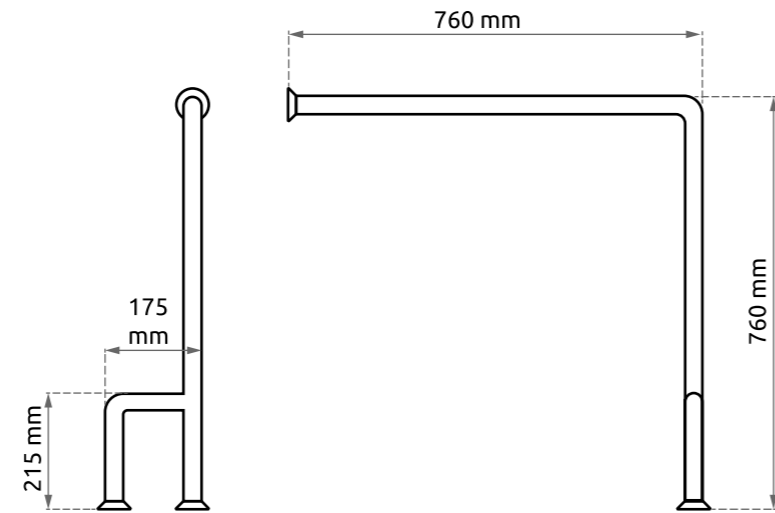

**ASIDERO FIJO 180°**  
*180° WALL MOUNTED GRAB RAIL*

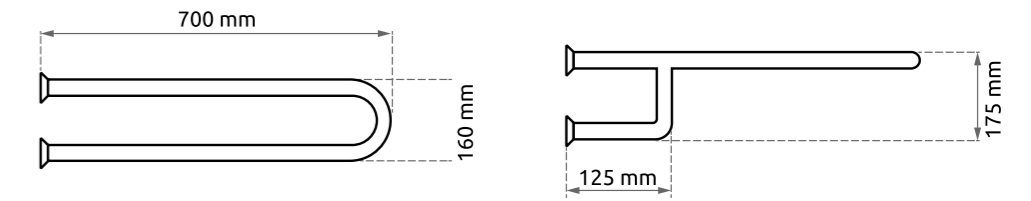

**ASIDERO ABATIBLE 180° CON PEDESTAL**  
*180° FLOOR MOUNTED FOLDING GRAB RAIL*

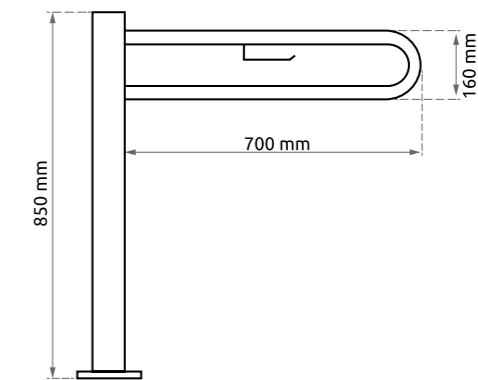

**ASIDERO 135°**  
*135° GRAB RAIL*

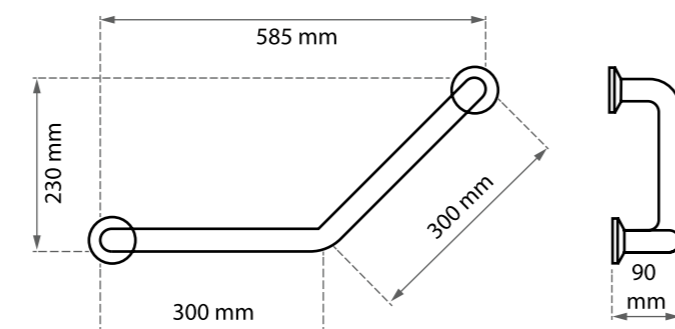

**ASIDERO RECTO**  
*90° FLOOR O WALL GRAB RAIL*

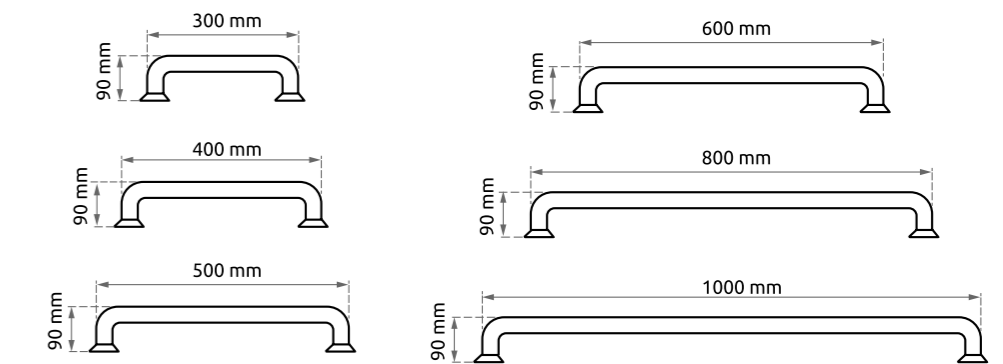



**ASIDERO 90°**  
*90° GRAB RAIL*

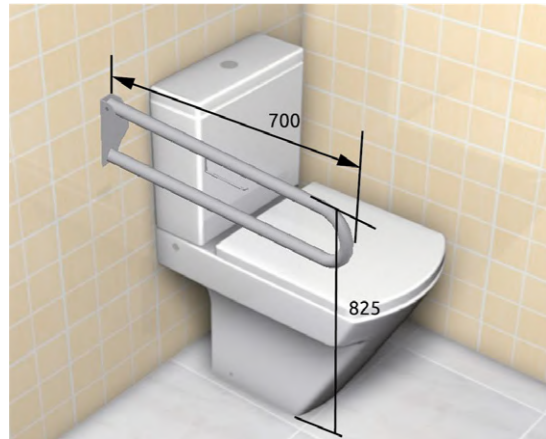
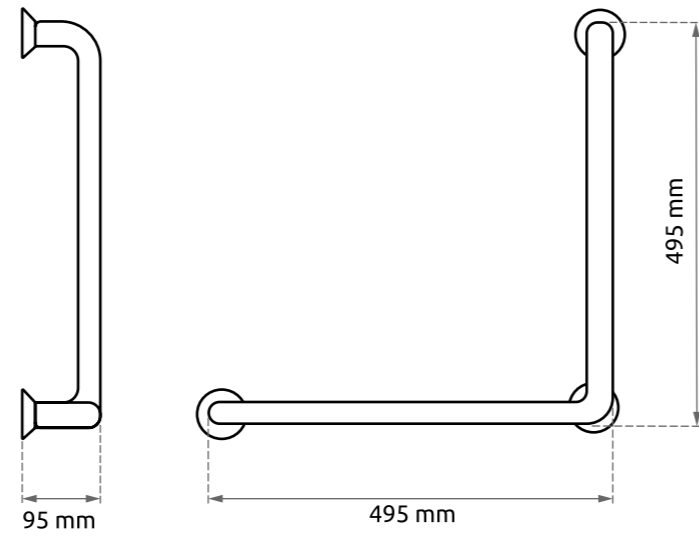

**ASIDERO ABATIBLE 180°**  
*180° FOLDING GRAB RAIL*

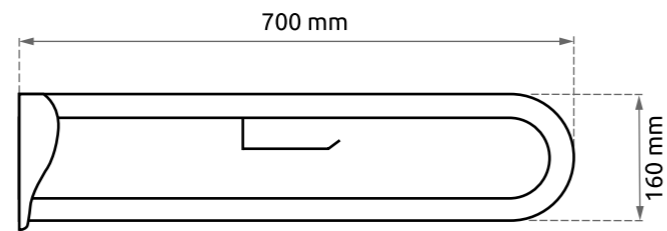

**ASIDERO ABATIBLE 180° CON PATA**  
*180° FOLDING GRAB RAIL WITH LEG*

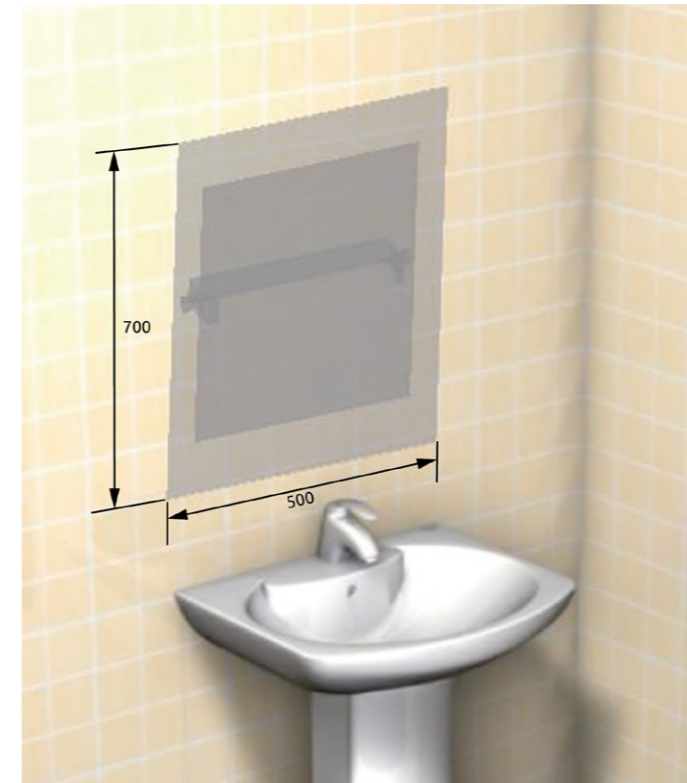
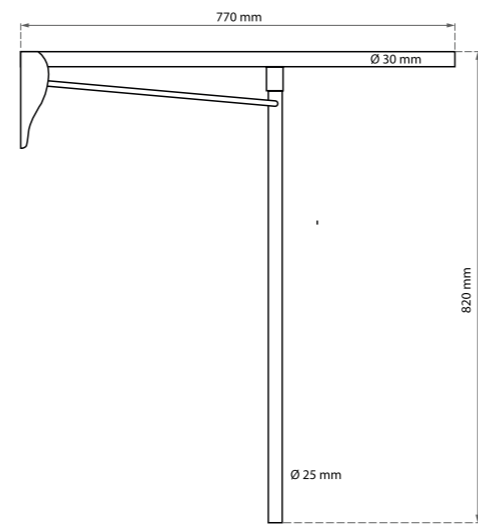

**ESPEJO RECTANGULAR**  
*FOLDING BATHROOM MIRROR*

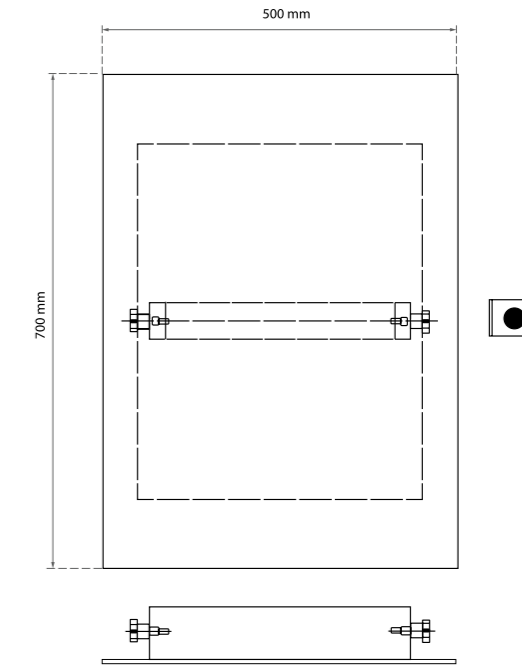

**ASIENTO ABATIBLE CON APOYO AL SUELO**  
*FOLDING SHOWER SEAT*

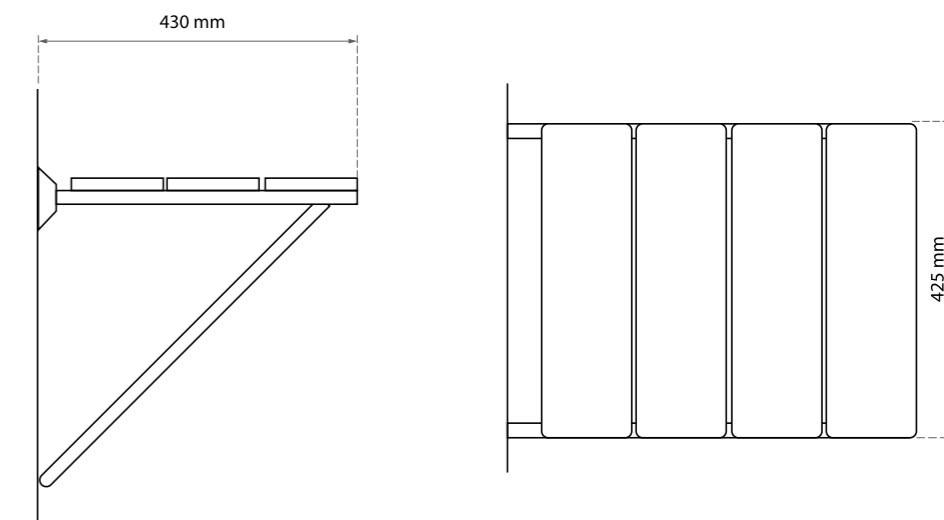

**BARRAS DE APOYO EN INODOROS**  
**GRAB RAILS IN WC**  
 Transferencia frontal / oblicua y lateral  
*Front / oblique and lateral transfer*

Por un lado / *On one side*

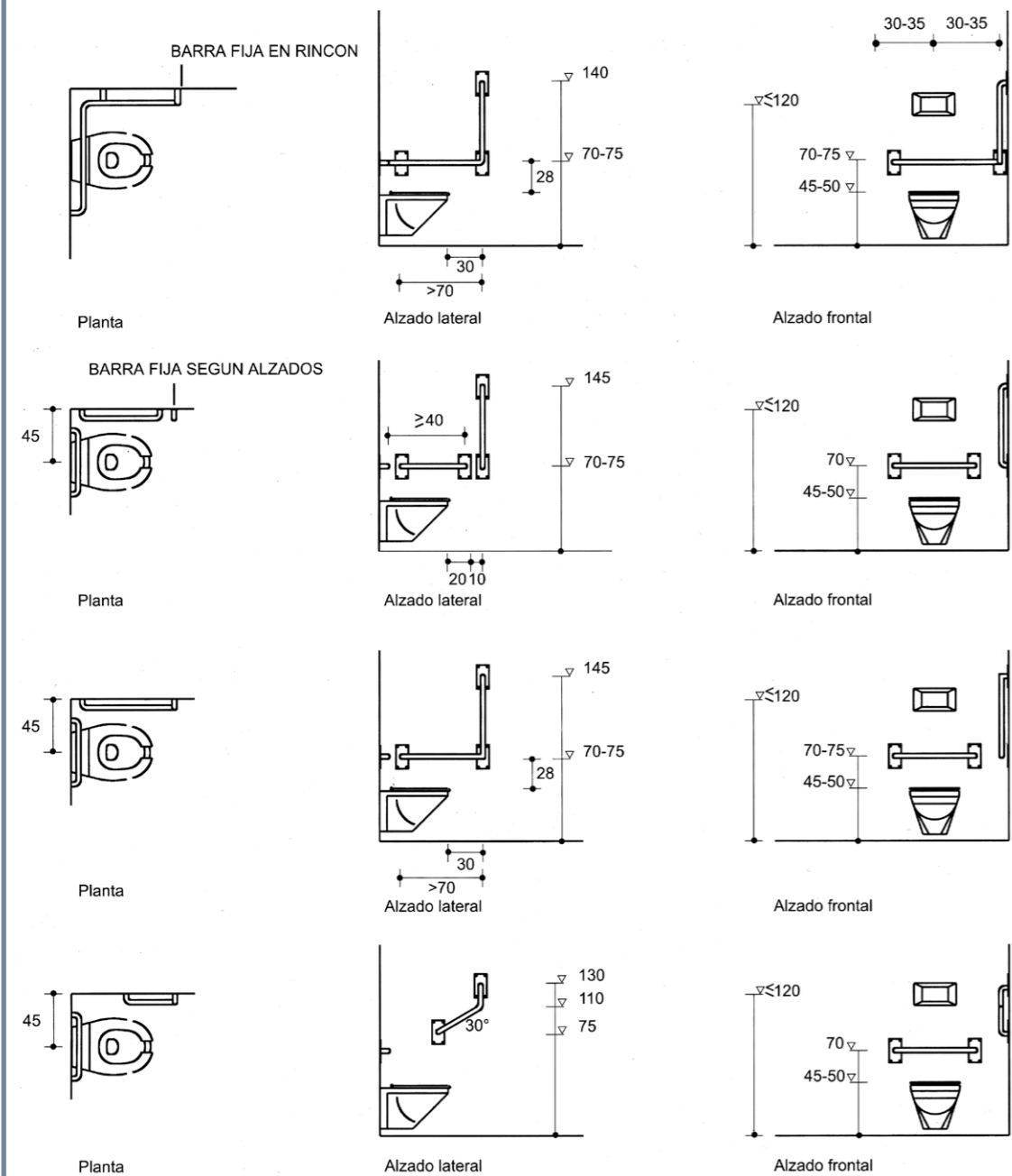

Por ambos lados / *Both sides*

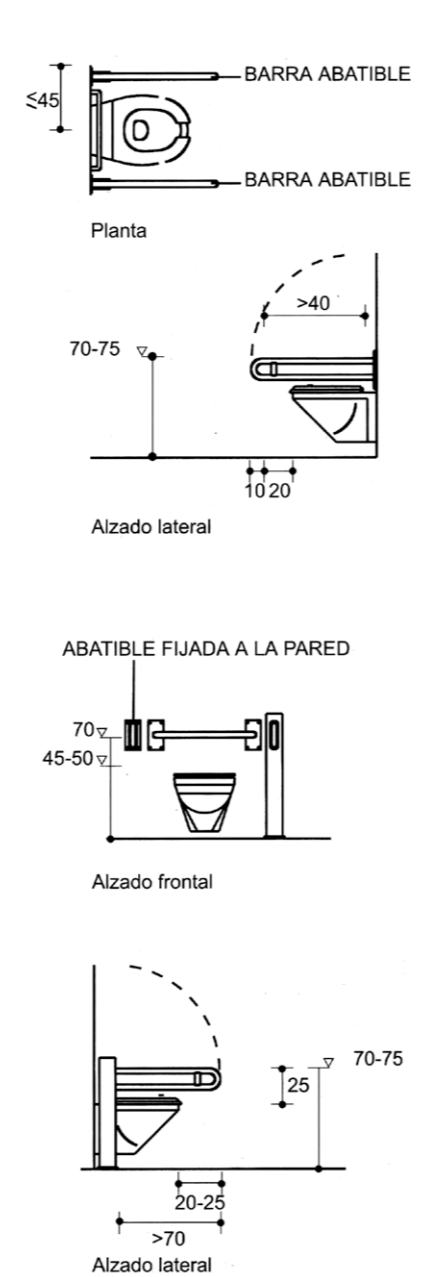

**BARRAS DE APOYO EN BAÑERAS**  
**GRAB RAILS IN WC BATH**

Con superficie de transferencia.  
*With transfer surface.*

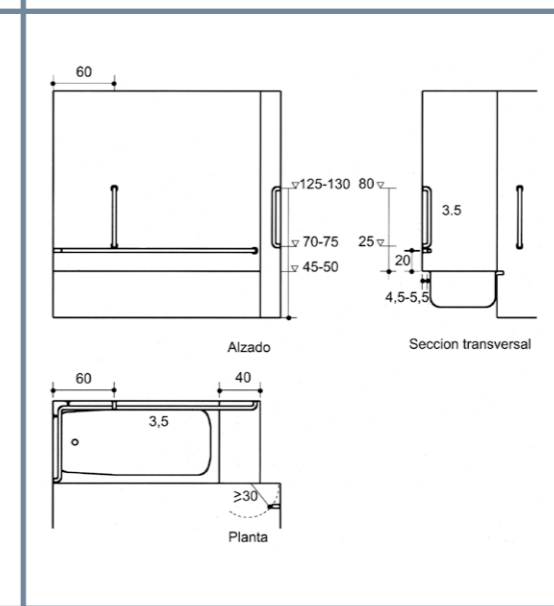
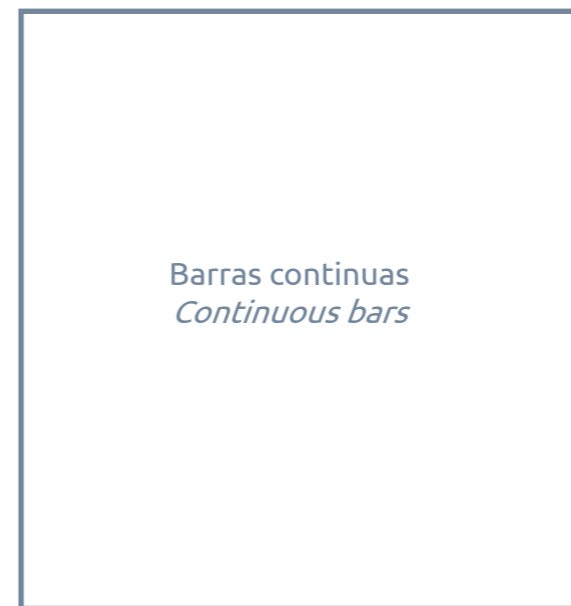

Sin superficie de transferencia.  
*With out transfer surface.*

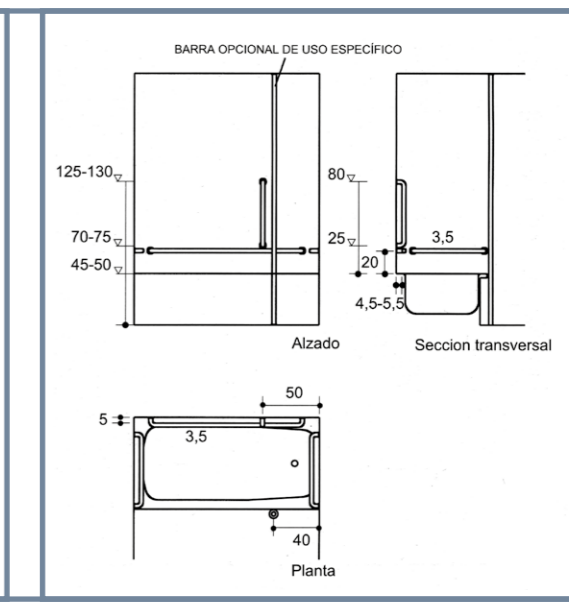
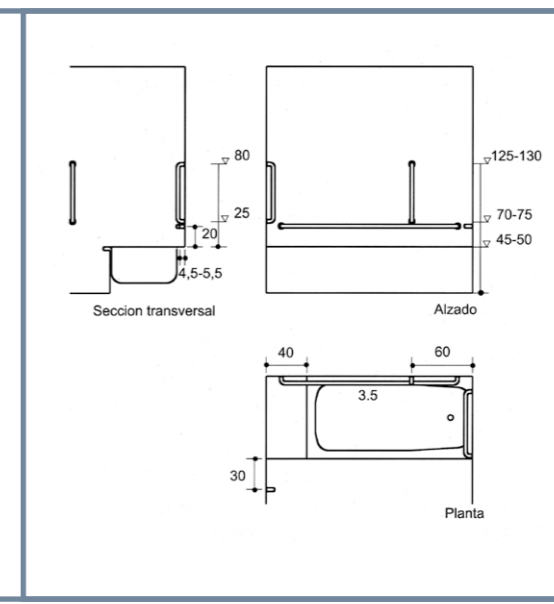
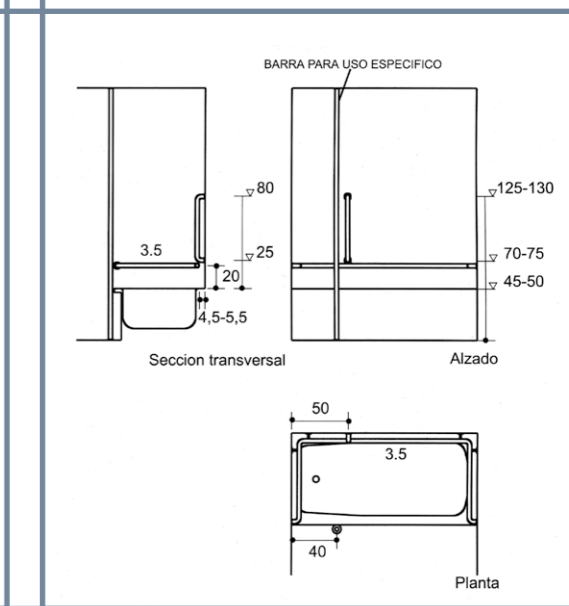

ASEOS PÚBLICOS: ESQUEMAS  
PUBLIC WC: DRAWINGS

Aseo compartido / Sharedtoilet

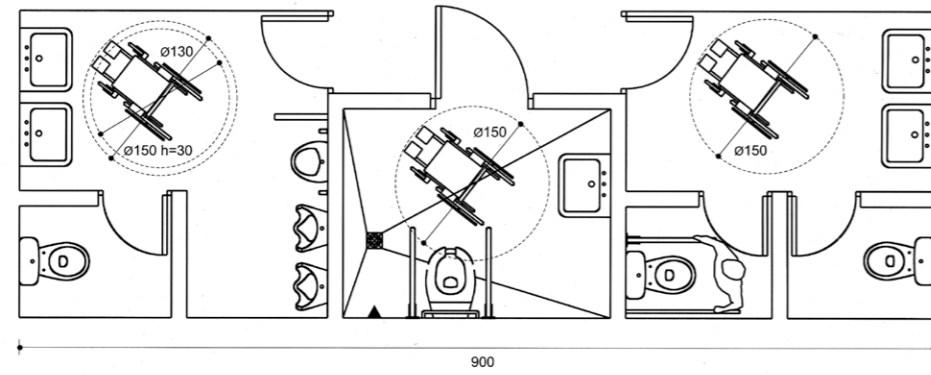

Aseos específicos / Specific toilets

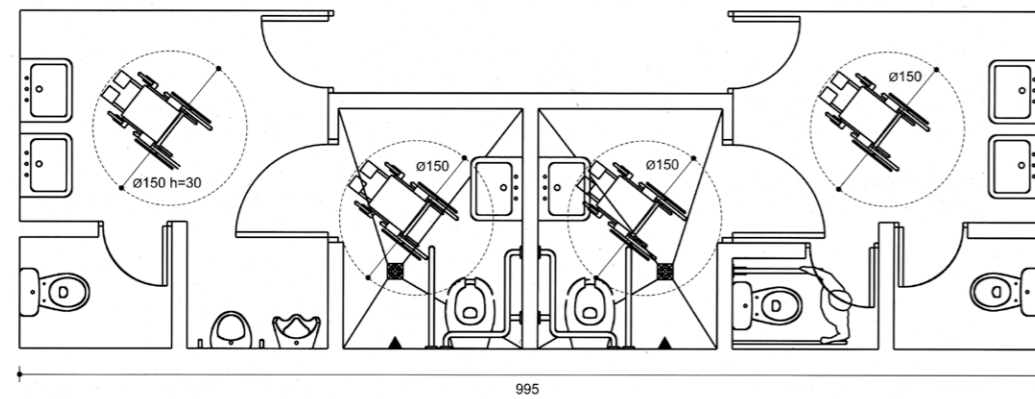

Aseo con solución mixta / Toilet with mixed solution

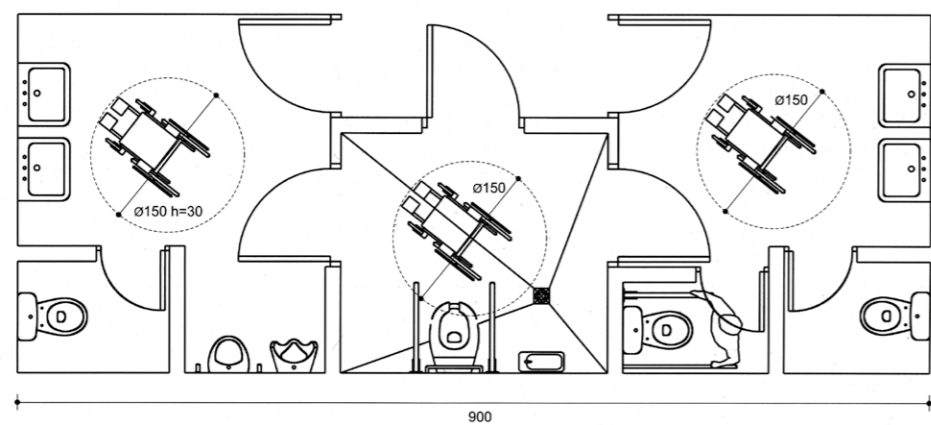



**Novotel**  
(Valencia, España)



**Radisson**  
(Bilbao, España)



**ZEL byMelía**  
(Girona, España)



**HardRock**  
(Tenerife, España)



**Hilton Garden Inn**  
(Tanger, Marruecos)



**Barceló Praha**  
(Praga, República Checa)



**BestSerenade**  
(Punta Cana, República Dominicana)



**The Signature Level at Grand Palladium**  
Sicilia (Sicilia, Italia)



**Grand Palladium Imbassai**  
(Bahía, Brasil)



**Four Seasons Casablanca**  
(Casablanca, Marruecos)



**RIU Plaza New York Times Square**  
(New York, EE.UU.)



**Wish Hotel da Bahia**  
(Bahia, Brasil)



**Grand Palladium Jamaica**  
(Lucea, Jamaica)



**Barceló Emperatriz**  
(Madrid, España)



**TheRitz-Carlton Tenerife, Abama**  
(Tenerife, España)



**Melia Trinidad Península**  
(Trinidad, Cuba)



**Danubius Helia**  
(Budapest, Hungría)



**Esana Thermal Aqua**  
(Heviz, Hungría)



**Danubius Anabella**  
**Balatonfured, Hungría**



**Hilton Garden Inn Padova**  
**(Padua, Italia)**



**Melia Aachen**  
**(Aachen, Alemania)**



**Melia Frankfurt**  
**(Frankfurt, Alemania)**



**Hotel Majestic**  
**(Burdeos, Francia)**



**Melia Amsterdam**  
**(Ámsterdam, Países Bajos)**



**Hotel Le Dimitile**  
**(Réunion, Francia)**



**Elite Palace**  
**(Estocolmo, Suecia)**

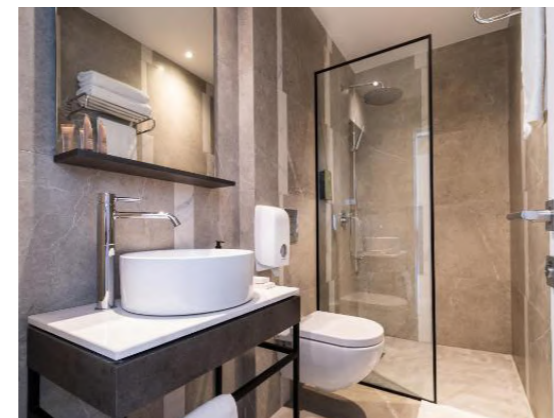

**Alinea Hotel**  
**(Limassol, Chipre)**



# Ghessu



C/ Dinamarca, 43  
Pol. Ind. La Casaza  
50180 UTEBO (Zaragoza)  
Tel: +34 976 775 757

Apdo. Correos, 23  
50620 CASETAS (Zaragoza)

[comercial@ghessu.com](mailto:comercial@ghessu.com)  
[www.ghessu.com](http://www.ghessu.com)